



INSTALLATION INSTRUCTIONS

24" x 48" Panel Frame Kit

Please read entire instruction sheet before you begin.

Follow these instructions and recommendations to install panels within warranty, and to avoid product damage.

Suitable for pro builders and DIY crafters.

Installation requires 2 people.

PLEASE READ INSTRUCTIONS COMPLETELY BEFORE YOU BEGIN: We recommend following best building practices for installing OUTDECO Steel Posts and Frames with OUTDECO Decorative Panels in accordance with their intended purpose. Examples shown in this document are installation suggestions. Adjust installation configurations to meet your specific project requirements. If in doubt, consult a professional. We recommend checking with proper authorities about building codes/standards that may apply to your project. The OUTDECO Post & Frame System has a 5-Year Limited Warranty for material integrity when installed per these instructions. Installers assume responsibility for the installation (See page 4).

Illustrations not to scale. Black posts and channels rendered in gray.

08-23

System Components & Features

Frame Channels

- Channels assemble into frames to hold 3 - 24" x 48" Panels
- Channel slots directly align with pre-drilled holes on OUTDECO USA posts (Fig. 1).
- Channel slots allow for up to 1" of vertical adjustment to compensate for uneven surfaces (Fig. 1).
- Channels also attach to existing walls, fences, and other flat surfaces (Fig. 2).

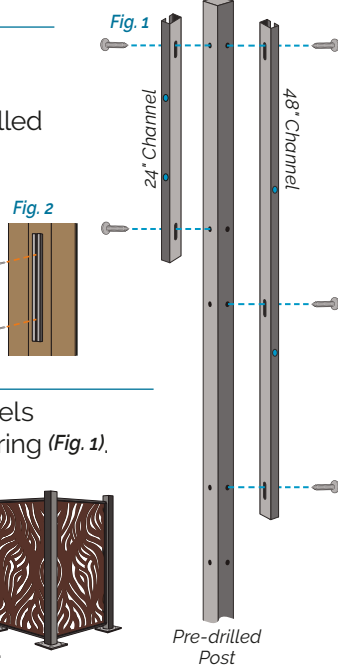

Posts (Sold separately.)

- Pre-drilled post holes and frame channels align for easy assembly without measuring (Fig. 1).
- Posts are pre-drilled on 3 sides allowing for linear or 90° corner installations (Fig. 3).
- See post instructions* for additional installation details and for 96" In-Ground Post installations.



* Post screws for both masonry and wood are included with posts. (Instructions & hardware are inside post.)

WHAT'S IN THE BOX

QTY. ITEM See pages 2 & 4 for channel identification diagrams.

- 3 A-24 Channels – 24" LEFT SIDE or UPPER Channels
- 3 B-24 Channels – 24" RIGHT SIDE or LOWER Channels
- 3 A-48 Channels – 48" LEFT SIDE or UPPER Channels
- 3 B-48 Channels – 48" RIGHT SIDE or LOWER Channels
- 12 Corners – Poly Frame Corner Connectors
- 12 Channel Screws – #8 x 1" Phillips
- 24 Panel Locking Screws – #8 x 1" Phillips

NOTE: Post screws for both masonry and wood are included with posts. (Instructions & screws are located inside the post.)

WHAT YOU'LL NEED

See Shopping List below for panel and post needs.



** Block height: Horizontal Panels (p. 2) – 7/8"H; Vertical Panels (p. 4) – 2 3/4"H
Cardboard blocks are included, but wood blocks are recommended.

Plan Your Design & Fence Configuration

Read this entire section before planning your project.

FENCE LOCATION – IMPORTANT!

Installing fencing under eaves, patio cover, pergola, etc., requires 2½-to-3 feet of clear space above the posts in order to insert the panels. Without clear space, assemble kits and insert panels lying on a flat surface. (Instructions on p. 2)

PATTERN ORIENTATION

Rotate panels to create unique patterns (Fig. 4). Check for pattern repeats and flows as you plan your design.

Lay out your panels in position on a flat surface before starting your project.

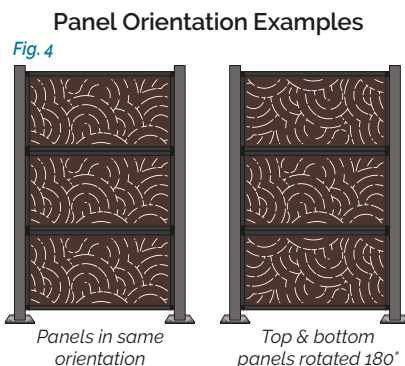

FENCE CONFIGURATIONS & SHOPPING LIST

1 Panel Frame Kit – 3 Stacked Horizontal Panels (Instructions on page 2.)

- 3 - 24" x 48" OUTDECO USA Decorative Panels (sold separately)
- Posts* (sold separately):
 - 2 - 75" Posts for 1st Frame Kit (Fig. 5)
 - 1 additional Post for each Frame Kit added to fence (Fig. 6)



1 Frame Kit + 2 - 75" Posts



2 Frame Kits + 1 add'l 75" Post

1 Panel Frame Kit – 3 Vertical Panels (Instructions on page 4.)

- 3 - 24" x 48" OUTDECO USA Decorative Panels (sold separately)
- Posts (sold separately):
 - 4 - 52" Posts for 1st Frame Kit (Figs. 7 & 8)
 - 3 additional 52" Posts for each Frame Kit added to fence



1 Frame Kit + 4 - 52" Posts



1 Frame Kit + 4 - 52" Posts

Learn more about OUTDECO USA panels and find design ideas at outdecousa.com.



48" x 24" Horizontal Panel Fencing – on 75" or 96" Posts

1. Identify Channels & Posts

Channel FRONTS & BACKS (Figs. 9-12)

Channel FRONTS (Fig. 9) have no holes and **face the front** of the fence (Fig. 10).

Channel BACKS (Fig. 11) have round holes and **face the back** of fence (Fig. 12).

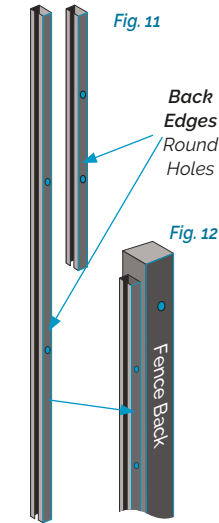
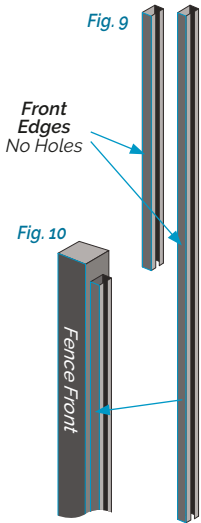

Channel Identification – Horizontal Panel Fence (See page 4 for vertical fence channels.)

- Lay out channels as shown at right (Fig. 13).
- Make sure the positions of long slots and round holes on your channels match the diagram at right (Fig. 13).

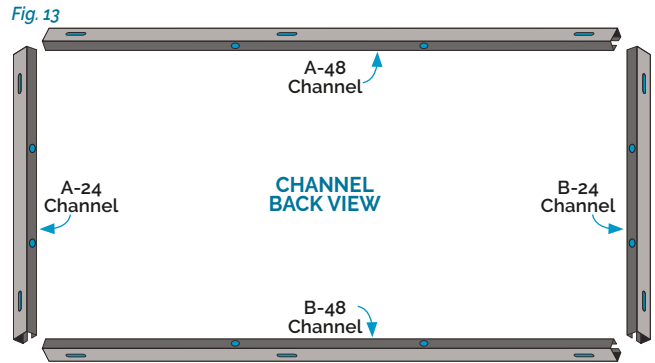

Post Positions

- Posts are pre-drilled with holes on 3 sides. Position the side with no holes as the front of your fence (Fig. 10).
- **IMPORTANT:** Stand facing the **BACK** of your posts:
 - A Channels will mount to the Post on your **LEFT** (Fig. 14).
 - B Channels will mount to the Post on your **RIGHT** (Fig. 14).

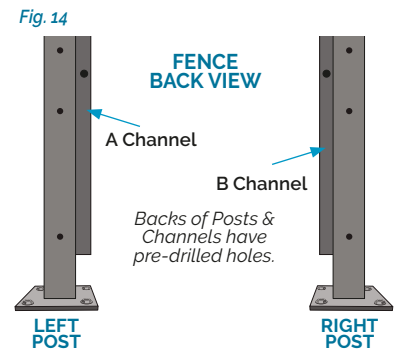

2. Assemble 3 Frames – Side & Lower Channels only

- Lay one **A-24 Channel** and one **B-24 Channel** facing each other (Fig. 13).
- Insert **Corners** (Fig. 15) into the lower ends and connect to each end of lower **B-48 Channel** (Fig. 15).
- Tap **Corners** gently with rubber mallet.

- Insert Corners into each end of the upper **A-48 Channel**. **Do not add upper A-48 Channel to the frame yet.**
- Repeat for all 3 frames.

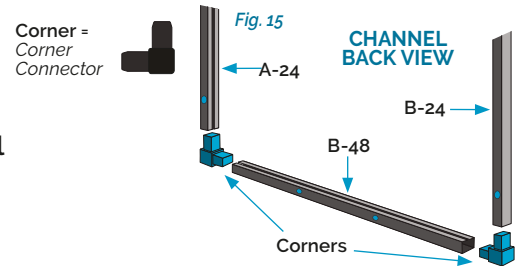

3. Install 1st Post

- Insert **Post Caps** on top of posts.
- Install **1st Post only** to concrete or wood surface. Check that post is straight and bolt down with the 4 post screws* (Fig. 16).
- Position 2nd post approx. 48" from 1st post. **Do not attach to surface yet.** Have a helper hold the post steady during **Steps 4, 5, & 6.** (Fig. 16).
- For **96" In-Ground Posts**, see post installation instructions.

* Instructions, post caps, and screws for both masonry and wood are included with posts (located inside post).

PRO TIP

If needed, add shims under post plate to level.

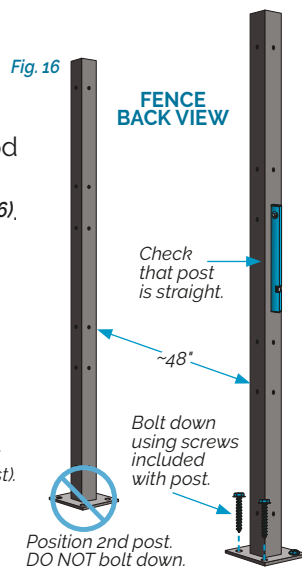

4. Attach 1st Frame to Posts

- Using an impact driver, **loosely** drive a **Channel Screw** through **A-24** and **B-24** upper slots into both posts. Add screws through lower slots (Fig. 17). **Do not tighten screws.**
- Position **7/8" H wood support blocks*** under frame corners to support the panel during installation.
- Check level on lower **B-48 Channel**.
- Adjust **A-24** and **B-24 Channels** vertically (max. 1") to compensate for uneven surfaces (Fig. 17).
- Drive screws in securely. **Do not overtighten screws.**

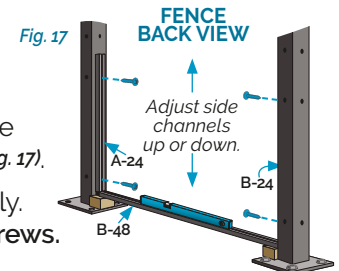

5. Insert & Secure 1st Panel

- **Slowly** slide a panel into the side **A-24** and **B-24 Channels**. **Do not drop in the panel.** Seat the panel securely into the lower **B-48 Channel** (Figs. 18 & 19).
- Slide upper **A-48 Channel** onto the top of the panel, gently tapping **Corners** into the side channels with a rubber mallet (Fig. 18). Check frame level.

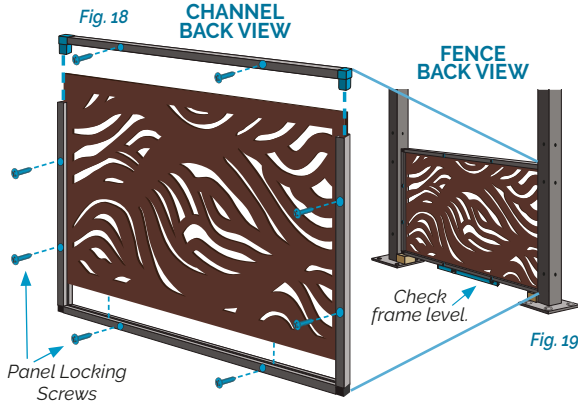

- **IMPORTANT!** Before the next step, check that panel fits snugly all the way into the channels and that corner connectors are completely inserted.
- Secure the panel in the frame (Fig. 18):
 - On the back of the frame, drive **Panel Locking Screws** into the panel through the holes in the lower **B-48 Channel**. **Do not overtighten.**
 - Drive screws through holes in the side **A-24** and **B-24 Channels**, starting with the lower holes.
 - **Check frame level again.** Drive screws through holes in the upper **A-48 Channel**.

6. Install 2nd Post

The width of the 1st installed frame determines spacing for the 2nd post. Check that channels and posts are level.

- Remove support blocks
- **Loosely** screw in 4 post screws (Fig. 20). **Do not tighten until all frames are installed.**

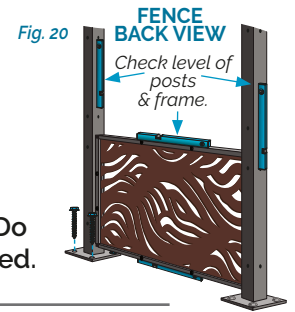

7. Install 2nd & 3rd Frames & Panels

- Repeat **Step 4**, positioning bottom of each frame flush with top of frame below (Fig. 21).
- Repeat **Step 5** to insert panels and secure with **Panel Locking Screws** (Figs. 18 & 22).
- Check that channels and posts are level to finalize accurate post placement. Tighten post bolts.

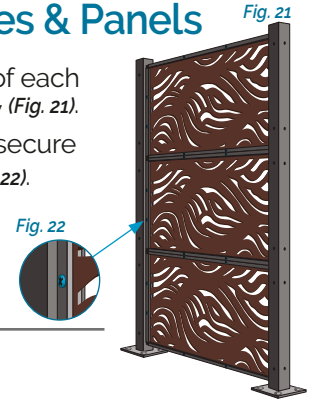

8. Finish Fencing

- To add sections for linear or corner installations, repeat all steps, screwing channels onto previous posts (Fig. 23).
- Once fence is finished, insert **Post-Hole Plugs** (included with posts) into unused post holes to help prevent water from leaking into posts (Figs. 23 & 24).

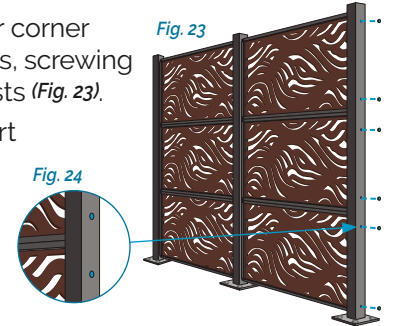

48" x 24" Horizontal Panel Fencing – Assembled Lying on a Flat Surface

Use this method for installing fencing in a location (under eaves, patio cover, pergola, etc.) without 2½-to-3 feet of clear space above the posts for inserting the panels.

1-2. Identify Channels & Assemble Frames

- Follow **Steps 1 & 2** on page 2 – lay out channels and assemble frames.

3. Position Posts

- Insert **Post Caps** on top of posts (included with posts).
- Posts are drilled on 3 sides. The un-drilled side is the front of your fence. Lay 2 posts un-drilled side facing down, approx. 48" apart on a flat surface. Add 2" support blocks under ends of posts (Fig. 25).

4-5 & 7. Install Frames & Panels

- Follow **Steps 4, 5 & 7** (skip Step 6) to install frames and panels. Level posts and channels as you go.

7a. Install Posts

- With a helper, stand posts and frame upright. **Be very careful not to bend frame channels.**
- The width of the installed frames determines spacing for posts.
- Carefully check levels on all channels and posts to ensure accurate post placement.
- Bolt down each post with 4 post screws* (Fig. 26).

* Instructions, post caps, and screws for both masonry and wood are included with posts (located inside post)

8. Finish Fencing

- Follow **Step 8** above to add sections to your fence and add **Post Hole Plugs**.

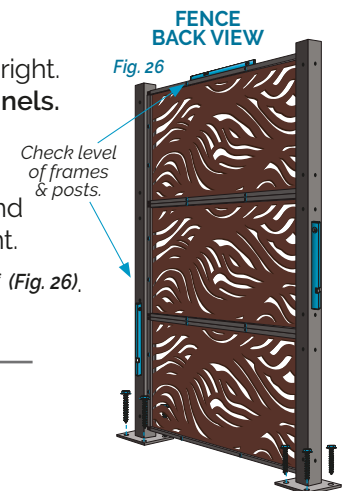
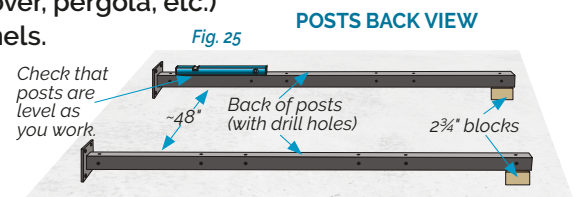

24" x 48" Vertical Panel Fencing – on 52" Posts

1. Identify Channels & Posts

Channel FRONT & BACKS

- See page 2 (Fig. 13) for channel front/back identification.

Channel Identification for Vertical Panel Fence (See page 2 for horizontal layout.)

- To identify your channels, lay them out like the diagram at right (Fig. 27).
- Check that the placement of the long slots and 2 round holes match the positions in the diagram (Fig. 27).

Post Positions

- See page 2 (Fig. 14) for post positions.

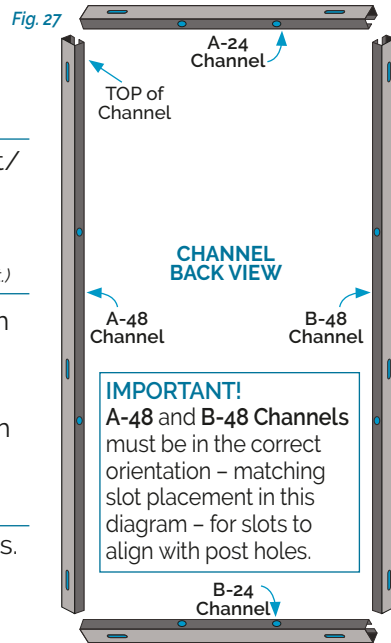

2. Assemble Frames – Side & Lower Channels

Partially Assemble All 3 Frames

- Lay an A-48 Channel and a B-48 Channel facing each other (Fig. 27). Insert Corners (Fig. 25) into the lower end of each one.
- Connect to a lower B-24 Channel (Fig. 28). Tap Corners gently with rubber mallet.
- Insert Corners into ends of an upper A-24 Channel. Do not add upper A-48 Channel to frame yet.

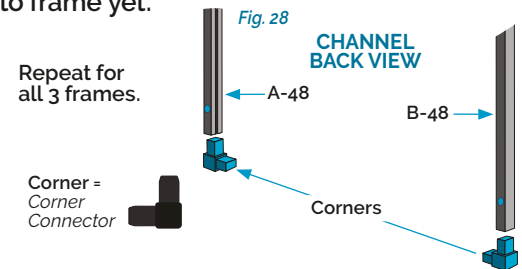

3. Install 1st Post

- See Step 3 on page 2, but position 2nd post approx. 24" from 1st post.

4. Attach Frame to Posts

- Using an impact driver, *loosely* drive a Channel Screw through A-48 and B-48 Channels' upper slots into both posts (Fig. 29). Do not tighten screws.
- Add screws through all other slots (Fig. 29).
- Position 2¾"H blocks below frame corners to support the panel's weight during installation (Fig. 29). Do not tighten screws.
- Level lower B-24 Channel and adjust A-48 and B-48 Channels vertically (max. 1") to compensate for uneven surfaces (Fig. 29).
- Drive screws in securely. Do not overtighten screws.

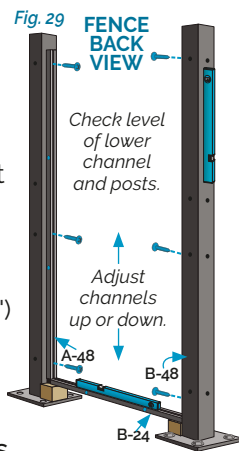

5. Insert Panel

- Slowly* slide panel into side A-48 and B-48 Channels. Do not drop it in! Seat the panel securely into the lower B-24 Channel (Figs. 30 & 31).
- Slide upper A-24 Channel onto top of panel (Fig. 30), gently tapping Corners into side channels with rubber mallet. Check frame level.
- IMPORTANT!** Before next step, check that Panel fits snugly all the way into Channels and Corner Connectors are completely inserted.
- Secure the panel in the frame (Fig. 30):
 - On back of frame, drive Panel Locking Screws into panel through holes in lower B-24 Channel.
 - Add screws through holes in side A-48 and B-48 Channels, starting with the lower holes.
 - Check frame level. Add screws through holes in upper A-24 Channel.

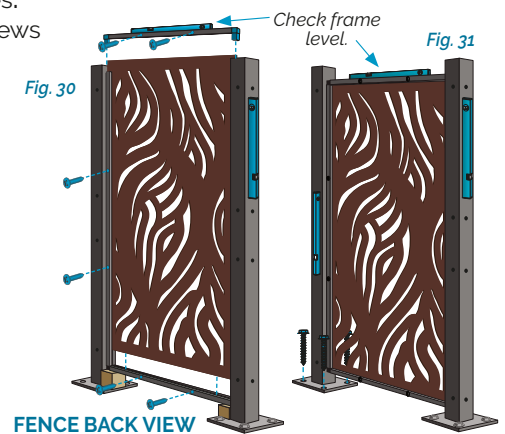

6. Install 2nd Post

Installed frame determines spacing for the 2nd post.

- Remove support blocks.
- Loosely* screw in 4 post screws (Fig. 31).
- Check level of channels and posts to finalize accurate post placement. Tighten post screws.

7. Finish Fencing

- Repeat Step 4 to add the other 2 frames and panels in linear (Fig. 32) or corner (Fig. 34) configurations, attaching channels to installed posts. Continue with Steps 5 & 6.
- Once fence is finished, insert Post-Hole Plugs (included with posts) into open holes to help prevent water leaking into posts (Figs. 32 & 33).

