

LACAVA

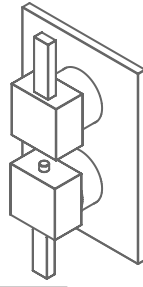

KUBISTA built-in thermostatic valve with 3-way diverter 14TH3.L.S

Specifications:

Installation:	built-in wall mount
Exterior Dimensions:	W: 5 1/8" H: 7 1/4"
Material:	solid brass construction with thermostatic cartridge and diverter ceramic cartridge with 3-way out
Water use:	6.1 GPM (43.5 PSI)
Finishes:	CR - polished chrome NI - brushed nickel
Fittings included:	rough-in # VTH3 and trim # 14TH3.L.S-A

Features:

- thermostatic valve with 3-way diverter and OFF function
- rectangular backplate
- lever handles
- 3/4" NPT water IN and 1/2" NPT OUT connections
- anti-scald protection & temperature regulation
- water temperature set to 100°F
- screwdriver service stops
- finished wall must be flush with mudguard as marked
- 1 1/8" extension kit available

Codes + Standards:

- Meets and exceeds applicable national codes and standards
- CAL-Green compliant

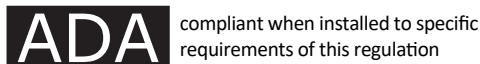

Recommended Items:

- Replacement parts:
 - VTH3 rough-in with 3-way diverter
 - 14TH3.L.S-A trim
 - VTH0-CT thermostatic cartridge
 - VTH3-C diverter ceramic cartridge with 3-way out
 - VTH3-EX 1 1/8" extension kit

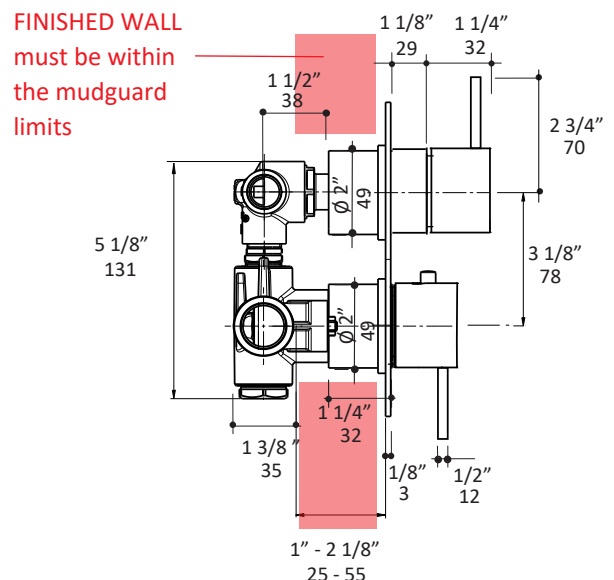
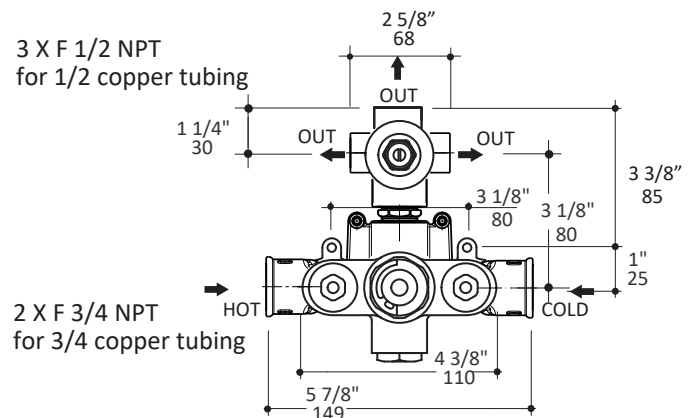
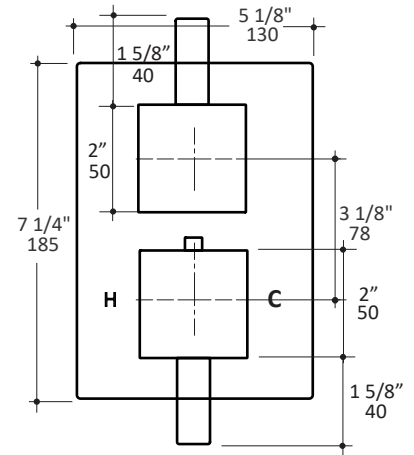

LACAVA reserves the right to revise any dimension or information on this sheet without notice. Dimensions are nominal and may vary within an industry accepted tolerance of 1/4". Drawings provided herein are meant to give the user an idea of the product and are not made to scale. Location of plumbing is meant for reference, your specific application may vary. Revised: 11/11/2020