













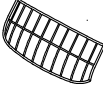

# ASSEMBLY INSTRUCTIONS

## Stationary Egg Chair

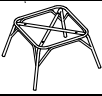
Avoid using sharp objects such as a knife to cut open packing as you may accidentally damage the upholstery.

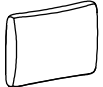
PARTS LIST			
ITEM	DESCRIPTION	SKETCH	QUANTITY
HW1	Bolt and washer and nut M6*55		9 PCS
HW2	Bolt and washer and nut M6*50		6 PCS
HW3	Bolt and washer M6*35		4 PCS
HW4	Bolt and washer M6*60		3 PCS
HW5	Wrench		1 PC
HW6	Allen Key		1 PC
A	Chair Back		1 PC
B	Chair Right Side		1 PC
C	Chair Left Side		1 PC
D	Chair Top		1 PC
E	Chair Seat		1 PC
F	Chair Base		1 PC
G	Seat Cushion		1 PC
H	Back Cushion		1 PC
I	Arm Cushion		2 PC

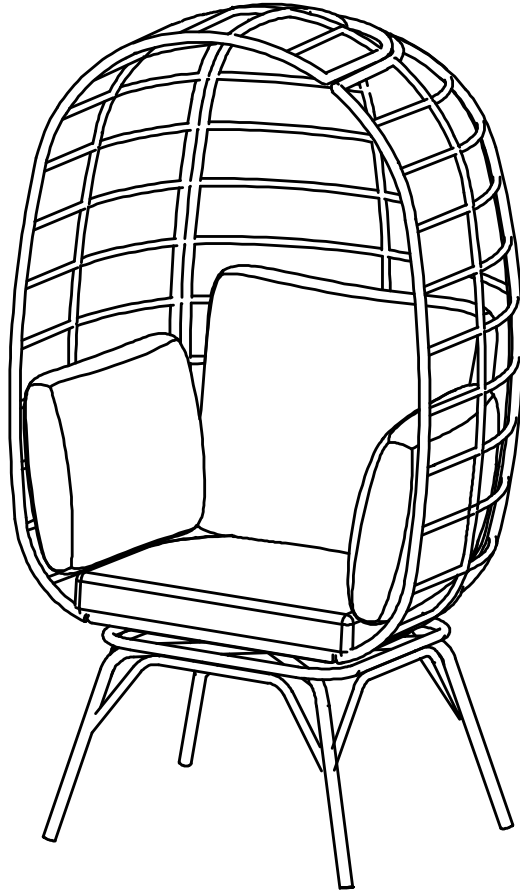

### ASSEMBLY INSTRUCTIONS

Do not fully tighten bolts until assembly is complete.

STEP 1

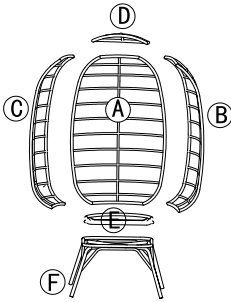

STEP 2

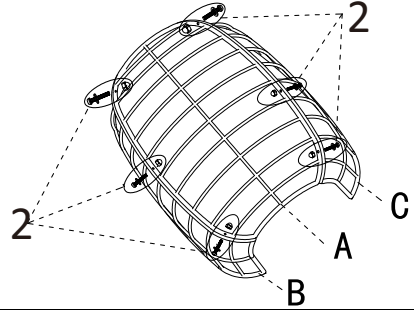

STEP 3

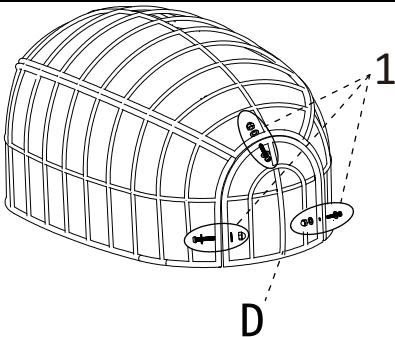

STEP 4

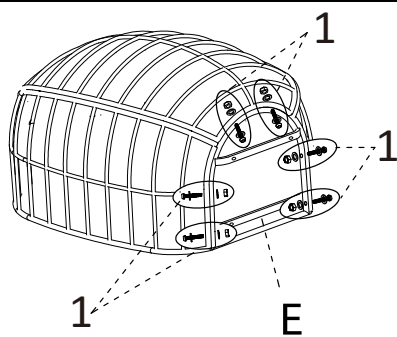

## ASSEMBLY INSTRUCTIONS

Do not fully tighten bolts until assembly is complete.

STEP 5

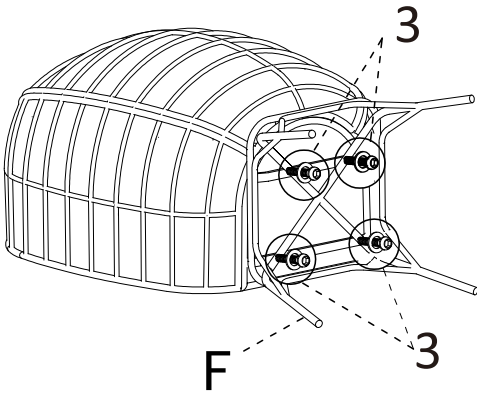

STEP 6

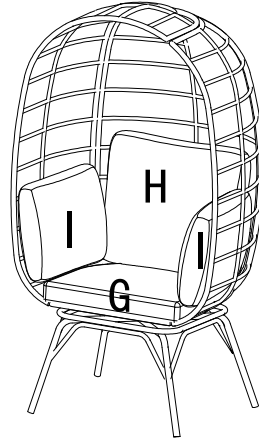

If the Bolts M6\*55 (HW1) are no long enough, please change to another Bolts M6\*60mm(HW4) for assembly.

**CLEANING INSTRUCTIONS:** clean with a softcloth, brush or lightly vacuum.

### ADULT ASSEMBLY REQUIRED

If you are missing any parts or have any questions regarding assembly, do not return this item to the retailers store. Please call our toll-free, customer service number and have this assembly manual open to the parts list ready to provide the model name, number and part name or number.



**WARNING:** This product may contain small components, please ensure they are kept away from small children.