

CUSTOMER DATA SHEET - SHOWER TRAYS

DESCRIPTION:

Rectangular Tray 1200X760x40

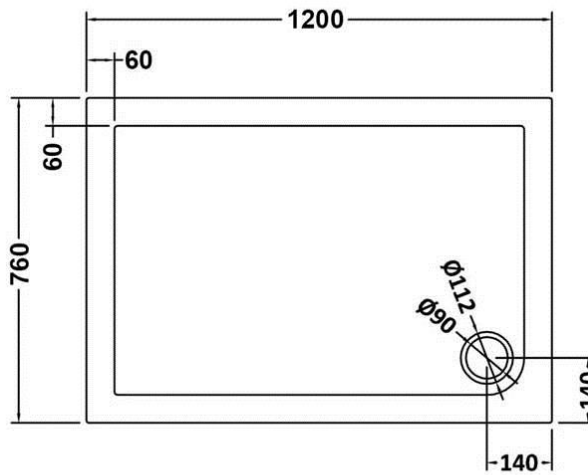

PRODUCT DIMENSIONS

Length (mm)	Width (mm)	Height (mm)	Nett Wgt Kg
1200	760	40	23.6

PACKAGING DIMENSIONS

Length (mm)	Width (mm)	Height (mm)	Gross Wgt Kg
1240	800	80	23.6

PACKAGING DATA

Box Colour	Shrinkwrap & Polystyrene		
Box Qty	1	Label Colour	White Label
Label Size	100 x 50	Label Qty	2

OUTER BOX DIMENSIONS (If Applicable)

Length (mm)	Width (mm)	Height (mm)	Gross Wgt Kg

PRODUCT DETAILS

Country of Origin	United Kingdom
Fitting Instruction	Yes
Product Material	Acrylic Capped ABS Caco3 & Pu
Mat' Colour Ref'	European White
Waste Required (mm)	90

CE Certification	Yes
Colour/Finish	White
Radius	0
Compatible with Leg Kit	Yes