

ASSEMBLY INSTRUCTION

Warning: You must read this before continuing

INSTRUCTIONS DE MONTAGE

Attention: Vous devez lire ceci avant de continuer

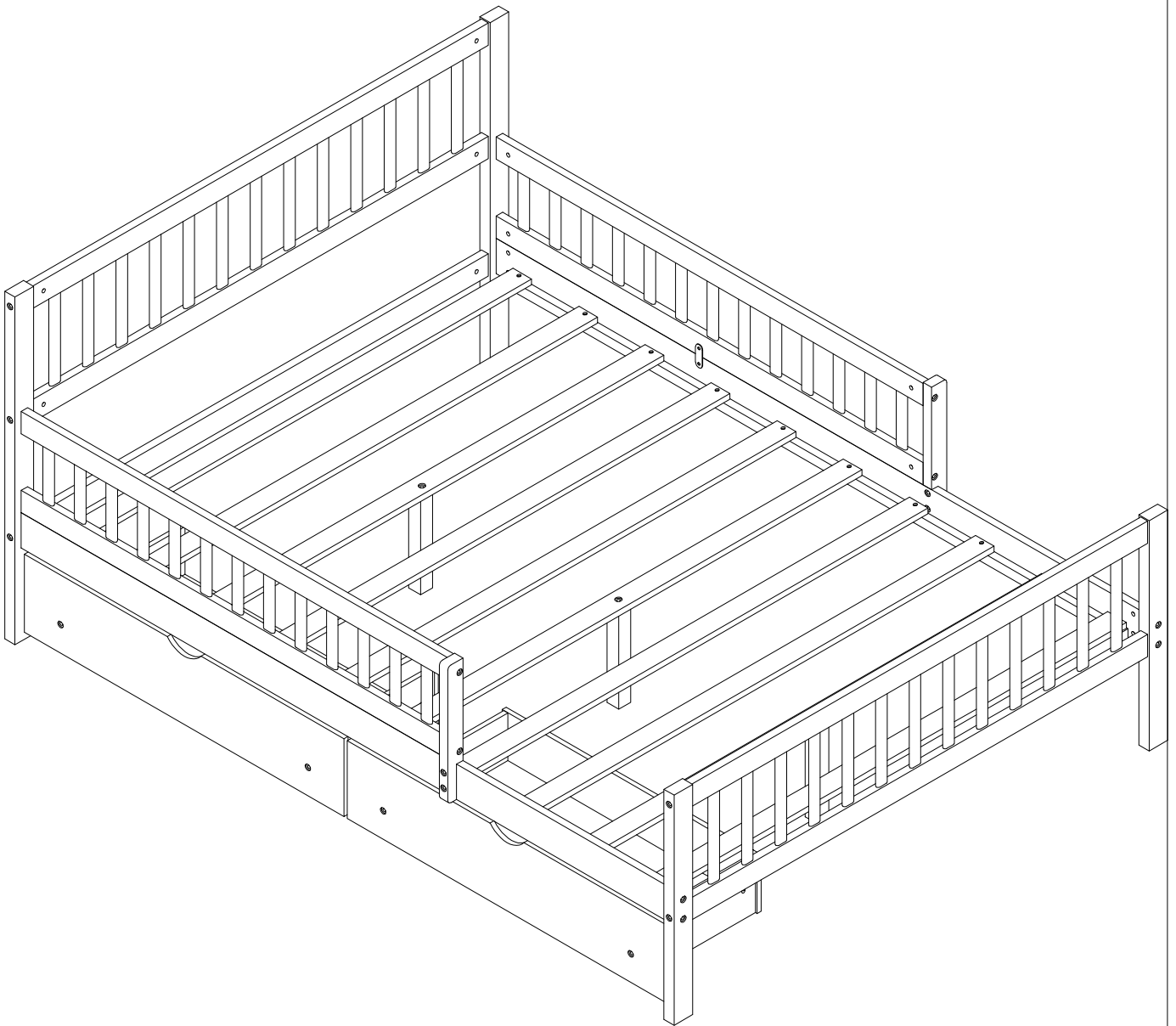

SAFETY WARNINGS AND GENERAL NOTES:

1. Do not use substitute parts. Contact the manufacturer or dealer for replacement parts.
2. Keep these instructions for future reference.
3. We recommend assembling your bed on the shipping carton to protect your floor.
4. Be certain all staples are out of the box before beginning assembly on the shipping carton.
5. Replacement Parts:
Replacement Parts, including additional guardrails, may be obtained from any of our

AVERTISSEMENTS DE SÉCURITÉ ET REMARQUES GÉNÉRALES :

1. N'utilisez pas de pièces de rechange. Contactez le fabricant ou le revendeur pour les pièces de rechange.
2. Conservez ces instructions pour référence future.
3. Nous vous recommandons d'assembler votre lit sur le carton d'expédition pour protéger votre sol.
4. Assurez-vous que toutes les agrafes sont sorties de la boîte avant de commencer l'assemblage sur le carton d'expédition.
5. Pièces de rechange :
Les pièces de rechange, y compris les garde-corps supplémentaires, peuvent être obtenues auprès de l'un de nos revendeurs





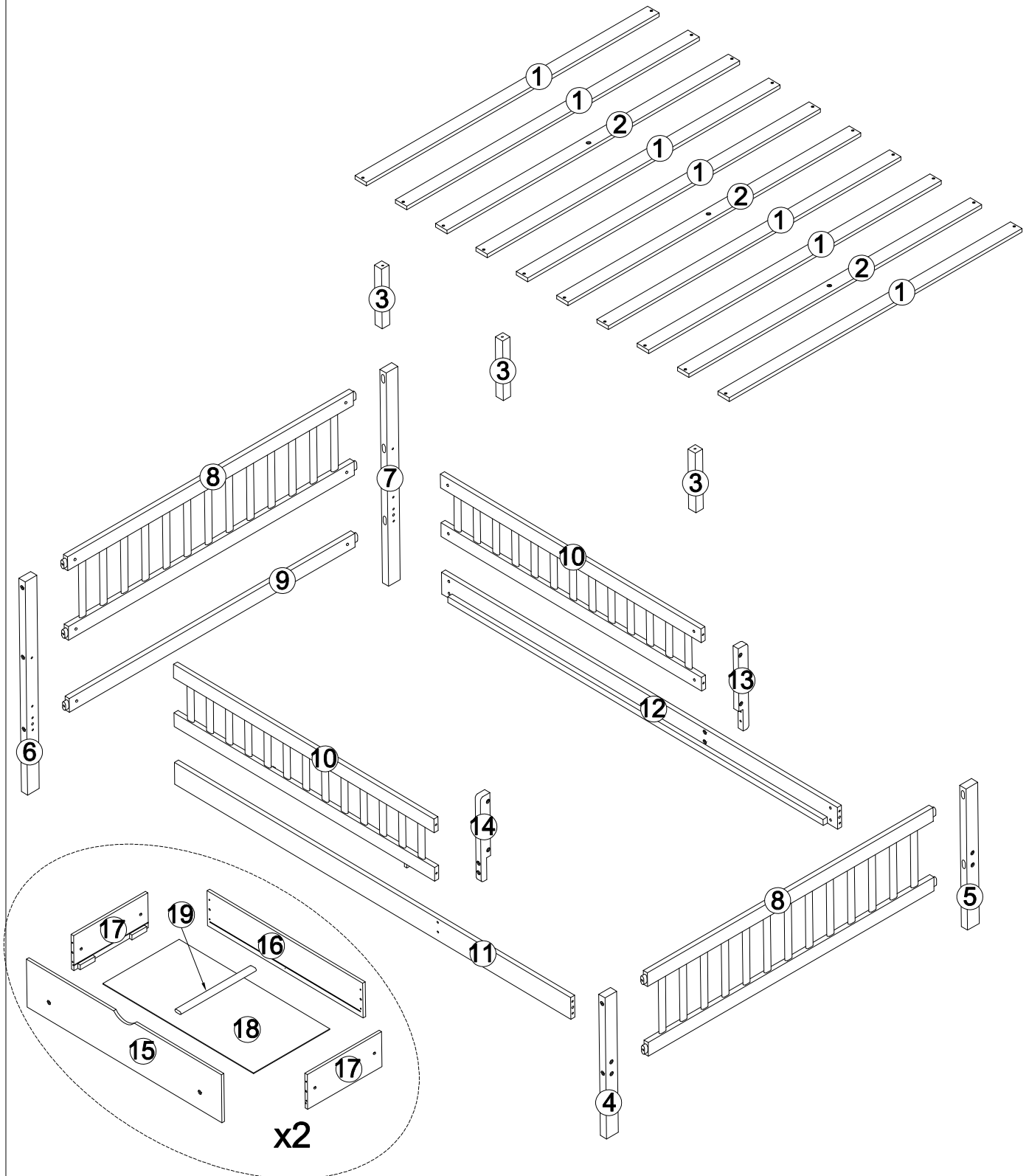



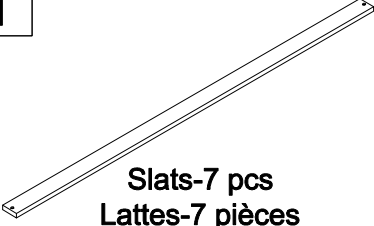
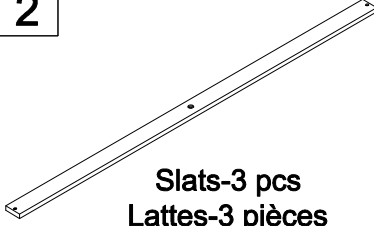

ASSEMBLY INSTRUCTION

INSTRUCTIONS DE MONTAGE



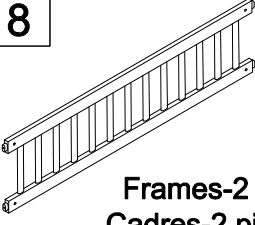
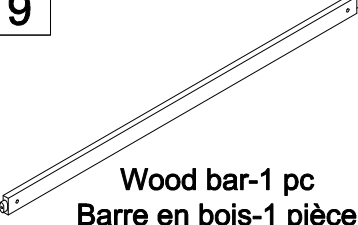
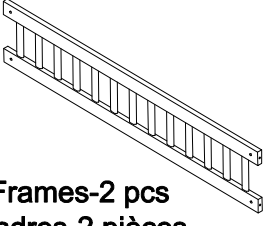
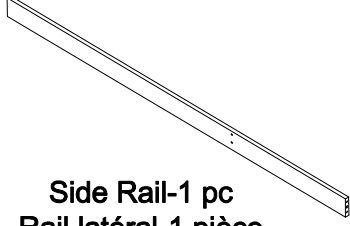
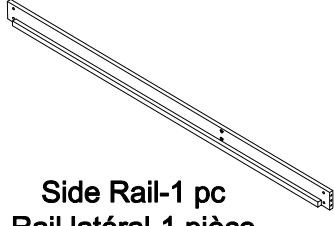

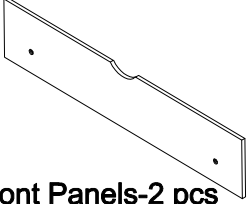

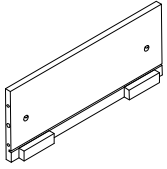
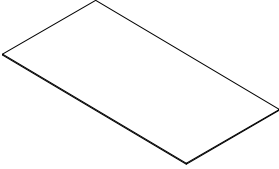
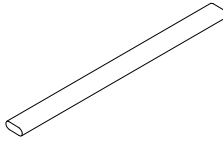
Part List

Liste des pièces

<p>1</p>  <p>Slats-7 pcs Lattes-7 pièces</p>	<p>2</p>  <p>Slats-3 pcs Lattes-3 pièces</p>	<p>3</p>  <p>Center Legs-3 pcs Pieds centraux-3 pièces</p>
<p>4</p>  <p>Leg-1 pc Jambe-1 pièce</p>	<p>5</p>  <p>Leg-1 pc Jambe-1 pièce</p>	<p>6</p>  <p>Leg-1 pc Jambe-1 pièce</p>
<p>7</p>  <p>Leg-1 pc Jambe-1 pièce</p>	<p>8</p>  <p>Frames-2 pcs Cadres-2 pièces</p>	<p>9</p>  <p>Wood bar-1 pc Barre en bois-1 pièce</p>
<p>10</p>  <p>Frames-2 pcs Cadres-2 pièces</p>	<p>11</p>  <p>Side Rail-1 pc Rail latéral-1 pièce</p>	<p>12</p>  <p>Side Rail-1 pc Rail latéral-1 pièce</p>
<p>13</p>  <p>Rail-1 pc Rail-1 pièce</p>	<p>14</p>  <p>Rail-1 pc Rail-1 pièce</p>	<p>15</p>  <p>Drawer-Front Panels-2 pcs Panneaux avant de tiroir-2 pièces</p>
<p>16</p>  <p>Drawer-Back Panels-2 pcs Panneaux arrière de tiroir-2 pièces</p>	<p>17</p>  <p>Drawer-Side Panels-4 pcs Panneaux latéraux de tiroir-4 pièces</p>	<p>18</p>  <p>Drawer-Bottom Panels-2 pcs Panneaux de fond de tiroir-2 pièces</p>
<p>19</p>  <p>Drawer-Support Bottom Panels-2 pcs Panneaux inférieurs de support de tiroir-2 pièces</p>		

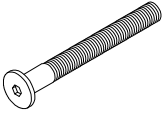
Hardware List

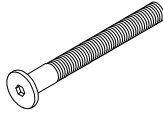
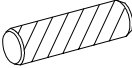
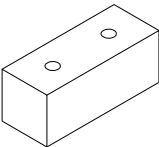
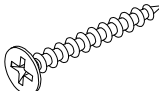

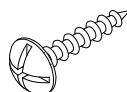
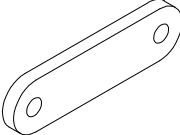
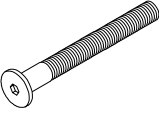
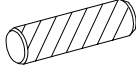
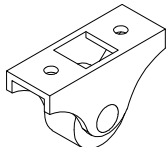
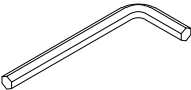
Liste du matériel

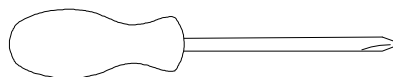
<p>A</p>  <p>Bolt Ø1/4" x 100 mm-10 pcs Boulon Ø1/4" x 100 mm-10 pièces</p>	<p>B</p>  <p>Ø1/4" x 13 mm -34 pcs Ø1/4" x 13 mm -34 pièces</p>	<p>C</p>  <p>Bolt Ø1/4" x 70 mm-16 pcs Boulon Ø1/4" x 70 mm-16 pièces</p>
<p>D</p>  <p>Wood dowel Ø10 x 40 mm-4 pcs Cheville en bois Ø10 x 40 mm-4 pièces</p>	<p>E</p>  <p>Stop Drawer-3 pcs Tiroir d'arrêt-3 pièces</p>	<p>F</p>  <p>Screws M4 x 30 mm-28 pcs Vis M4 x 30 mm-28 pièces</p>
<p>G</p>  <p>Bolt Ø1/4" x 35 mm-4 pcs Boulon Ø1/4" x 35 mm-4 pièces</p>	<p>H</p>  <p>Ø1/4" x 15 mm-4 pcs Ø1/4" x 15 mm-4 pièces</p>	<p>K</p>  <p>Screws M4 x15 mm-20 pcs Vis M4 x15 mm-20 pièces</p>
<p>L</p>  <p>Steel Bracket -2 pcs Support en acier -2 pièces</p>	<p>M</p>  <p>Bolt Ø1/4" x 50 mm-11 pcs Boulon Ø1/4" x 50 mm-11 pièces</p>	<p>N</p>  <p>Wood dowel Ø6 x 25 mm-16 pcs Cheville en bois Ø6 x 25 mm-16 pièces</p>
<p>P</p>  <p>Wheels (H=28mm)-8 pcs Roues (H=28mm)-8 pièces</p>	<p>Q</p>  <p>Allen Key-1 pc Clé Allen-1 pièce</p>	





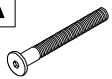

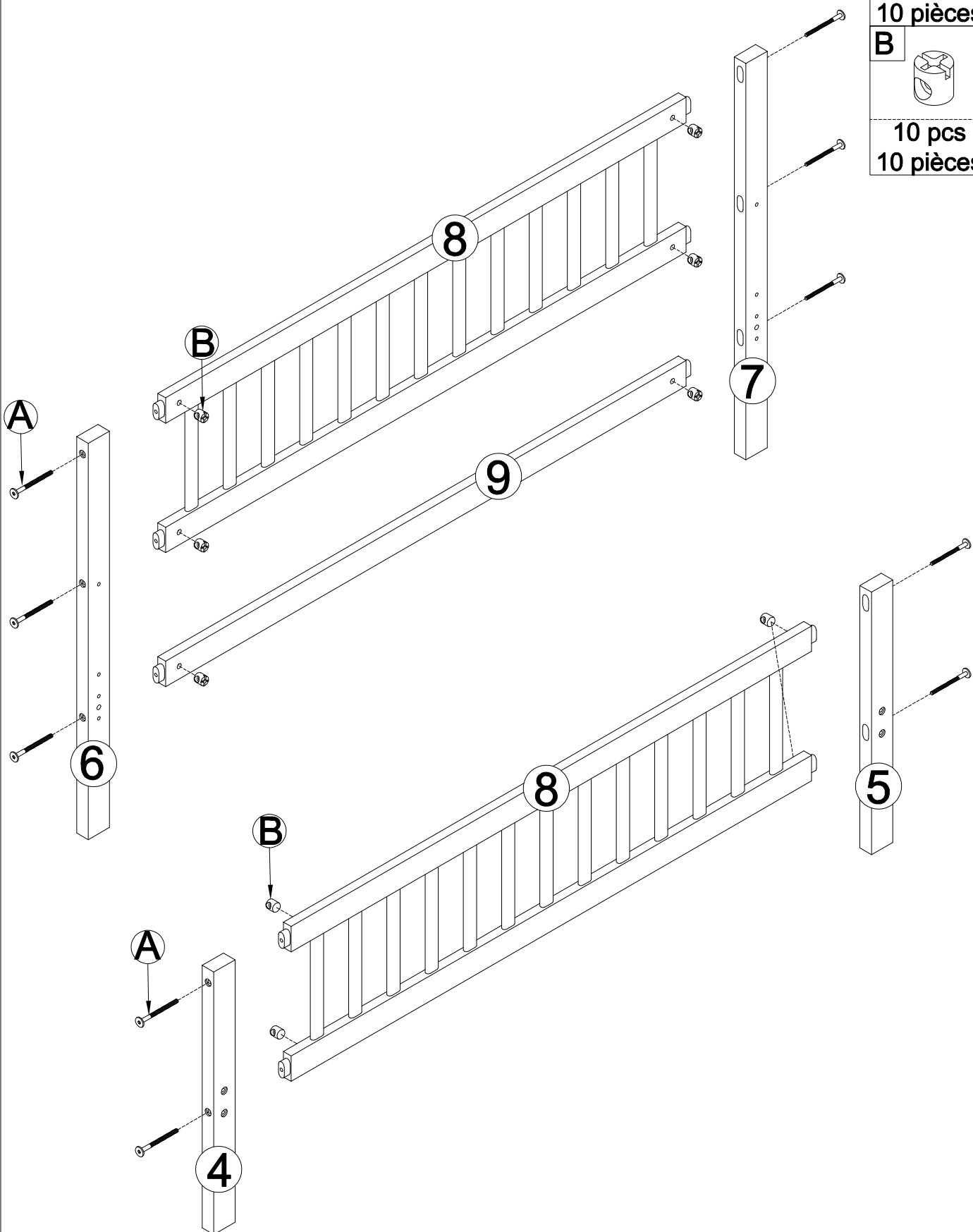

Assembly Tools Required (Not Included)
Outils d'assemblage requis (non inclus)

STEP 1:
ÉTAPE 1:

A	
	10 pcs 10 pièces
B	
	10 pcs 10 pièces

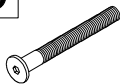

STEP 3:
ÉTAPE 3:

K 	B 	C 
4 pcs 4 pièces	8 pcs 8 pièces	8 pcs 8 pièces
L 	H 	G 
2 pcs 2 pièces	4 pcs 4 pièces	4 pcs 4 pièces

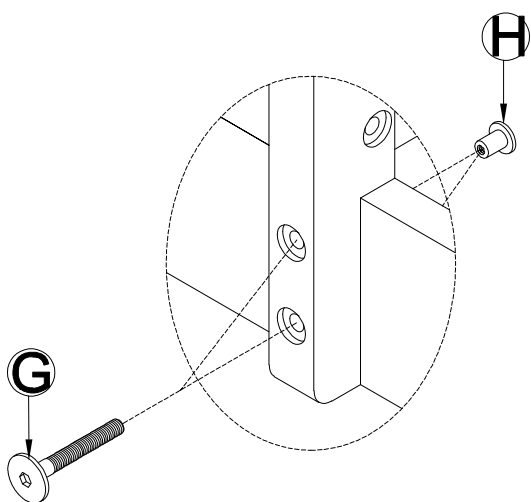
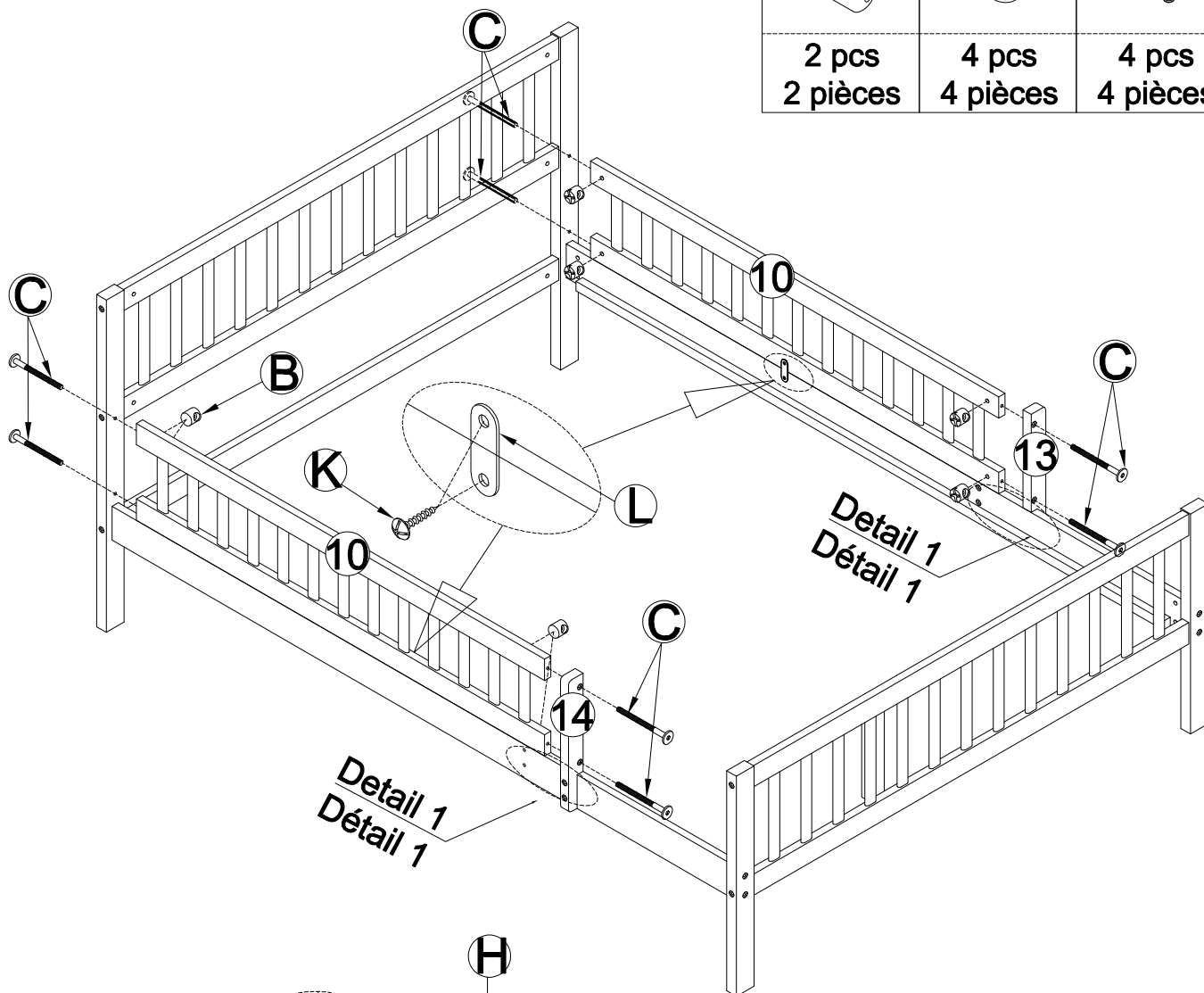

Detail 1(x2)
Détail 1(x2)

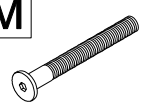

STEP 4:
ÉTAPE 4:

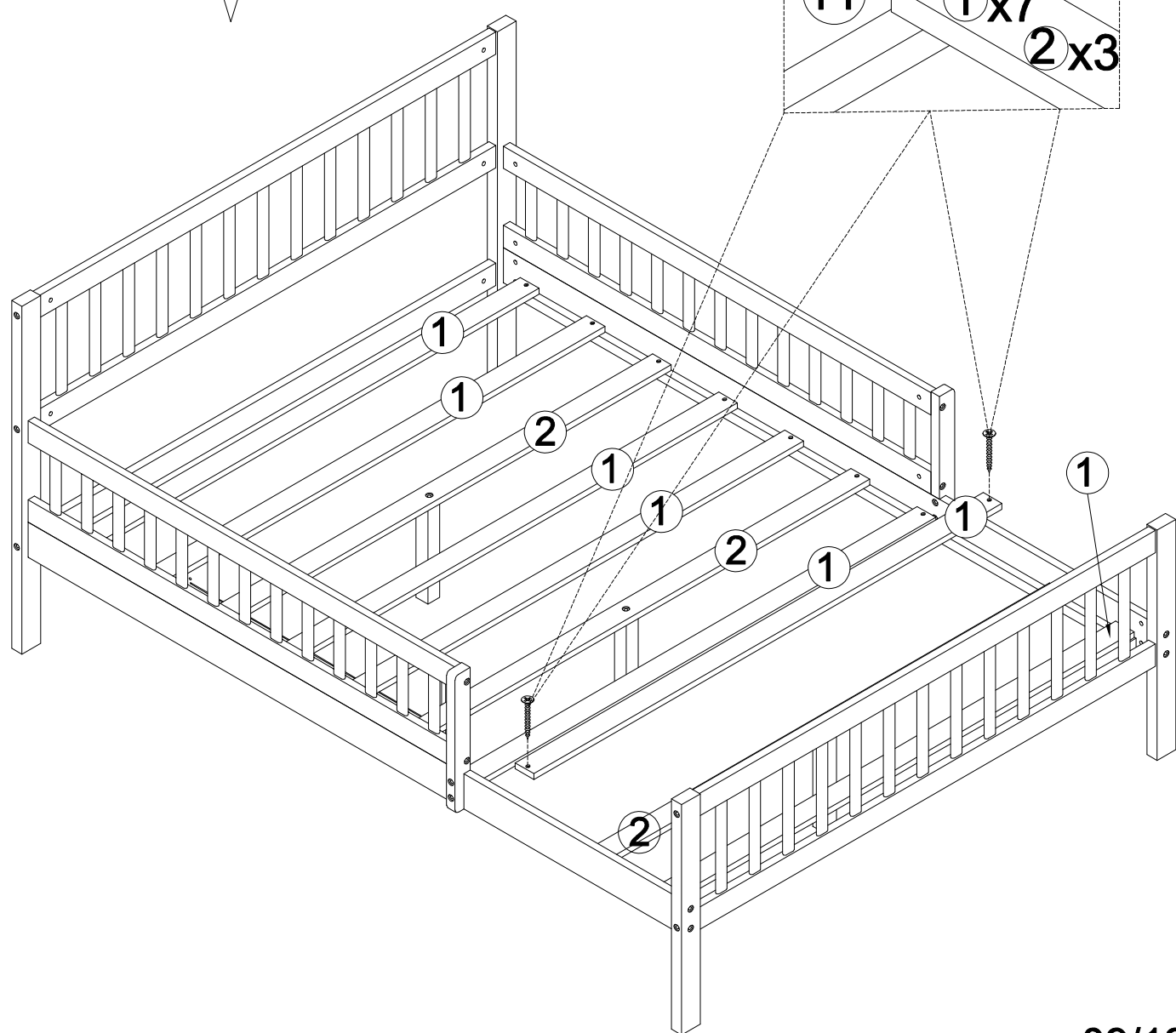
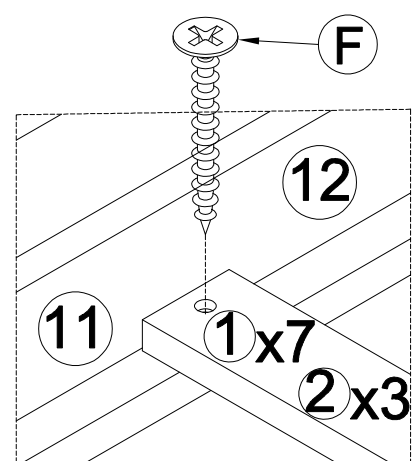
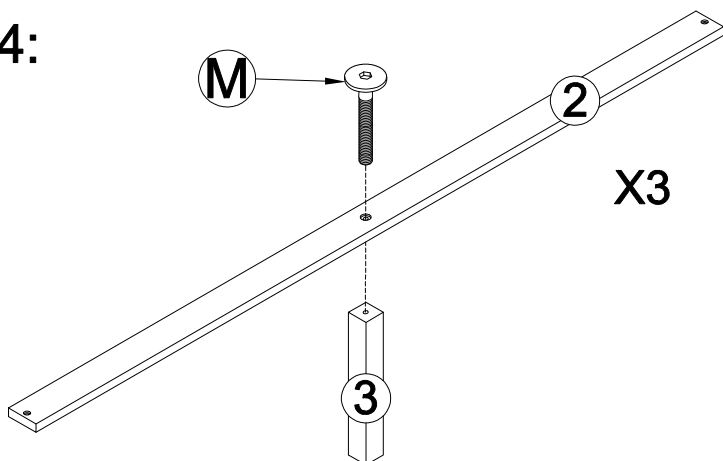
F		M	
	20 pcs 20 pièces		3 pcs 3 pièces

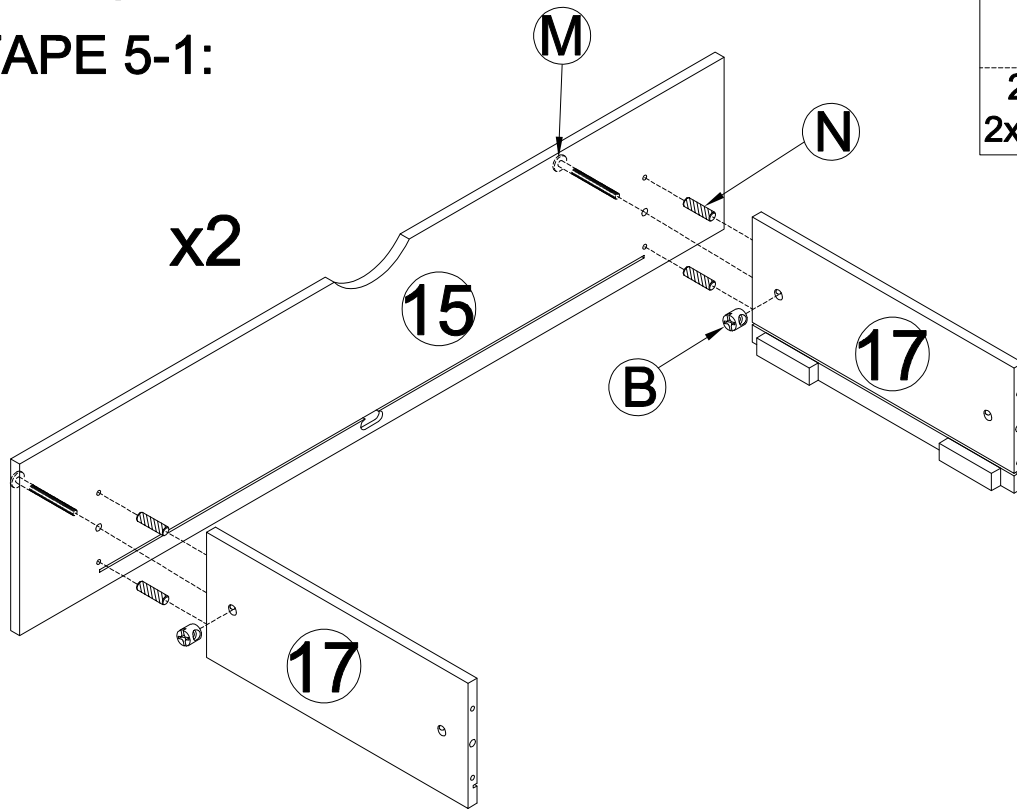

STEP 5-1:
ÉTAPE 5-1:

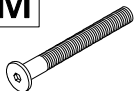

N		M	
2x4 pcs 2x4 pièces		2x2 pcs 2x2 pièces	
		B	
		2x2 pcs 2x2 pièces	

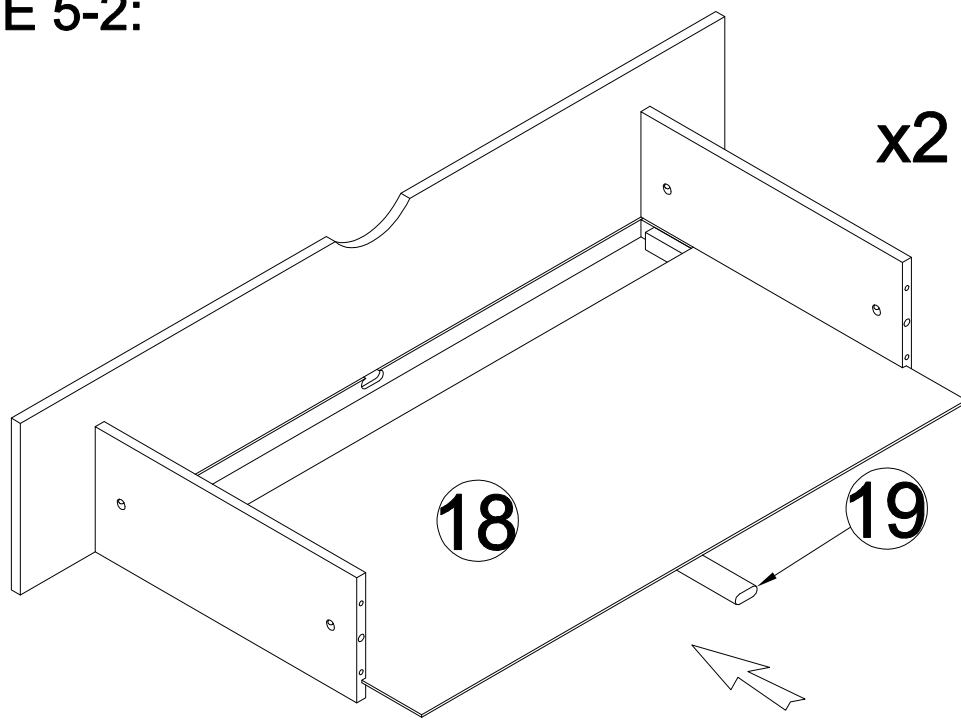

STEP 5-2:
ÉTAPE 5-2:

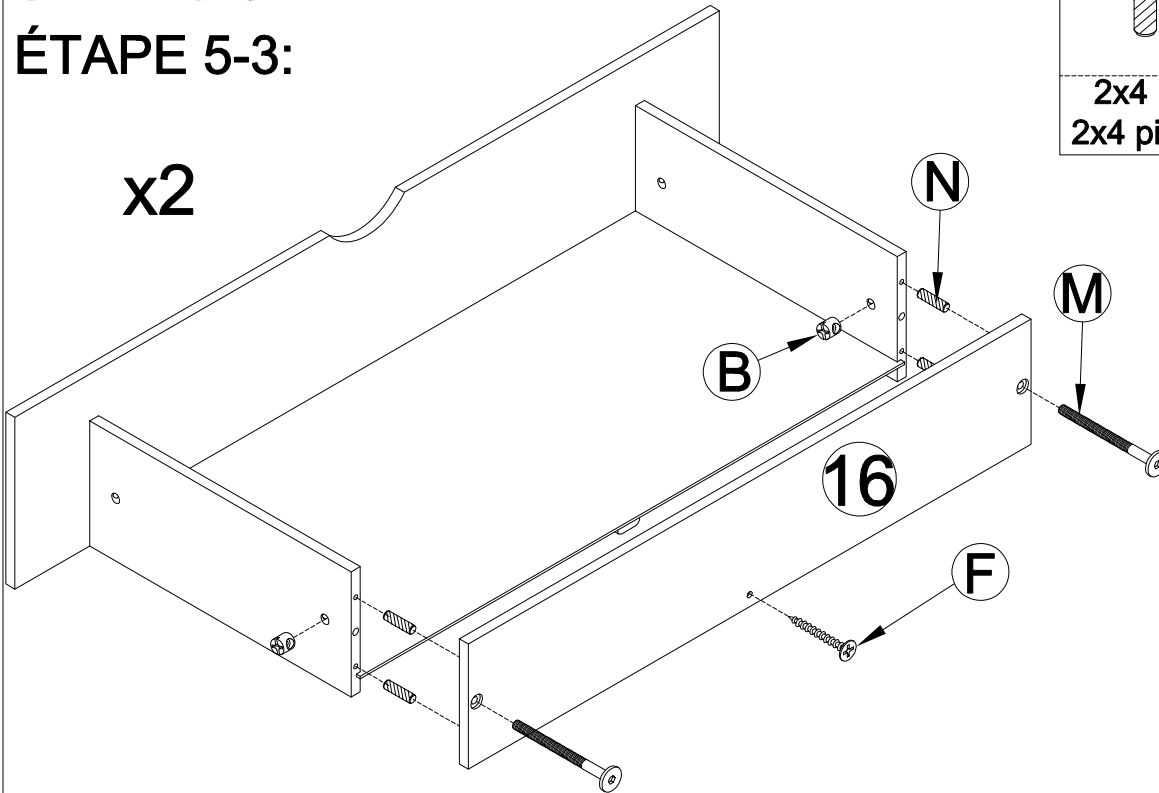

Push detail 19 in first and then push detail 18 into position
Poussez d'abord le détail 19, puis poussez le détail 18 en position.

STEP 5-3:
ÉTAPE 5-3:

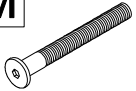

N 	M 
2x4 pcs 2x4 pièces	2x2 pcs 2x2 pièces
B 	F 
2x2 pcs 2x2 pièces	2x1 pcs 2x1 pièces

STEP 5-4:
ÉTAPE 5-4:

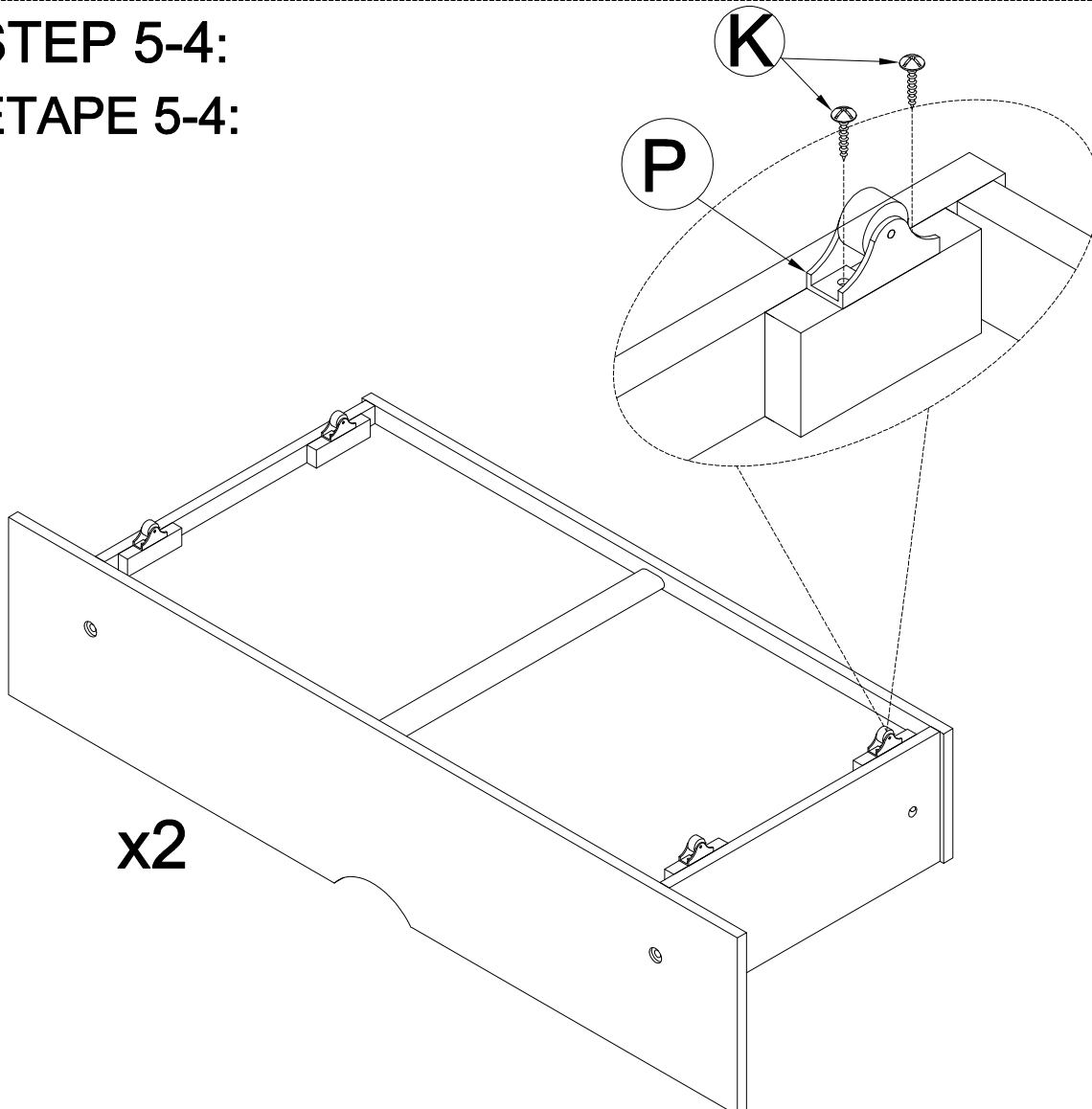

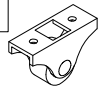
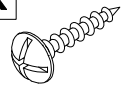
P 	K 
2x4 pcs 2x4 pièces	2x8 pcs 2x8 pièces

STEP 6: CONGRATULATION. YOU HAVE COMPLETED THE BED

Push 2 Drawers into position

ÉTAPE 6 : FÉLICITATION. VOUS AVEZ TERMINÉ LE LIT

Poussez les 2 tiroirs en position

