

ASSEMBLY INSTRUCTION

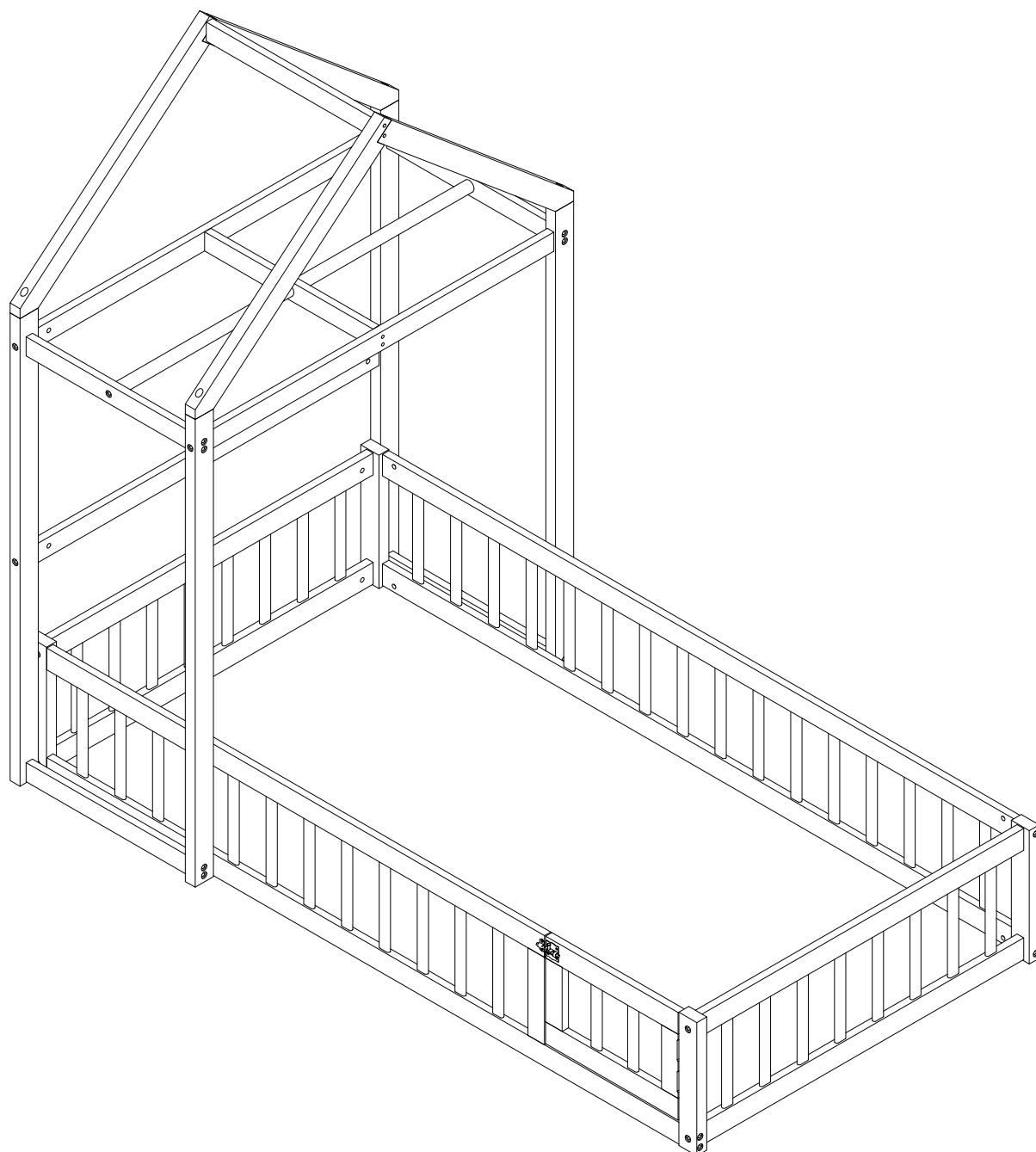







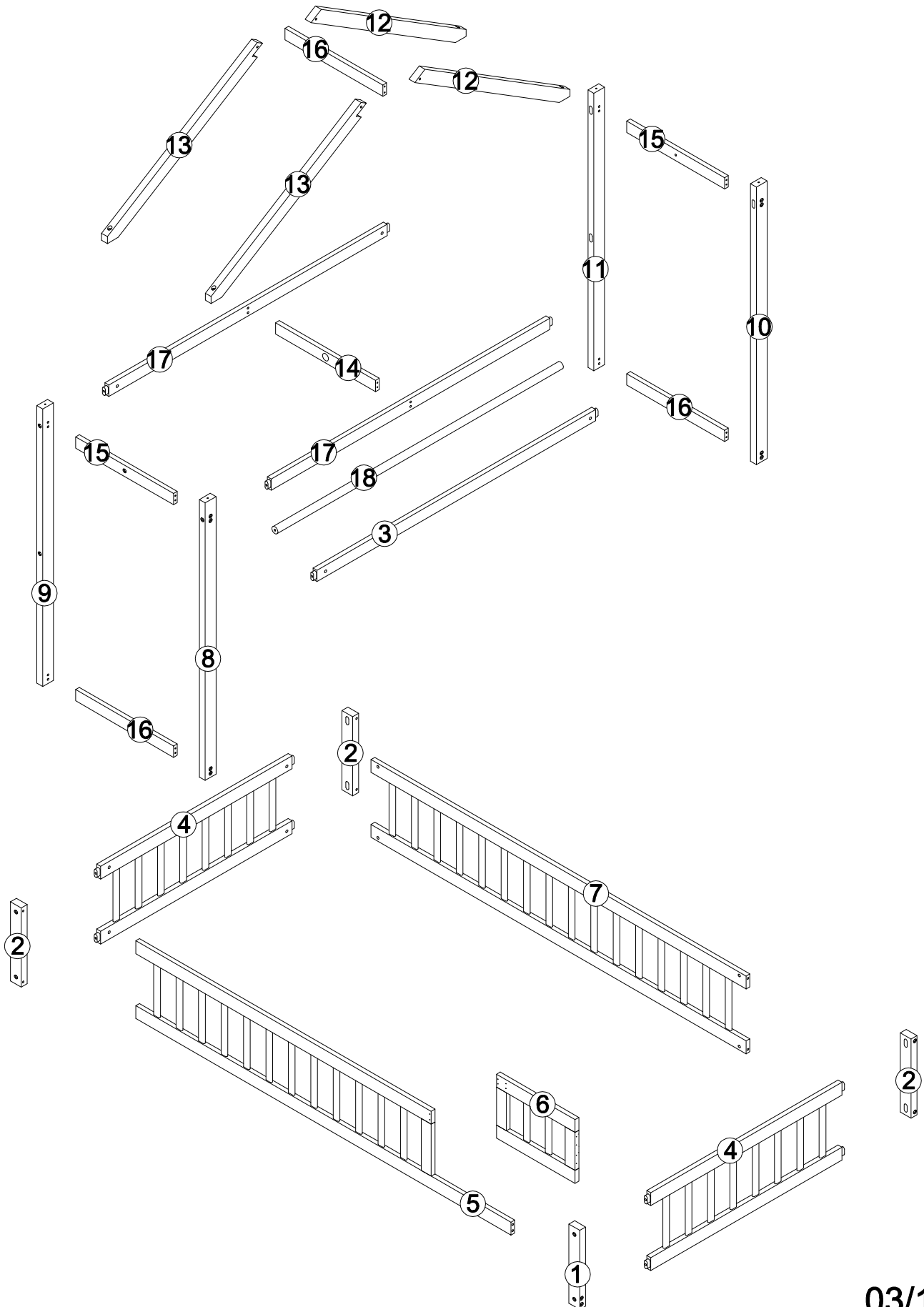

SAFETY WARNINGS AND GENERAL NOTES

- 1. Do not use substitute parts. Contact the manufacturer or dealer for replacement parts.**
- 2. Keep these instructions for future reference.**
- 3. We recommend assembling your bed on the shipping carton to protect your floor.**
- 4. Be certain all staples are out of the box before beginning assembly on the shipping carton.**
- 5. Replacement Parts:**
Replacement Parts, including additional guardrails, may be obtained from any of our dealers.

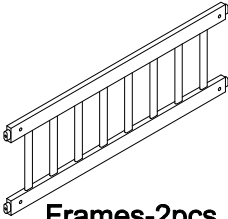
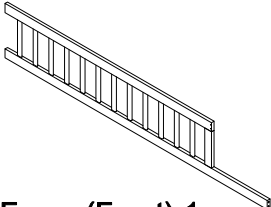
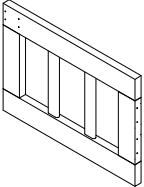
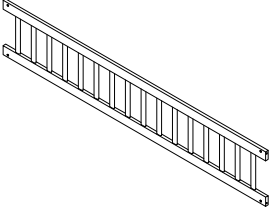

ASSEMBLY INSTRUCTION

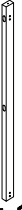

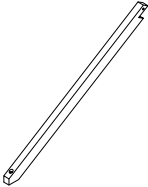
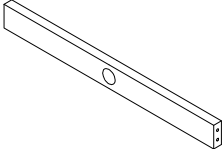
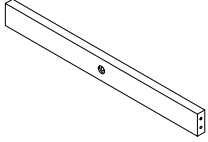
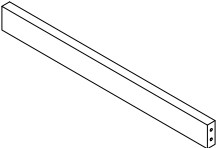
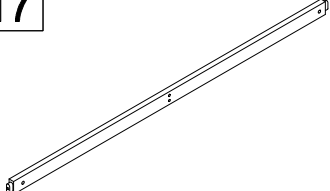
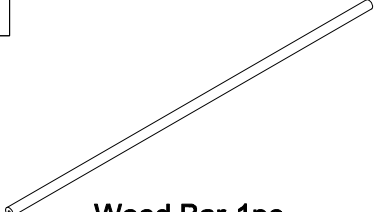
Part List (Box

<p>1</p>  <p>Leg-1pc</p>	<p>2</p>  <p>Legs-3pcs</p>	<p>3</p>  <p>Wood Bar-1pc</p>
<p>4</p>  <p>Frames-2pcs</p>	<p>5</p>  <p>Side Frame(Front)-1pc</p>	<p>6</p>  <p>Door Frame-1pc</p>
<p>7</p>  <p>Side Frame(Back)-1pc</p>	<p>8</p>  <p>Leg-1pc</p>	<p>9</p>  <p>Leg-1pc</p>
<p>10</p>  <p>Leg-1pc</p>	<p>11</p>  <p>Leg-1pc</p>	<p>12</p>  <p>Roof Top Bars-2pcs</p>
<p>13</p>  <p>Roof Top Bars-2pcs</p>	<p>14</p>  <p>Wood Bar-1pc</p>	<p>15</p>  <p>Wood Bars-2pcs</p>
<p>16</p>  <p>Wood Bars-3pcs</p>	<p>17</p>  <p>Wood Bars-2pcs</p>	<p>18</p>  <p>Wood Bar-1pc</p>

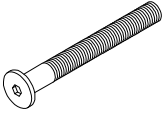
Hardware List (Box

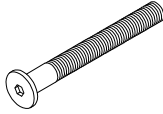
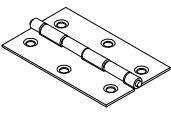
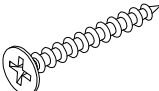
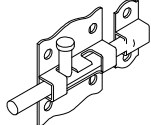
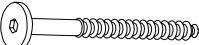
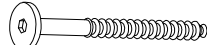
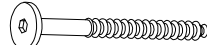
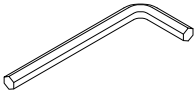
A  Ø1/4" x 70 mm Hex-Head bolts 8pcs	B  Ø1/4" x 13 mm Horizontal-Hole bolts 22pcs	C  Ø1/4" x 100 mm Hex-Head bolts 14pcs
D  Leaf hinge 2pcs	E  M3 x 12 mm Wood Screws 18pcs	F  Catch(20x38x38) 1pc
G  Screws 1/4"x60 20pcs	H  Screws 1/4"x50 6pcs	I  Screws 1/4"x70 4pcs
J  Allen Key 1pc		

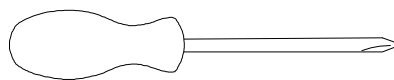

Assembly Tools Required (Not Included)

STEP 1: Following below illustration:

- Using HW #A,#B to connect ②&② Legs with ④ Frame
- Using HW #A,#B to connect ①&② Legs with ④ Frame

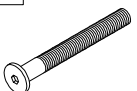
B		A	
8pcs		8pcs	

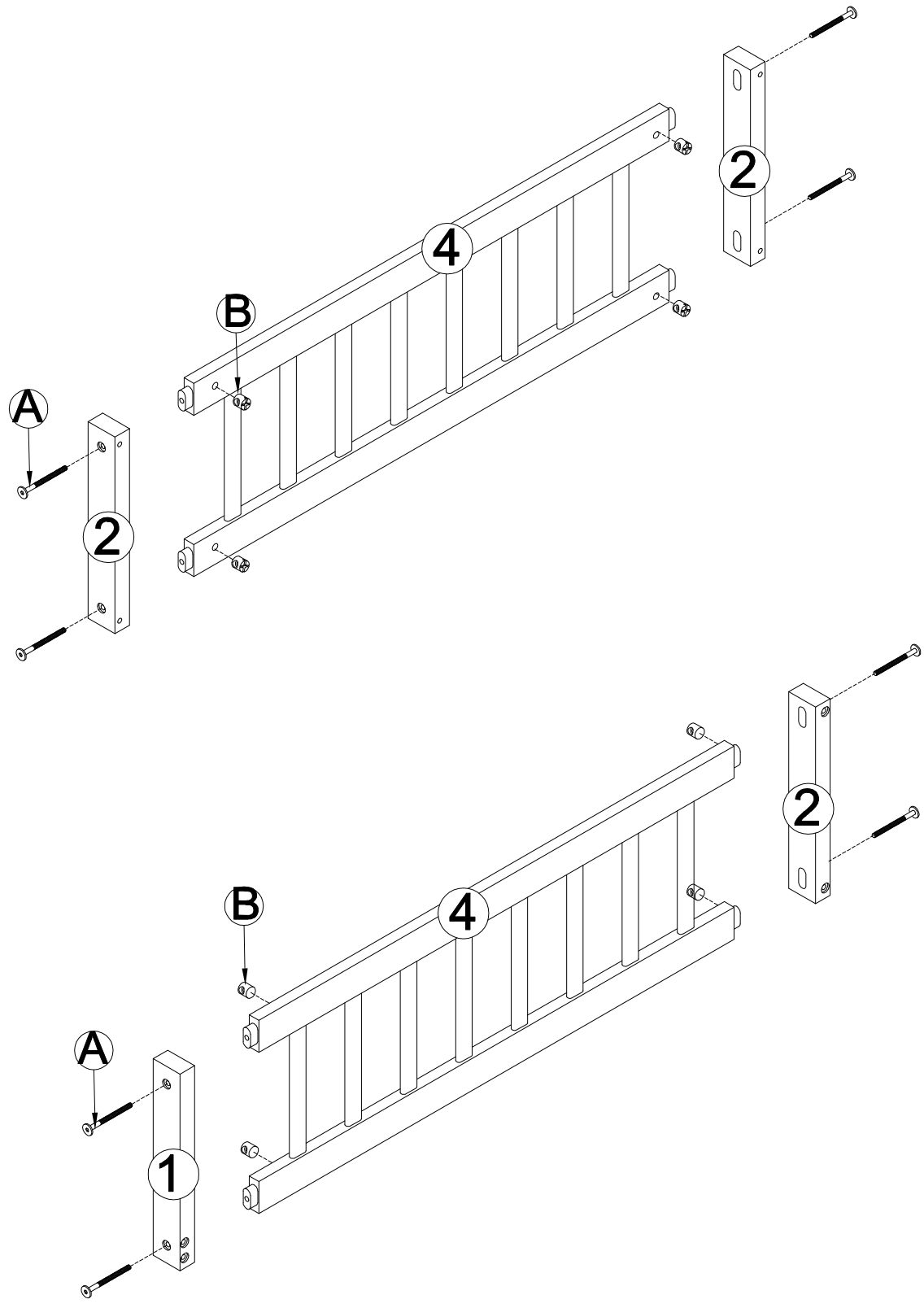

STEP 2: Following below illustration:

-Using HW #B,#C to contact ⑤ & ⑦ side rails with ④ frame(completed in Step1)

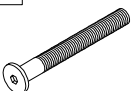
B		C	
8pcs		8pcs	

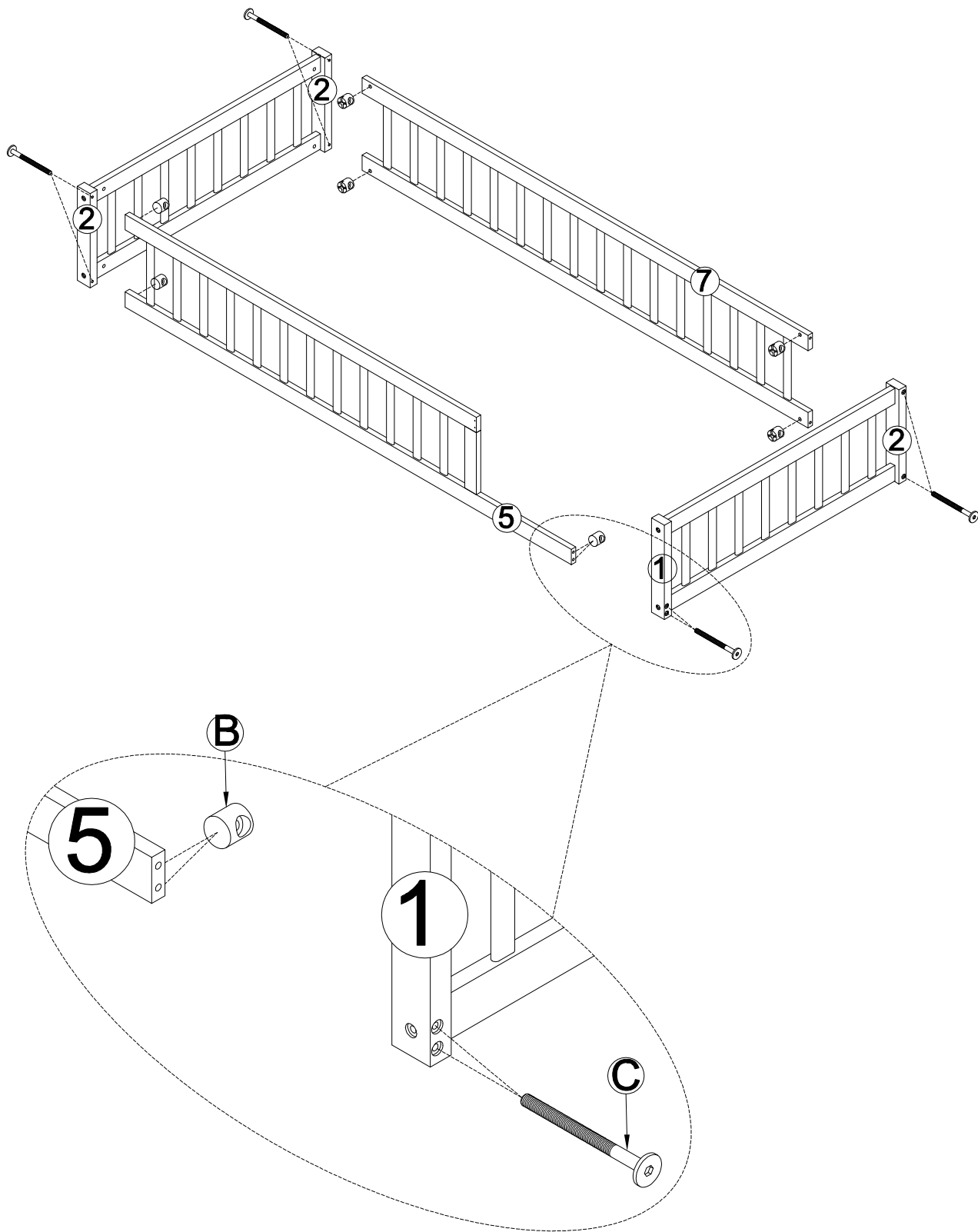

STEP 3: Following below illustration:

Do not drill positioning holes
Customers align and screw

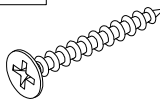
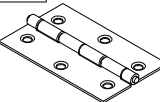
E	
	12pcs
D	
	2pcs

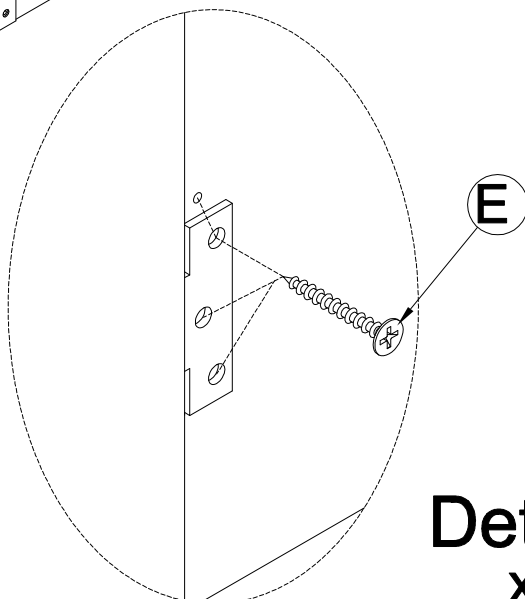
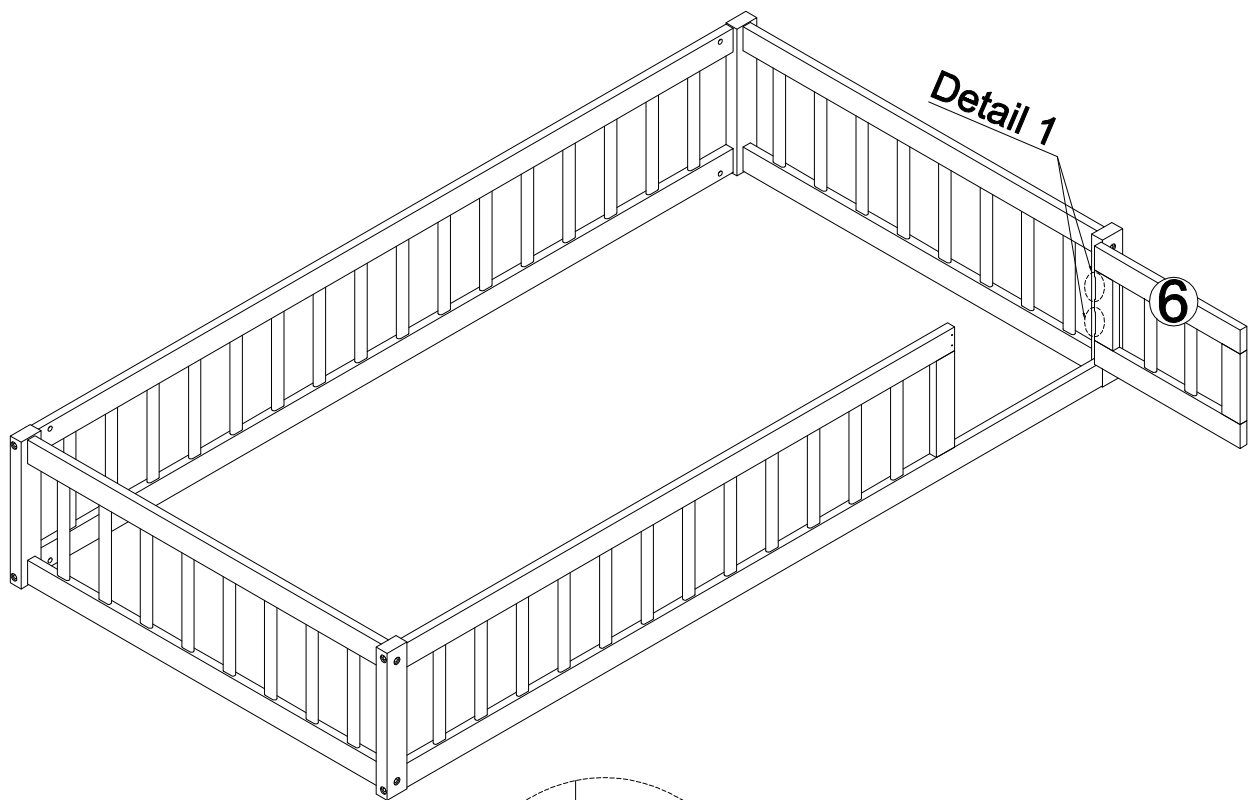
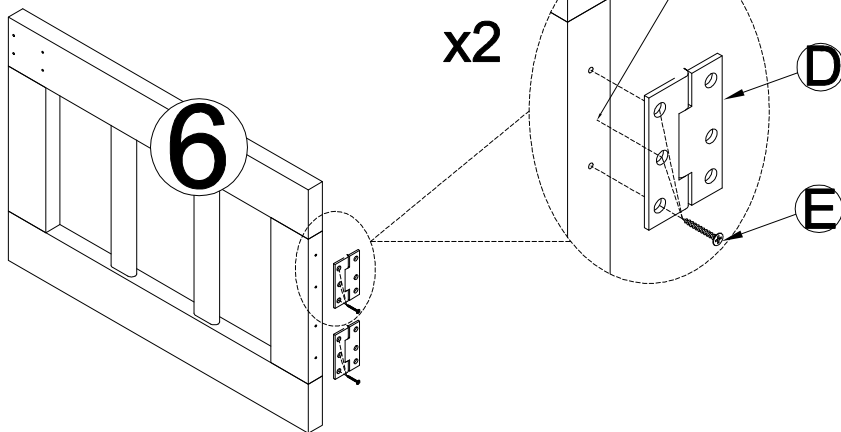

Detail 1
x2

STEP 4: Following below illustration:

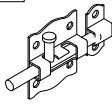
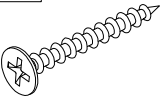
F 	E 
1pc	6pcs

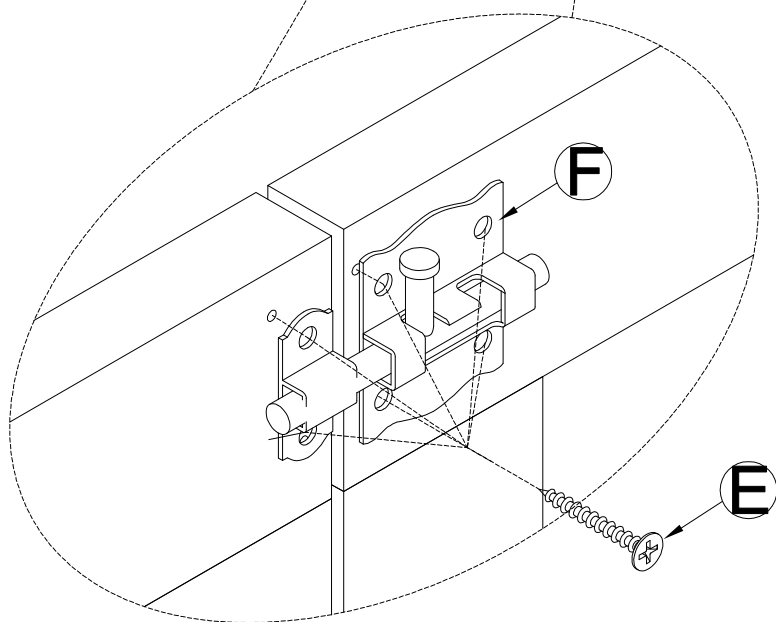
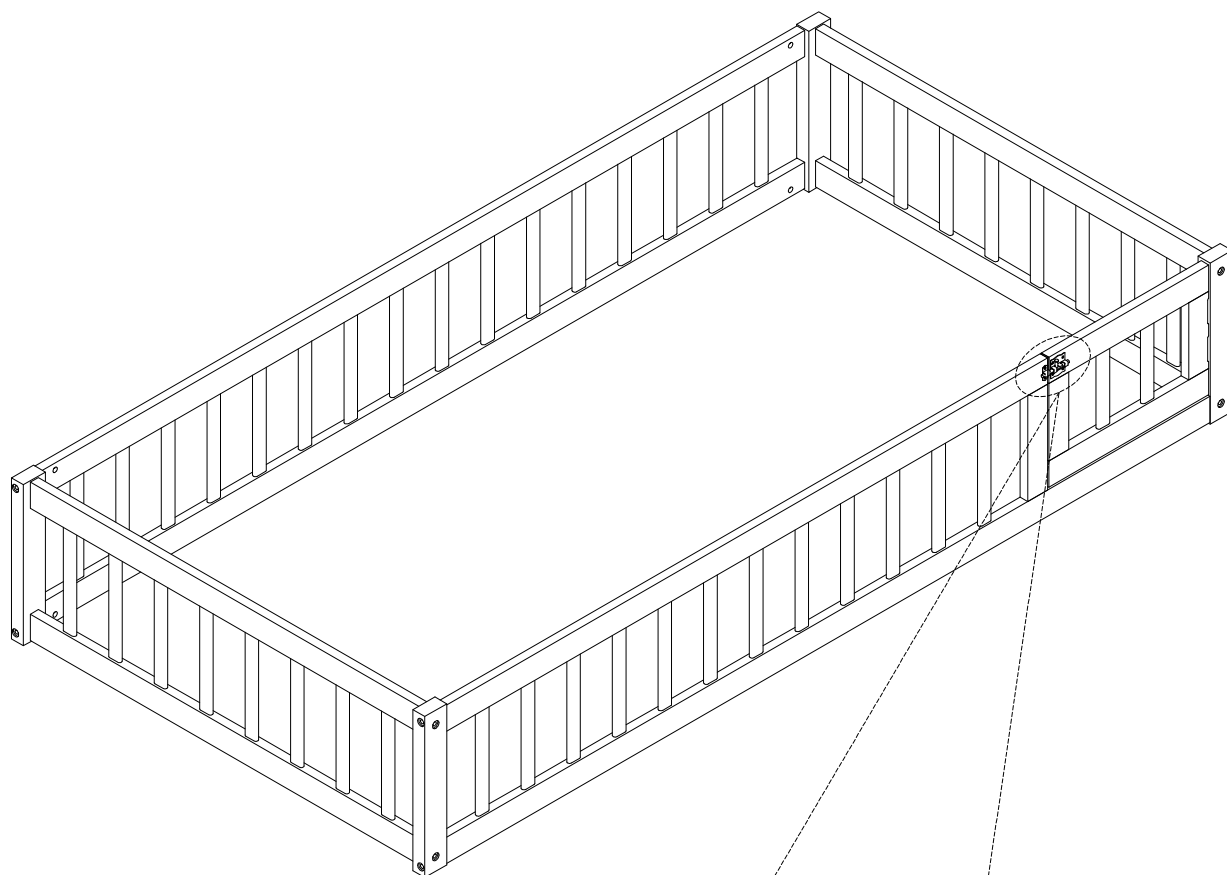

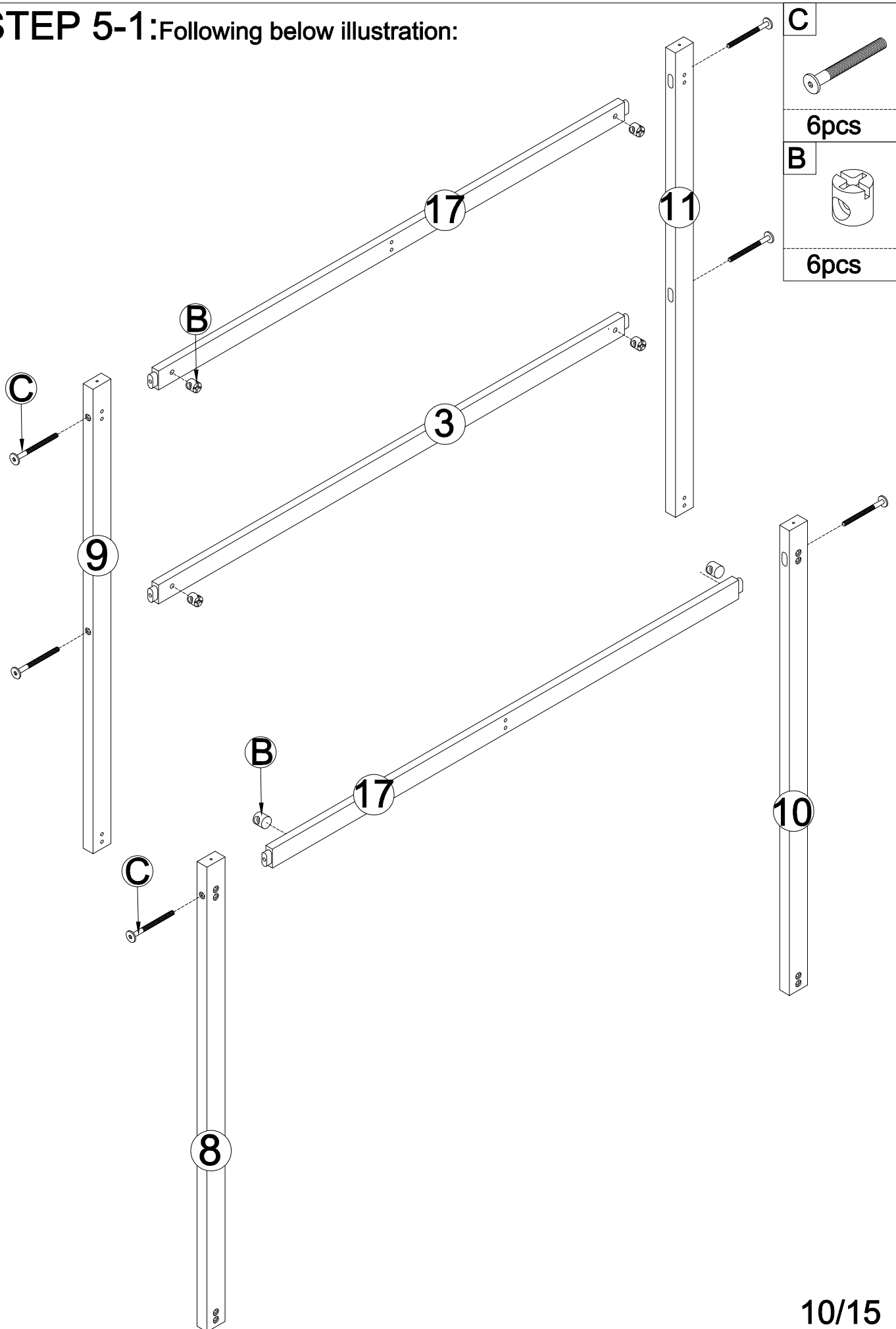

STEP 5-1: Following below illustration:

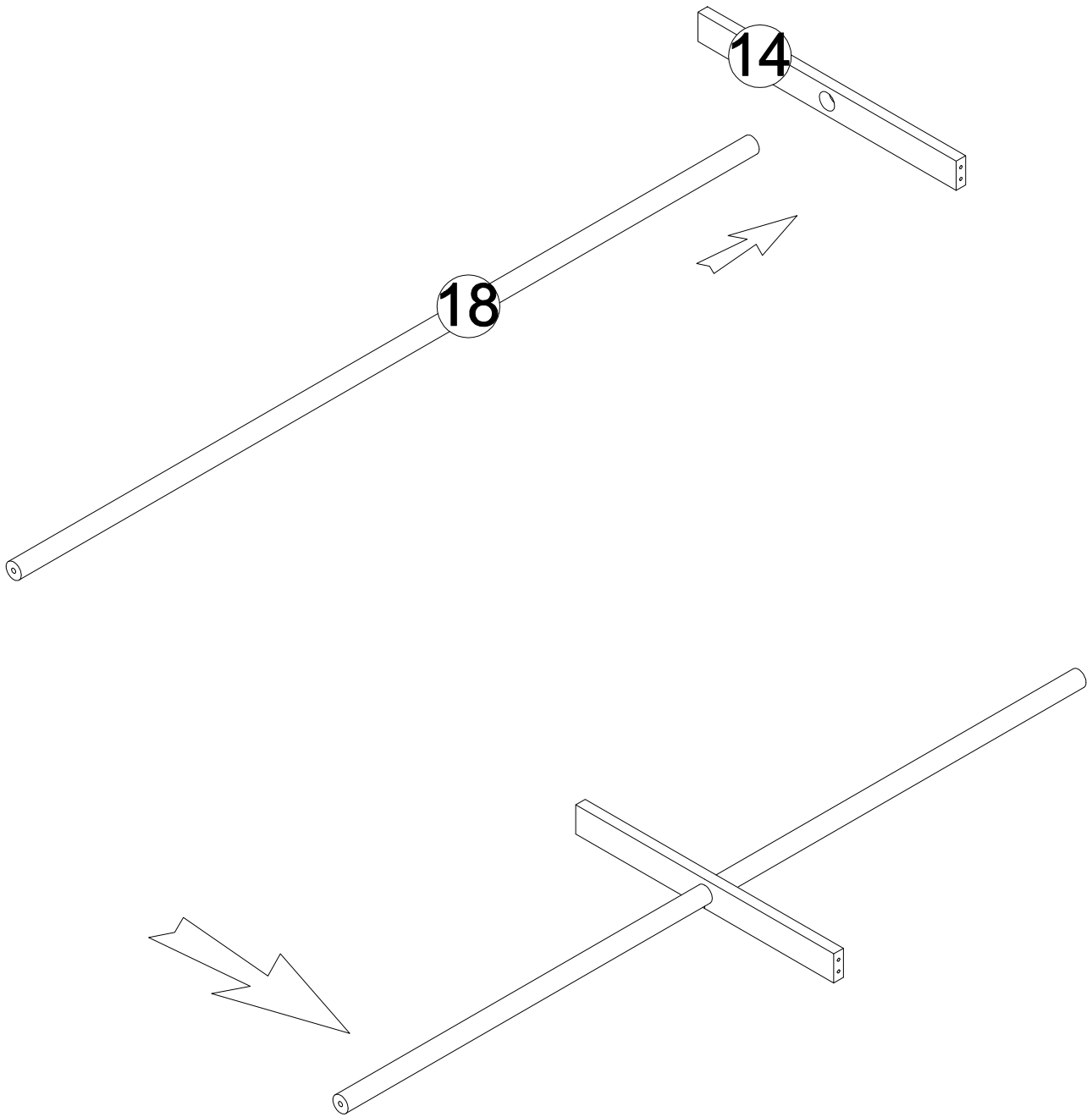

STEP 5-2:Following below illustration:



STEP 5-3: Following below illustration:

H	G
	
6pcs	16pcs

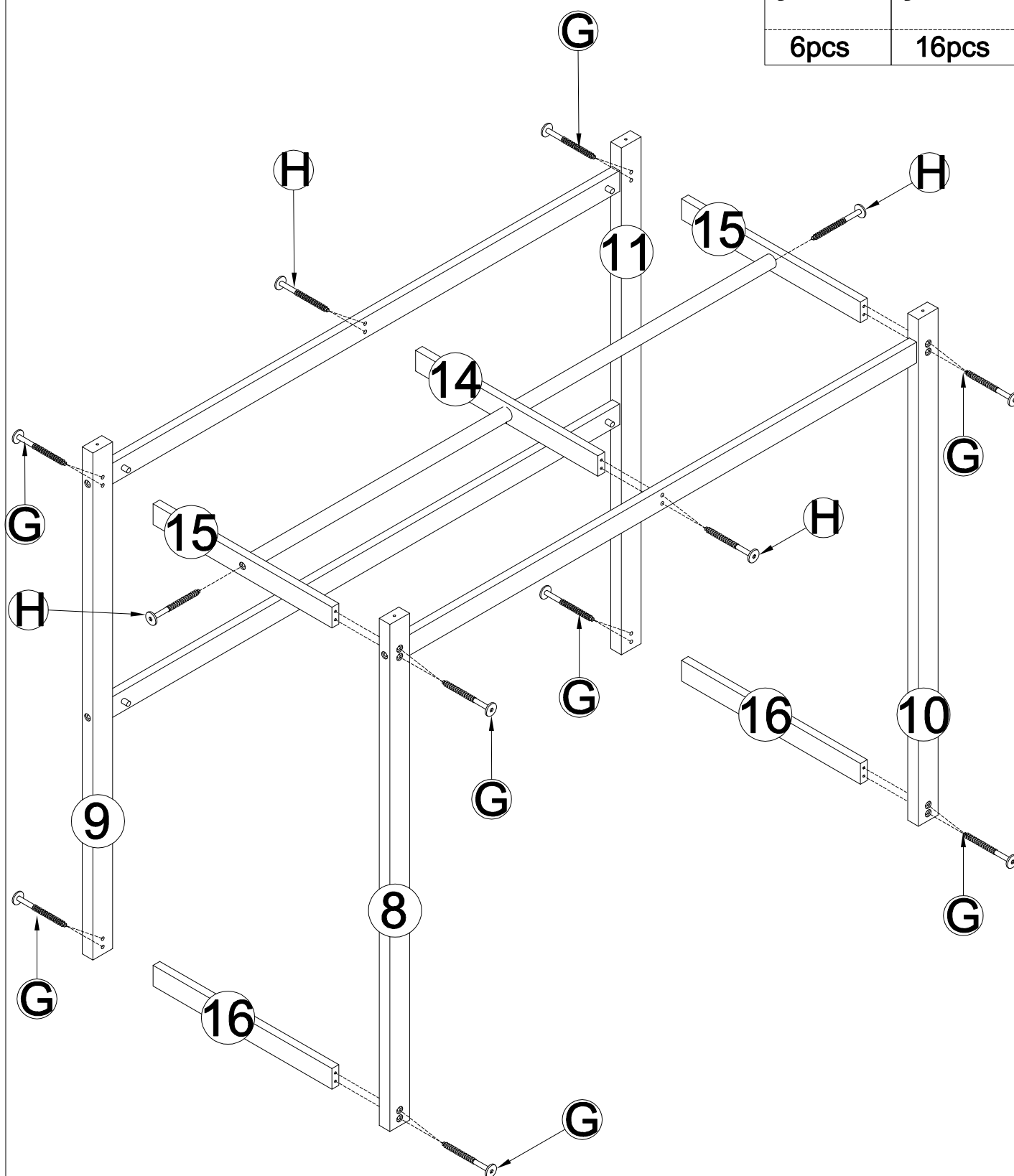

STEP 5-4:Following below illustration:

G

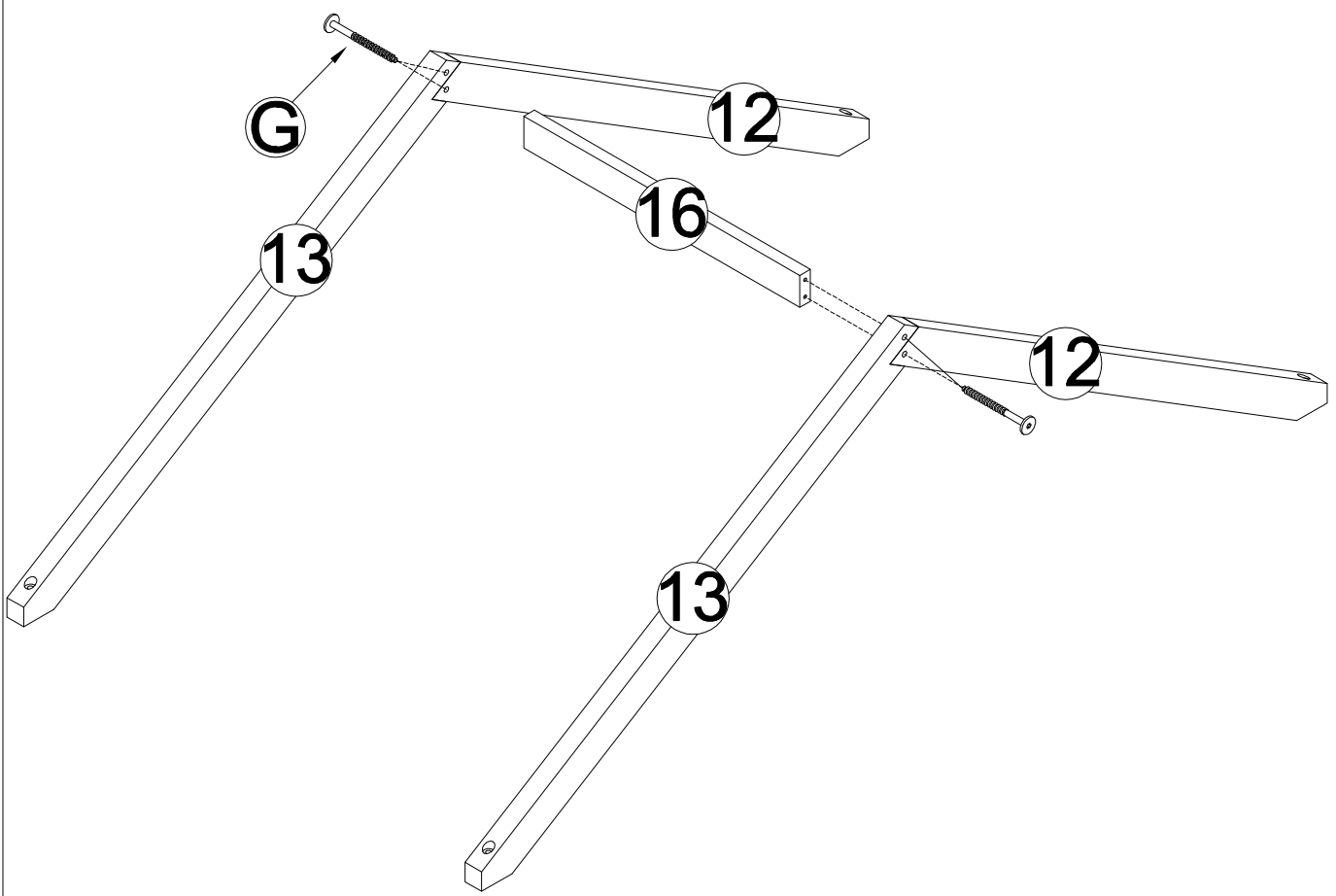
4pcs

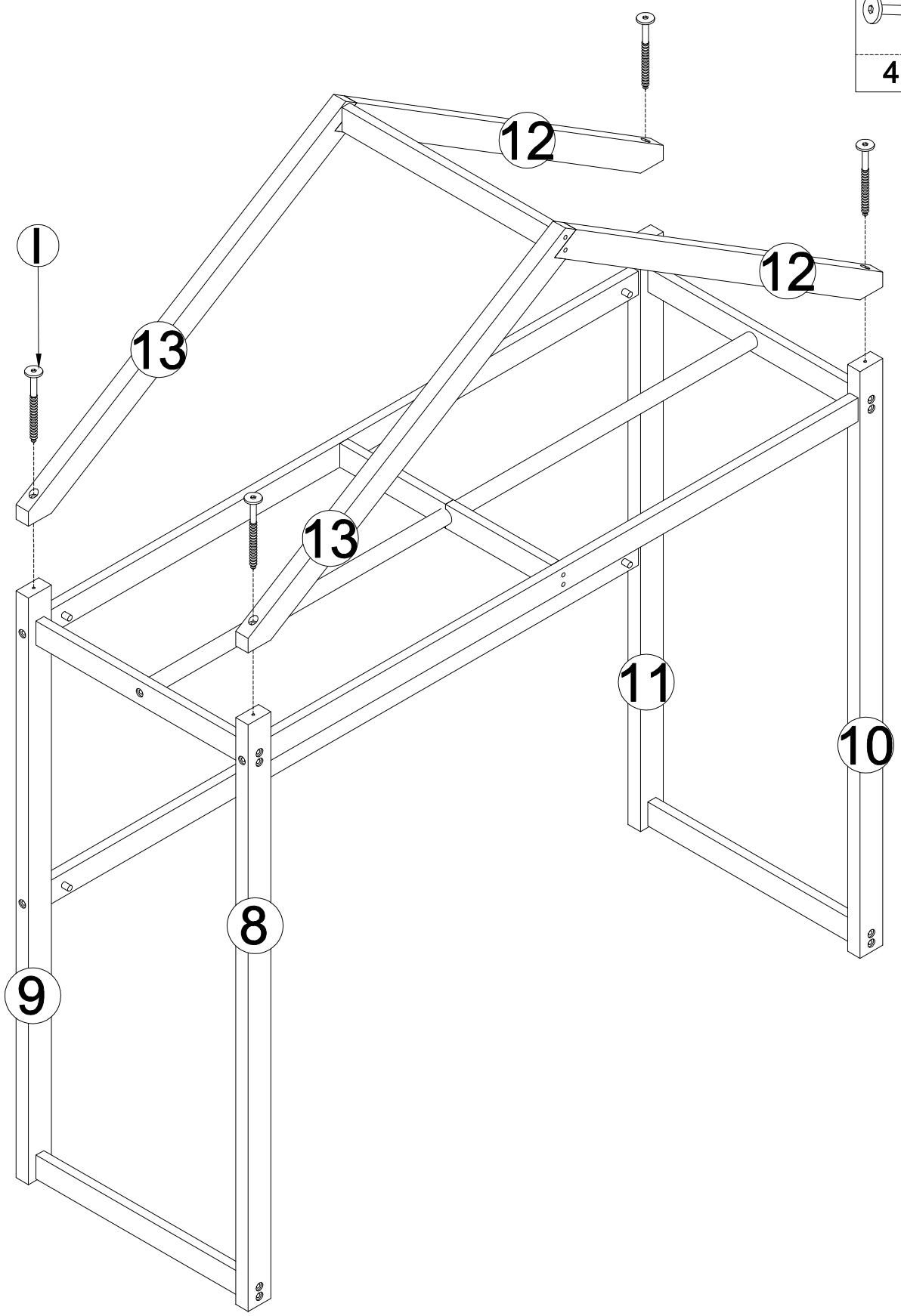

STEP 5-5: Following below illustration:

I

4pcs



STEP 6: CONGRATULATION. YOU HAVE COMPLETED THE BED
Push BED into position

