

ESHINE[®]

BY ESHINE SLEEP

POWER ADJUSTABLE BASE

OWNER'S MANUAL

Installation & Operation



Model: ETK-3000PSTK

Table of Contents

Safety & Warranty Warnings	01
Parts List	02
Installation Guide	03
ESHINE Remote Control Instructions	05
Setting Programmable Position and Pairing Remote	06
Special Function	07
Trouble Shooting	08

Safety & Warranty Warnings

READ THE FOLLOWING INFORMATION CAREFULLY BEFORE USING THIS PRODUCT

If unable to understand warnings, cautions, and/or instructions, contact the dealer or technical personnel if applicable, before attempting to use the equipment. Otherwise, injury or damage may result.

SAFETY WARNINGS:

- Do not use bed outdoors.
- Do not use bed near explosives.
- Using bed with oxygen administering equipment other than the nasal masked type creates a possible fire hazard.
- When using nasal or masked type administering equipment, route and secure oxygen or air tubing properly to ensure that tubing does not become entangled or damaged during normal operation of the bed.
- Use caution when having liquids in or around the bed to ensure no spilling occurs. In case of spillage, stand in a dry, clean area of the floor and unplug the bed immediately. Clean up spill and allow the area around bed to dry thoroughly before using the electric controls again. Do not eat or drink hot liquids while operating the bed.
- This appliance is not intended for use by persons (including children) with reduced physical, sensory or mental capabilities, or lack of experience and knowledge, unless they have been given supervision or instructions concerning use of the appliance by a person responsible for their safety.
- Do not allow children or individuals with disabilities to operate the bed without adult supervision.
- Do not allow any person or pet under the bed at any time.
- During bed operation, make sure body is positioned within the confines of the bed. Do not place extremities over the sides of the bed when operating bed functions.

DO NOT sit on the raised head section.

- Sitting on the raised parts can be dangerous and may cause damage to the bed. Please follow the correct usage instructions to ensure your safety and the proper functioning of the product.

RADIO FREQUENCY: 2.4 GHz

FCC COMPLIANCE:

This device complies with Part 15 of the FCC Rules. Operation is subject to the following two conditions: (1) This device may not cause harmful interference, and (2) this device must accept any interference received, including interference that may cause undesired operation.

To comply with the FCC RF exposure requirements, no change to the antenna or the device is permitted. Any change to the antenna or the device could result in the device exceeding the RF exposure requirement and void user's right to operate the device.

Product Rating:

The motors are not designed to operate continuously for more than [2] minutes in an [18] minute time period or approximately 10% duty cycle. Attempting to circumvent or exceed this rating will shorten the life expectancy of the foundation and may void the warranty.

Operating Information:

- After power foundation assembly is completed, operate remote control to ensure proper functions.
- Keep moving parts free of obstruction during bed operation (including sheets, clothing, tubing, wiring, and products using electric power cords).
- Distribute body weight evenly over bed surface. Do not place entire weight on head or foot sections of the bed, during repositioning and entering or exiting bed.

Hospital Use Disclaimer:

This power foundation is designed for residential use only. It is not approved for hospital use and does not comply with hospital standards.

Weight Limits:

This product is not rated to support weights in excess of 750 pounds inclusive of the mattress and bedding. The bed will structurally support this weight, provided it is evenly distributed across the foundation. The power foundation is not designed to support or lift this amount in the head or foot sections alone. Exceeding this weight restriction could damage the bed and/or cause injury and will void the warranty.

WARRANTY WARNINGS:

Do not open or tamper with control box, motors, or remote (with the exception of battery compartments). The warranty will be void if the internal workings of these components are tampered with.

WARNING

DO NOT USE THIS BED IF WEIGHT
LIMITATION IS EXCEEDED.

Parts List

All electronics and components that need to be installed are located in boxes under the foundation or attached to the frame. Before discarding the packing materials, ensure that all the parts are accounted for.

A.



AA Batteries (2)

B.

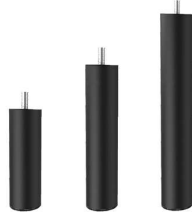

Adjustable Legs

C.



Power Supply (1)

D.



Power Cord (1)

E.



Remote Control (1)

F.

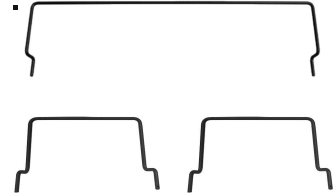

Retainer Bar (3)
Attached to the bed frame

ESHINE ADJUSTABLE POWER BASE ELECTRONICS QUICK REFERENCE GUIDE

ESHINE WIRELESS OVERVIEW

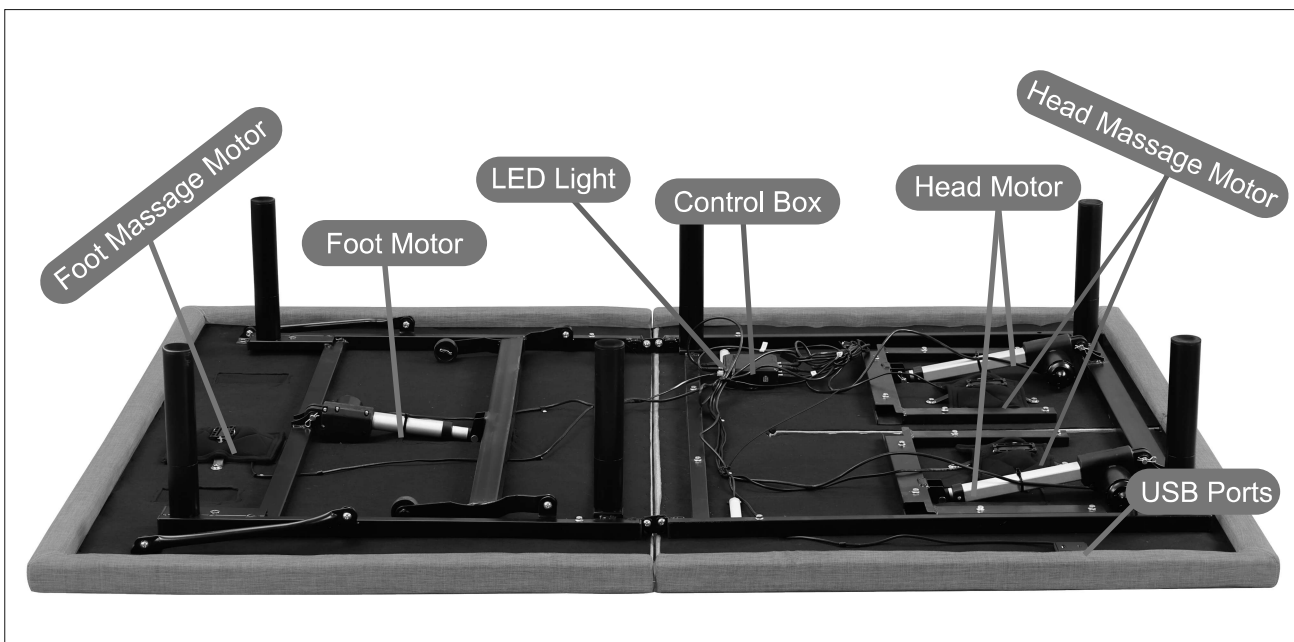

Installation Guide

OPEN THE PACKAGE

For safety reasons, lifting of the adjustable bed frame must be performed by two (2) people; and the unit should always be in flat position before opening

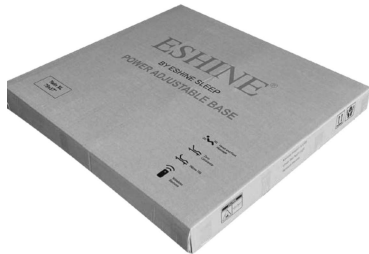

Lift the folded bed frame unit out of the shipping carton carefully, and then put it on a Flat floor.

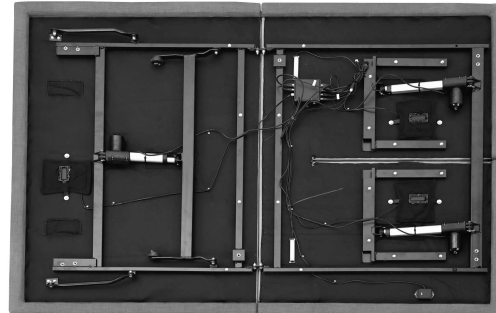

Lower the head and foot frame pieces with their top side facing downward.

ATTACHING THE BED LEGS

Remove the six (6) bed legs from the accessory box. Hand tighten the legs by threading them clockwise into the pre-threaded holes on the bed frame.



Attention: install the bed legs after the bed frame is laid flat/ leveled.

INSTALLING THE RETAINER BAR

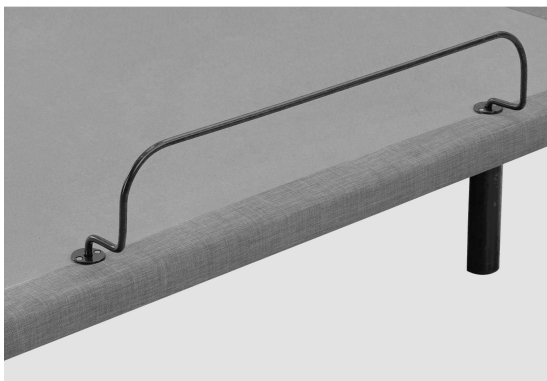

STEP 1

Turn the bed frame over carefully, top side up.

STEP 2

Insert the ends of the retainer bar into the quick connect brackets located at the foot of the bed.

Installation Guide

SETTLING UP THE ELECTRONICS



STEP 1

Take out the power supply and the power cord from the accessory box.

STEP 2

Connect the power supply lead from the control box to the power supply.



STEP 3

Connect the power cord that was packaged with the power supply to the power supply.



STEP 4

Plug the power cord into a working electrical outlet. The LED lights under the base will flash for 10 seconds.



STEP 5

Install the two (2) AAA batteries into the remote control.

STEP 6

Confirm the remote control works by pressing the lift buttons. Installation for single or independent operation of the bed frame is now complete.

ESHINE Remote Control Instructions

ESHINE WIRELESS REMOTE



ADJUST



The **Left HEAD** up and down



The **Right HEAD** up and down



The **FOOT** up and down

ONE TOUCH BUTTONS



One touch **ZG** preset position.



One touch **FLAT** preset position.



One touch programmable preset position.



One touch under bed LED light on/off.



One touch anti-snore preset position.



One touch press to lock/Hold 5 seconds to unlock.

MESSAGE FEATURE



The button will turn on the head massage.



The button will turn on the foot massage.



The button will let you choose between the 3 massage settings.



Massage ON/OFF

Setting Programmable Positions and Pairing Remote

SETTING PROGRAMMABLE POSITIONS

The wireless power bed has a programmable feature that allows you to save custom positions. Please read all the instructions below before setting your custom presets on the remote.

STEP 1

Adjust the head and foot to your desired position.



STEP 2

Press and hold the flat button **FLAT** first. Next, Choose your favorite sleep position. Then press and hold memory button **M** for 5 seconds until the buttons' lights are flashing. The position is then saved.

STEP 3

To adjust the saved position, repeat steps 1 and 2 and the new position will be saved.

REMOTE CONTROL PAIRING INSTRUCTIONS

Please follow the steps below to successfully pair your remote control with the bed:

STEP 1

Ensure the remote control is functioning properly.

Check the batteries and confirm the remote turns on.

STEP 2

Disconnect and reconnect the power supply.

Unplug the extension cord or power cable from the back of the power supply box. Wait for a few seconds, then plug it back in.



STEP 3

Enter pairing mode.

While reconnecting the power, simultaneously press and hold the following three buttons:

- Foot Up on the remote
 - Left Head Up on the remote
 - PAIR/Flat button
- (blue button, see image for reference)

STEP 4

Listen for a confirmation sound.

If pairing is successful, you will hear a single "beep" from the bed. The remote is now paired and ready to use.



Must Press The Pair Button & 2 Adjustment Buttons Simultaneously



Special Function

EMERGENCY POWER DOWN

Your adjustable bed frame comes with a power supply that supports the emergency power-down feature when powered by two new 9V batteries.

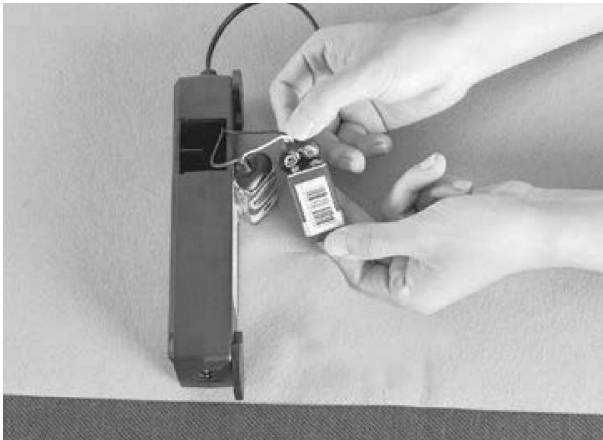

STEP 1

Install two (2) new 9V batteries in the battery compartment of the power supply.

STEP 2

Press the flat position on the remote if there is no power from the electrical outlet.

STEP 3

Replace the two (2) 9V batteries after this procedure. The 9V batteries (not included in the box) are for single use only.

SPLIT HEAD ADJUSTMENT FEATURE



The head of this bed frame is equipped with two motors, enabling separate adjustment. This allows users to choose a comfortable angle according to their personal preferences without affecting the other person.

The foot of the bed frame has one motor, and it functions as an integrated unit.



The head can synchronize in one position

Troubleshooting Self-Check

Steps	Check Contents	Normal Situation	Abnormal Situation and Treatment
1# Remote Control	After installing the batteries, press the remote control to see if the light is on	The light is on.	If the light is off, contact us for a replacement of remote control.
2# Pairing	1: Please ensure the battery is installed correctly. Does the remote control light up when you press a button? 2: Please check if the power supply and control box light up green when the power is plugged in.	If the remote, power supply, and control box are all light up. It is possible that the remote control has failed to connect with the bed frame.	If pairing fails, press 'Foot Up' and 'Left Head Up' buttons at the same time for 5 seconds. Then press the 'Pair' button power on the supply cord. If the remote pairs with the bed successfully, you will hear a beep sound from the bed. If it still fails to pair, reach us for a replacement of remote control.
3# Function Button Rest	If the Anti-Snore / ZG button does not work	ZG: Head up 15°, Foot up 35° Anti Snore: Head up 10°, Foot up 0°	The angles of all function buttons can be reset. We will use the 'ZG' button reset as an example." Steps to Set Up 'ZG': 1: The default angle for 'ZG' is 15 degrees for the head and 35 degrees for the feet. However, you can adjust it to your preferred position. 2: Adjust the bed to your desired angle. Press and hold the 'ZG' button without moving for about five seconds. 3: If the setting is successful, you will hear a beep sound from the bed. Other function buttons can be set in the same way. If you have any questions, feel free to contact our customer service.
4# Power Supply & Control Box	Plug in the power supply to see if the green lights of the power supply and the control box are on (see Figure1, Figure2)	The lights are on.	If not on, let us know which one is off and contact us for corresponding replacements.

Figure1: Control Box;

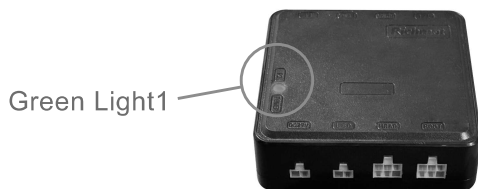

Figure2: Power Supply;



Troubleshooting

Troubleshooting Self-Check

Steps	Check Contents	Normal Situation	Abnormal Situation and Treatment
5# Emergency Power Down		The bed can be flattened using the remote control.	When you meet the power outage and the bed is stuck in a position that you dislike. Follow the steps below to flatten the bed, Firstly, put 2 pcs 9V batteries in the Power supply. Then press the 'Flat' button on the remote.

Figure3: Emergency Power Down;



Left Head Motor

Right Head Motor



Put the battery in the power supply

ESHINE[®]

BY ESHINE SLEEP

POWER ADJUSTABLE BASE

If you have had any issues with the assembly process, you can contact our Customer sales2@eshinesleep.com

Official Website:
<http://www.eshinesleep.com/>
 Contact customer service at +1 (909) 721-9300

-THANK YOU FOR PURCHASING-

ESHINE[®]

BY ESHINE SLEEP

POWER ADJUSTABLE BASE