

# Dining Chair

## INSTRUCTION MANUAL

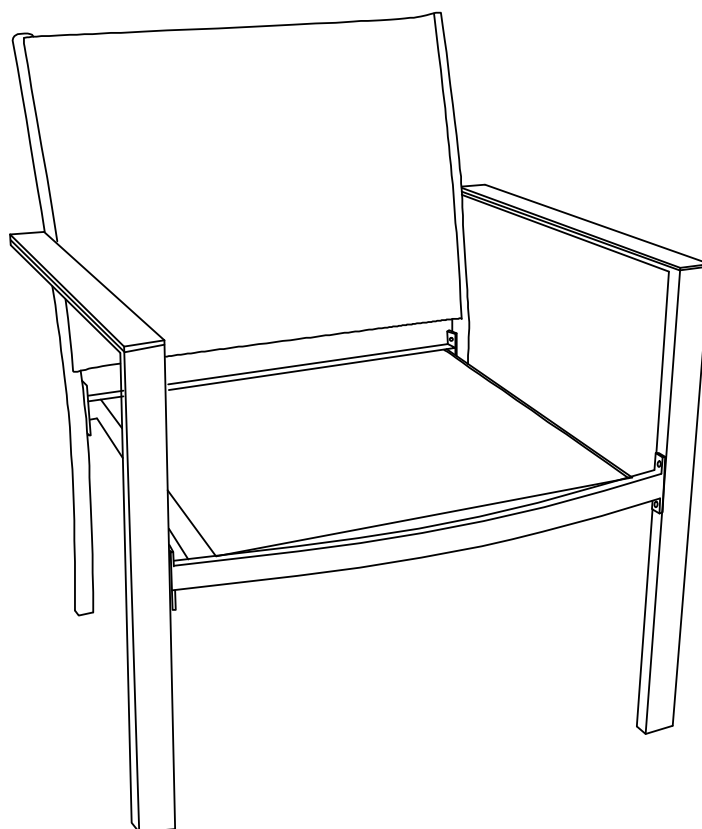

### **IMPORTANT: READ THIS INSTRUCTION CAREFULLY BEFORE PROCEEDING.**

This manual will provide you with clear and detailed instructions on how to safely and correctly assemble and maintain your Dining Chair, to ensure it brings you enjoyment.

### **FOLLOW US ON**

 @abbapatio







 @abbapatio

 @Abba\_Patio

 @abbapatio\_official

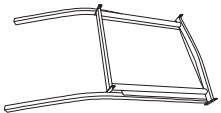
# PARTS LIST





Make sure all parts listed below have been included in your package.

REF	PART NAME	QTY (PER UNIT)	QTY (PER BOX)
<b>A</b>	 Left Armrest	1	2
<b>B</b>	 Right Armrest	1	2
<b>C</b>	 Backrest & Seat	1	2
<b>D</b>	 Screw	8	16+2
<b>E</b>	 Washer	8	16+2
<b>F</b>	 Hex Key	1	1

# ASSEMBLY

**Tip:** Position screws initially during assembly and secure them tightly after all components are assembled.



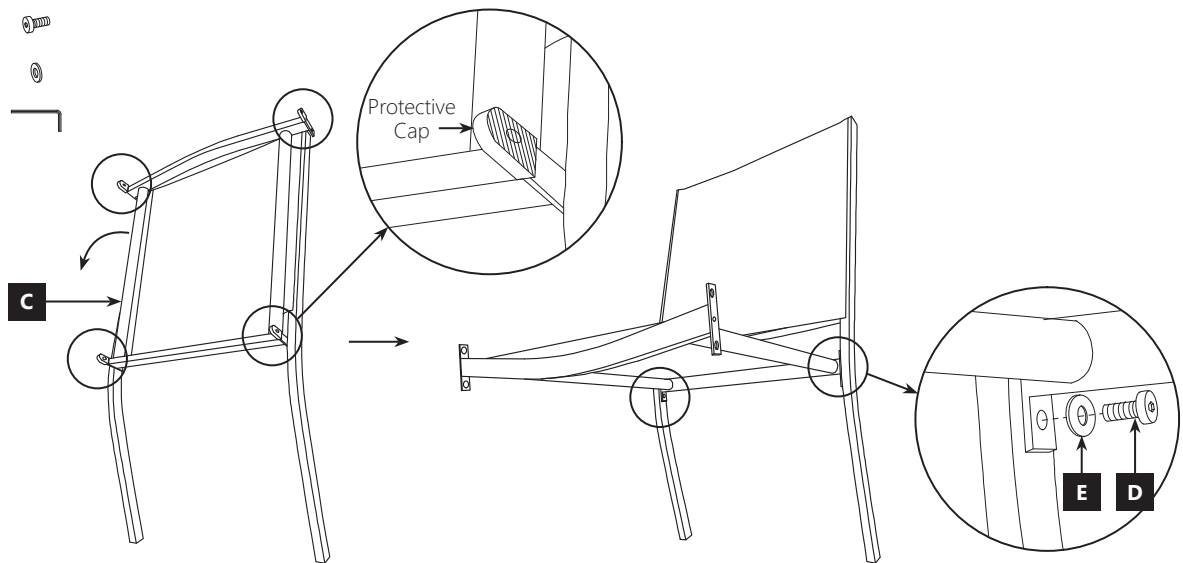

## 1. Unfolding the Backrest & Seat

- C** x1 
- D** x2 
- E** x2 
- F** x1 



**1A)** Remove all 4 protective caps. Unfolding the backrest & seat **C** and assemble with the screw **D** and washer **E**. Using hex key **F**.  
**Warning:** Please keep protective caps in a place out of reach of children to prevent accidental ingestion.

## 2. Armrest assembly

- A** x1     **E** x6   
**B** x1     **F** x1   
**D** x6 

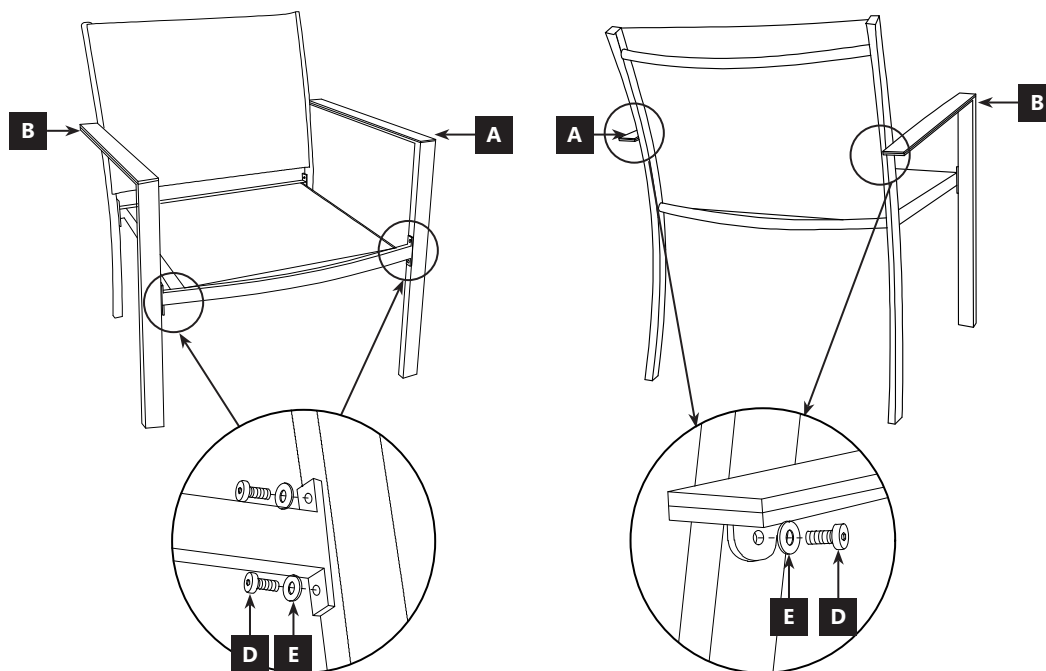

**2A)** Connect the left armrest **A** and right armrest **B** to the seat with the screw **D** and washer **E**. Using hex key **F**.

**2B)** Secure the left armrest **A** and right armrest **B** to the backrest by tightening the screw **D** and washer **E**. Tighten all the screws. Using hex key **F**.

# IMPORTANT INFORMATION

**IMPORTANT! Read this information before proceeding.**

### WARNING:

When using the dining chair products outdoors, basic safety precautions should be followed to reduce unnecessary hazards, including the following:

- Adult assembly required.
- Choking hazard to children under the age of 3 years-contains small parts prior to assembly.
- Do be careful that some parts are heavy and sharp.
- Do not place the dining chair in environments with flammable or caustic chemicals.
- Work well away from power lines, particularly when handling metal parts.
- Do not stand on the chair, nor adopt unsafe sitting positions on it.
- When the product is evenly loaded, the dining chair holds up to 496 lbs (225 kg).
- Do not place items beyond the edge of the product, and prevent items from falling.
- Do not allow children to climb on or play on the product to avoid serious bodily injury caused by the falling.
- Keep children and pets away from the assembly area until the work is completed.
- Before each use, inspect the dining chair for any signs of damage. Do not use if any parts are damaged, and replace worn or broken parts immediately.
- Never continue to use a product that is structurally unsound.
- Do not touch moving parts during operation.
- Keep clothing and body parts away from the dining chair to prevent them from getting caught in the moving parts
- Outdoor furniture is not made to bear low temperature conditions, which are likely to alter its correct operating and its surface condition.
- Please recycle packaging where possible.

# CARE & MAINTENANCE

- The dining chair is guaranteed to be free from any manufacturing defects for a period of 1 year from the date of purchase under normal use and in compliance with the open rating instructions.
- The warranty is valid only in the original country of purchase. Abba Patio® reserves the right to exchange an item for a replacement part. Some parts may be replaced with newer purchase model parts as the product is improved over time.

## FRAME:

- Dust and dirt will collect on the dining chair and will require periodic cleaning.
- Be sure to drain any water accumulated inside the frames. Air dry or wipe with a soft clean cloth.
- Clean surfaces with a dry or damp soft cloth. Do not use abrasive cleaners.
- Protect furniture with anti-rust spray and use regularly.
- When not in use, please store the furniture in a dry place and avoid direct sunlight to prevent material aging and deformation.
- If rust appears, it can be removed with a common product such as white vinegar or citric acid, or a cloth soaked in car polish can also help you remove rust.
- Only Abba Patio® replacement parts should be used. It may be unsafe to use parts supplied by another manufacturer.

## FABRIC:

1. Brush off loose dirt with a soft bristle brush.
2. Hose down.
3. Prepare a cleaning solution of water and mild.
4. Use a soft bristle brush to clean.
5. Allow cleaning solution to soak into the fabric.
6. A thorough rinse until all soap residue is removed.
7. Air dry.

## CLEANING METHODS FOR DIFFERENT STAINS:

### Oil-based spills.

1. Apply an absorbent such as corn starch, then remove with a straight edge.
2. Spray on mild cleaning solution of soap and water.
3. Rinse the fabric thoroughly to remove all soap residue.
4. Air dry.

### Mildew.

1. Prepare a solution of 1 cup and 1/4 cup mild soap per gallon of water.
2. Spray on entire area and allow to soak into the fabric for 15 minutes.
3. Clean entire surface area with a sponge, clean towel or very soft bristle brush.
4. Rinse thoroughly to remove all soap residue.
5. Air dry.

# CONTACT US FOR HELP

**Customer Service:** [customer@abbapatio.com](mailto:customer@abbapatio.com)

**Need Assistance? Call** +1 (888) 899-5617

## Hours of Operation:

**Phone Support:** Monday - Friday: 6:30 am - 4:30 pm, Saturday – Sunday: 8:30 am – 4:30 pm, PST.

**Email Support:** We are available 24 hours a day. Please allow up to 24 hours for a response.

**Note:** Our team is available to assist you during these hours. If you have any inquiries or require support outside of these hours, please leave a voicemail, send an email. We will get back to you promptly during the next available support hours. We thank you for your purchase!