



















CARE AND MAINTENANCE

Wipe clean with a soft, dry cloth. Test the cleaning method on a hidden area before using them over the entire area.

NOTICE

- * Please make sure that you have all parts indicated before you begin assembly of this item.
- * This item should be assembled on a soft surface to prevent scratching the finished product during assembly.
- * This item may require periodic tightening.
- * Do not tighten bolts until completely assembled.

Part List and Hardware List

PIECE	DESCRIPTION	PICTURE	QUANTITY
A	HEADBOARD		1X
B	L-POST		1X
C	R-POST		1X
D	FOOTBOARD		1X
E	SUPPORT LEGS OF SLATS		8X
F	SUPPORT LEGS OF RAILS		2X
G	SLAT		4X
H	L-RAIL		2X
I	R-RAIL		2X
J	WOOD LEG		2X
K	WOOD BAR		2X
H1	BOLT 5/16"*2-1/2"		10X
H2	BOLT 5/16"*2"		10X
H3	ALLEN KEY 5mm		1X
H4	SCREW Ø8*30mm		8X
H5	SCREW Ø8*15mm		8X
H6	BOLT 5/16"*3"		2X
H7	METAL PLATE 50*33*3mm		2X

Product Dimensions: 87.5"W*64"Dx55"H

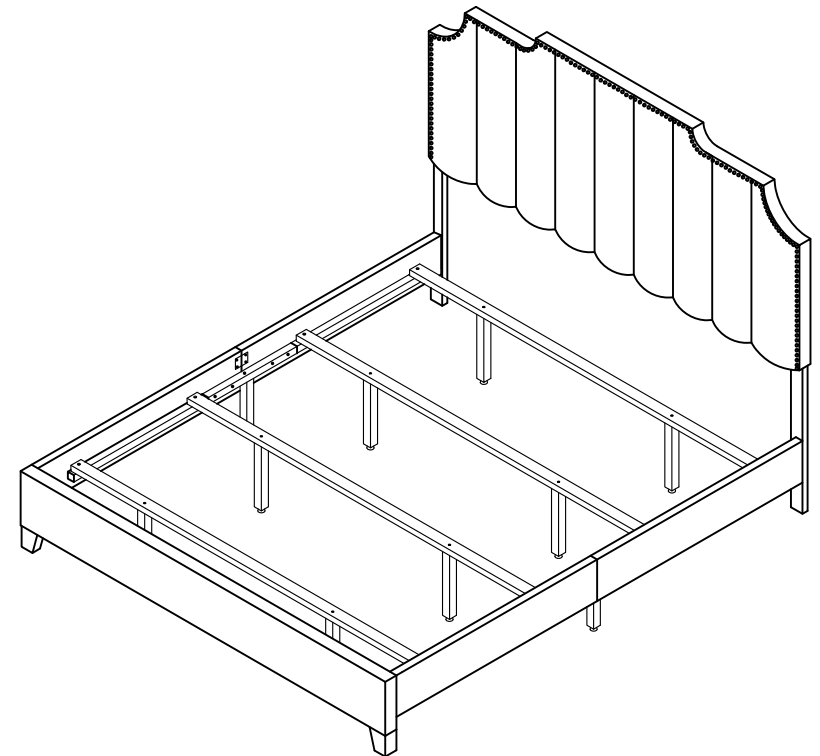

PREPARATION

Before beginning assembly of product, make sure all parts are present. Compare parts with package contents list and hardware contents list.

If any part is missing or damaged, do not attempt to assemble the product.

Estimated Assembly Time: 30 minutes.

Tools Required for Assembly (included): Allen Key

Important:
For correct assembly please ensure
the double hooks are latched properly.

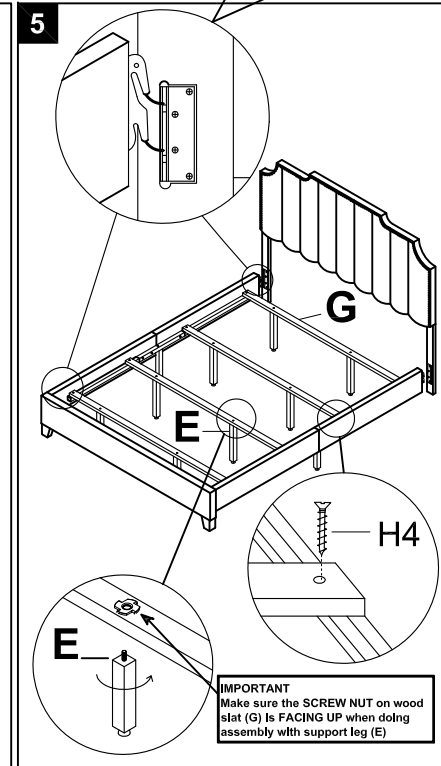
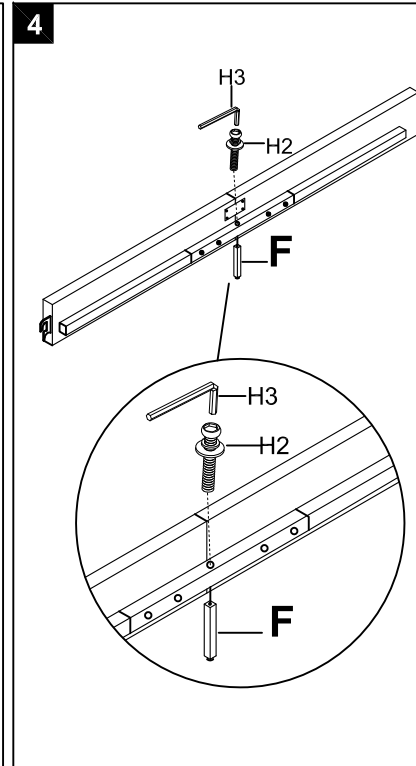
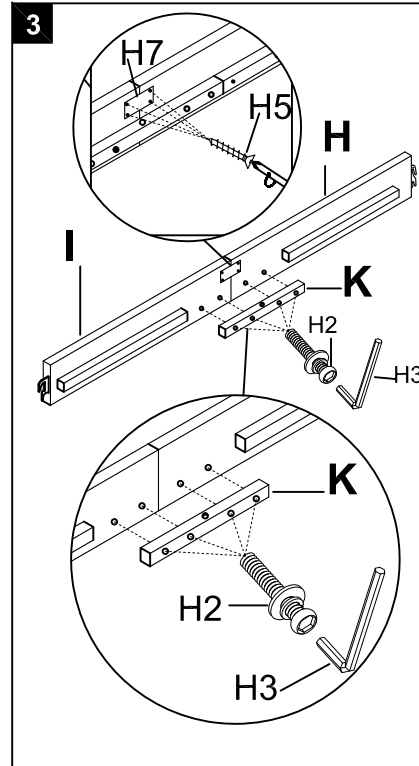
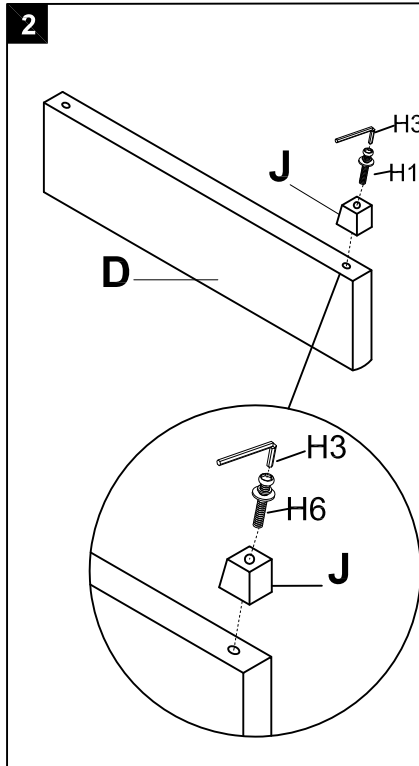
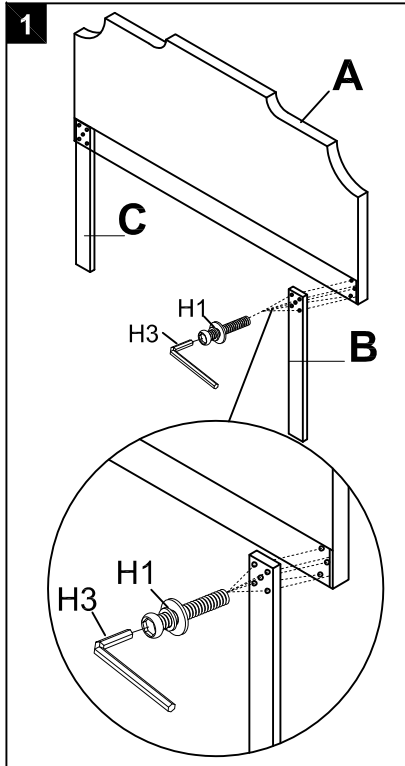

Step 1

Attach L/R posts "B" & "C" to headboard "A" by using Allen key (H3) to lock with bolts "H1".

Step 2

Attach wood legs "J" with footboard "D". Using Allen key (H3) to lock with bolts "H6".

Step 3

Attach wood bar "K" to the 2 rails "H" & "I". Using Allen key (H3) to lock with bolts "H2". Lock the both side rails (H & I) (front & rear of rail) tight and alignment with metal plate (H7) by using 8x screws (H5)

Step 4

Attach support legs "F" to wood bar "K". Using Allen key (H3) to lock with bolts "H2".

Step 5

Attach 2 rails to the L/R posts & the footboard assembled with legs. Attach 2 support legs (E) to each slat (G). Lock the slats tight with wood bar (both inside of rails) by using 8x screws (H4).

IMPORTANT
Make sure the SCREW NUT on wood
slat (G) is FACING UP when doing
assembly with support leg (E)