

Product Description & Information

Carefully Read This Instruction Manual Before Installing And Using This Product.

Please Keep This Instruction Manual For Future Reference For Product Operation And Maintenance.

Cleaning and Care

Care should be exercised when cleaning this product. Although its finish is extremely durable, it can be damaged by harsh abrasives and cleaning pads. Please use few and non-abrasive cleaning solution to clean and care.

TOOLS YOU WILL NEED:

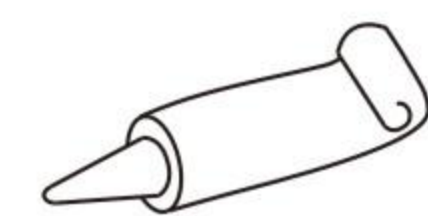

Plumber' s putty



Pipe tape

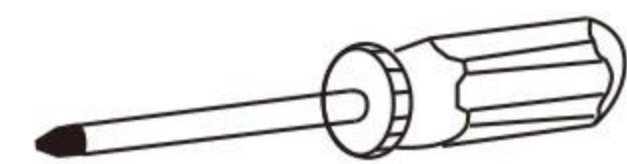

Philips screwdriver

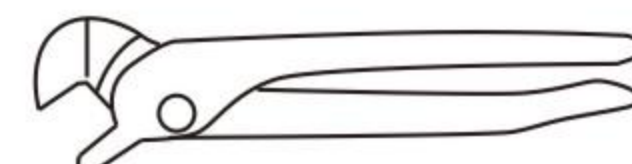

Pliers



Adjustable wrench

PACKAGE CONTENTS

- 1- Freestanding Tub Filler
- 1- Installation Accessories
- 1- Hand Shower and Shower Hose
- 1- Permanent Seat
- 1- Floor Escutcheon

FEATURES

- Elegant Brass Hand Shower
- Solid Brass Construction
- Ceramic Disc Cartridge



Product Features:
 Elegant Brass Hand Shower
 Solid Brass Construction
 Ceramic Disc Cartridge

Installation Instruction

Freestanding Tub Filler Faucet Manual

Note: This Instructions Book Is Written For General Use And Subject To Specification Variance Of Actual Parts

The product is cUPC certified.
 Original certification model code:DF-02038



For easy installation of your faucet please do the following

- Thoroughly read all instruction before installing the faucet.
- Read and understand all warnings, care and maintenance information.

Product Diagram and Parts

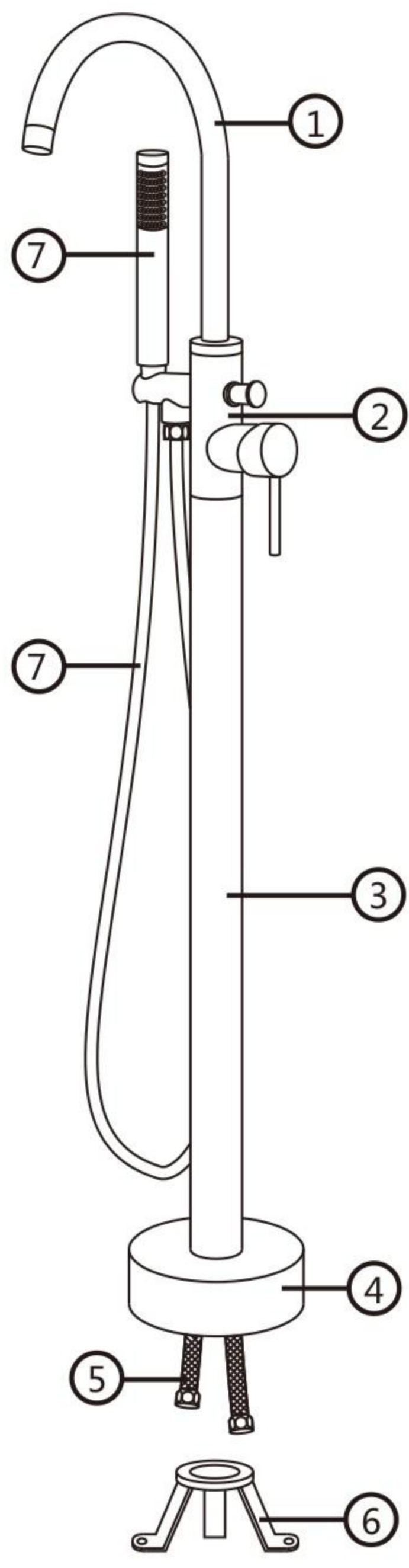

Accessory List:

- 1. Tub Filler Spout
- 2. Body
- 3. Standing Tube
- 4. Floor Escutcheon
- 5. Flexible hoses*2
- 6. Permanent Seat
- 7. Hand Shower and Hose
- 8. Expansion Screw

Faucet Installation Steps

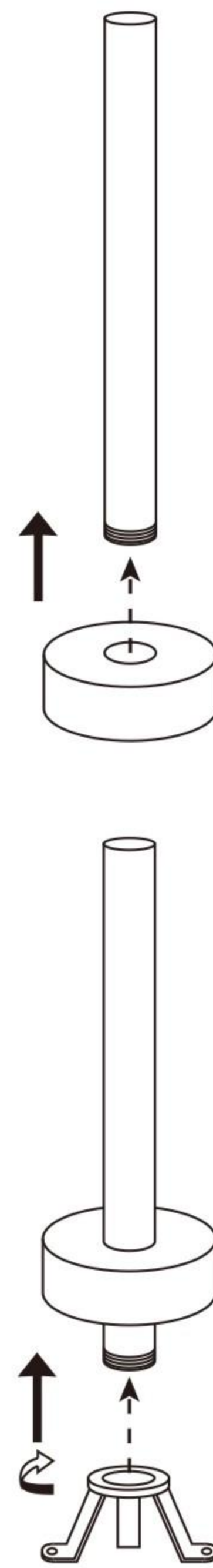

Step 1 The floor escutcheon through the straight tube from top to bottom.

Step 2 Installed the permanent seat.

Faucet Installation Steps

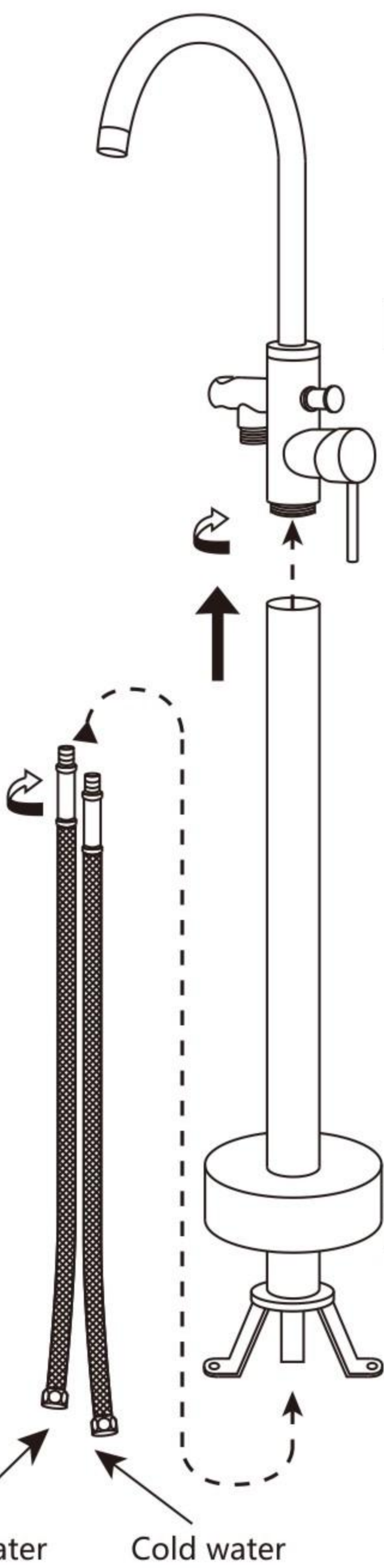

Step 3 The flexible hoses through the straight tube. Twist tight to attach flexible hoses to the faucet.

Step 4 Twist to tighten the straight tube to the top faucet.

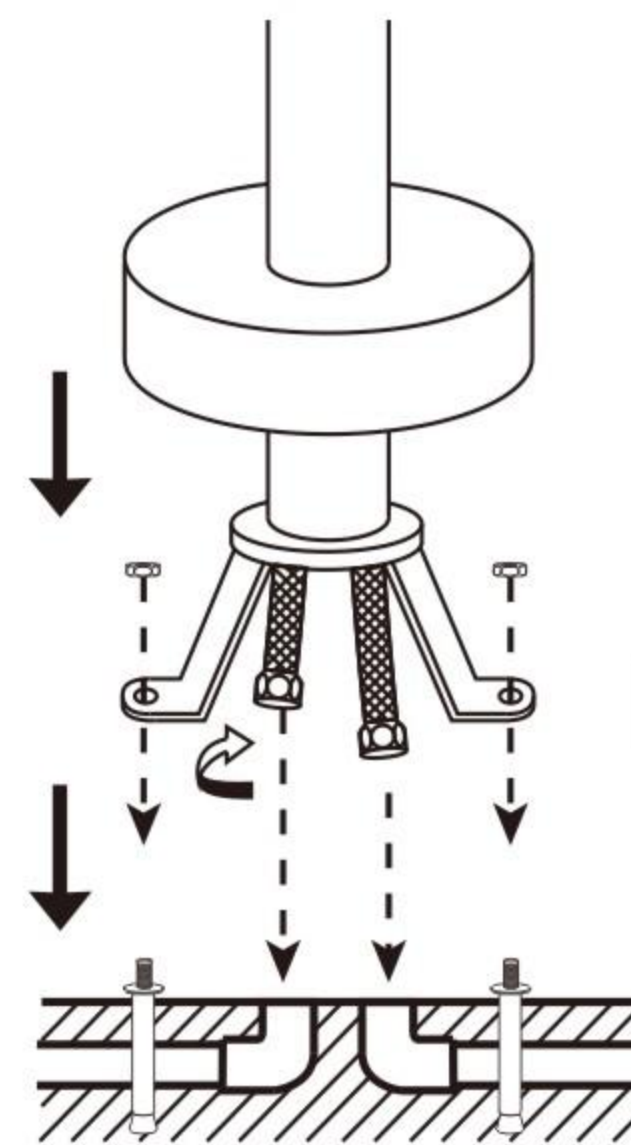

Step 5 Tighten the screws to the permanent seat on the ground. Insert the flexible hoses to the hot and cold outlet tube.

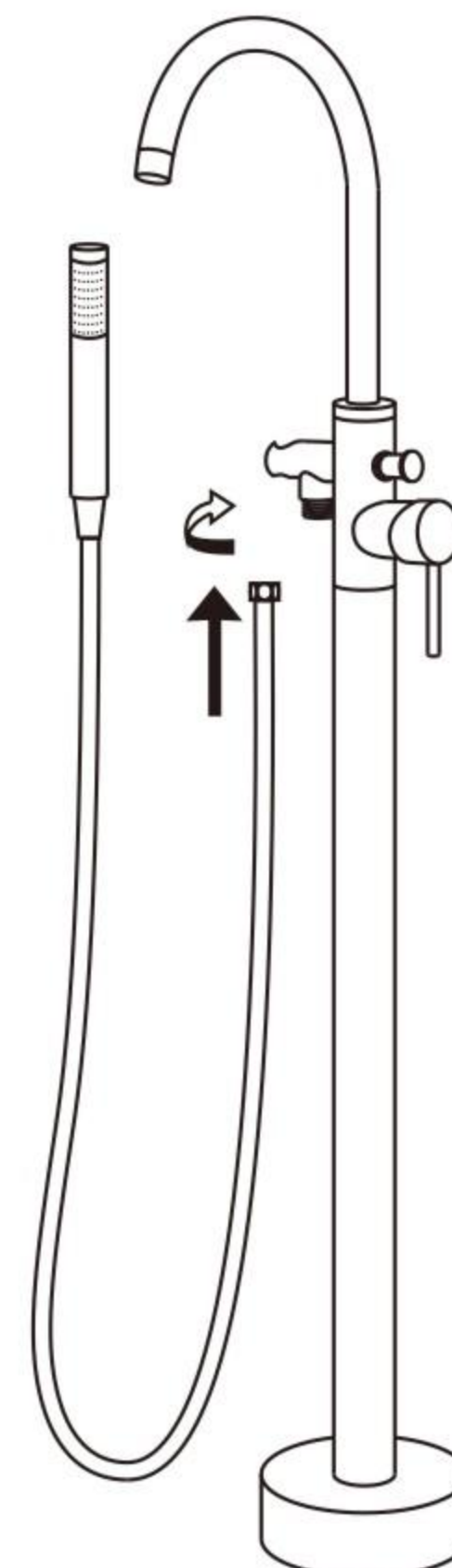

Step 6 Install the hose to the hand shower and the tub filler. Please check the tub filler spout and hand shower water flow and its function.

Hot water Cold water