

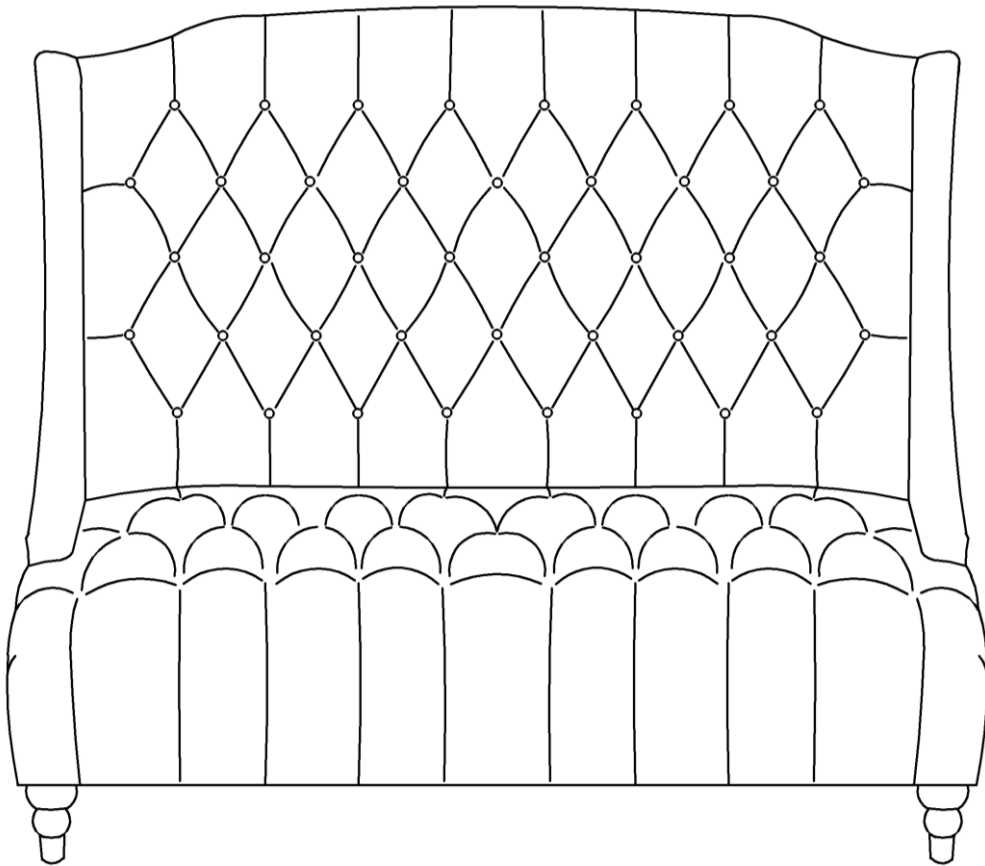

Assembly Instructions

Caution : You must read this before you proceed



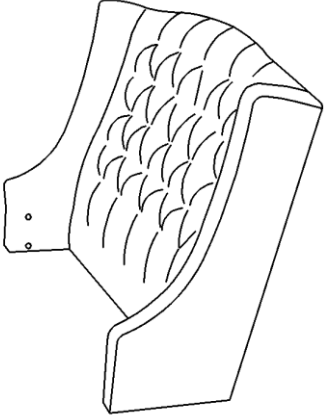
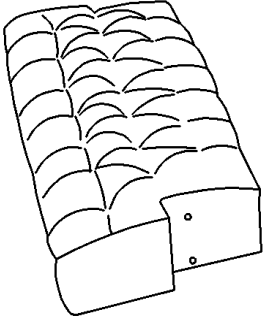
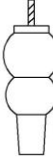

LOVESEAT



Parts List

Part NO.	Picture	Description	QTY
A		Sofa Back	1
B		Sofa Seat	1
C		Front Leg	2
D		Back Leg	2





Hardware

Label	Picture	Description	QTY
①		Bolt (M8*70mm)	6
②		Allen Key	1
③		Washer	6
④		Spring Washer	6
⑤		Gasket	7

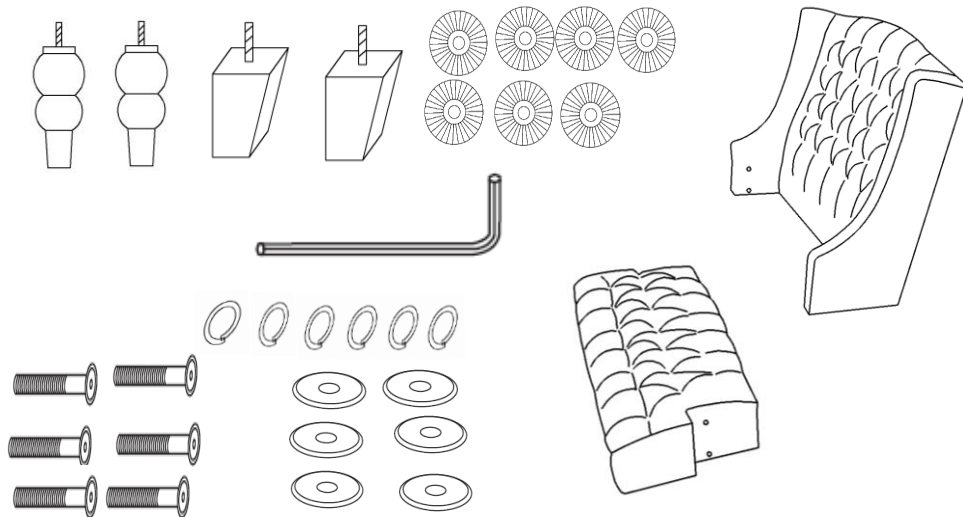
Assembly Preparation

Before Beginning Assembly:



-  • Read instructions, cover to cover-
-  • Have 2 adults on hand for assembly-
-  • Do not assemble on flooring or carpet-
-  • Assemble on a clean non-marring surface (packing foam)-
-  • Save all packaging until finished-

Assembly Steps

Overview

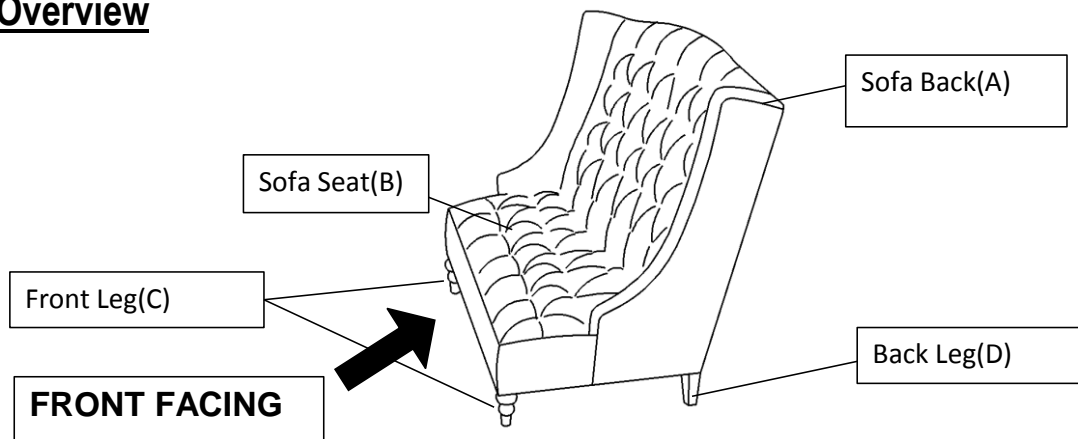

This Loveseat has multiple parts and may require up to 30 minutes to assemble.

To give you an overview of the Loveseat parts, the above picture is to help you put the various parts into perspective. Please read through the instructions below to familiarise yourself with the parts and steps before assembly.

Step 1

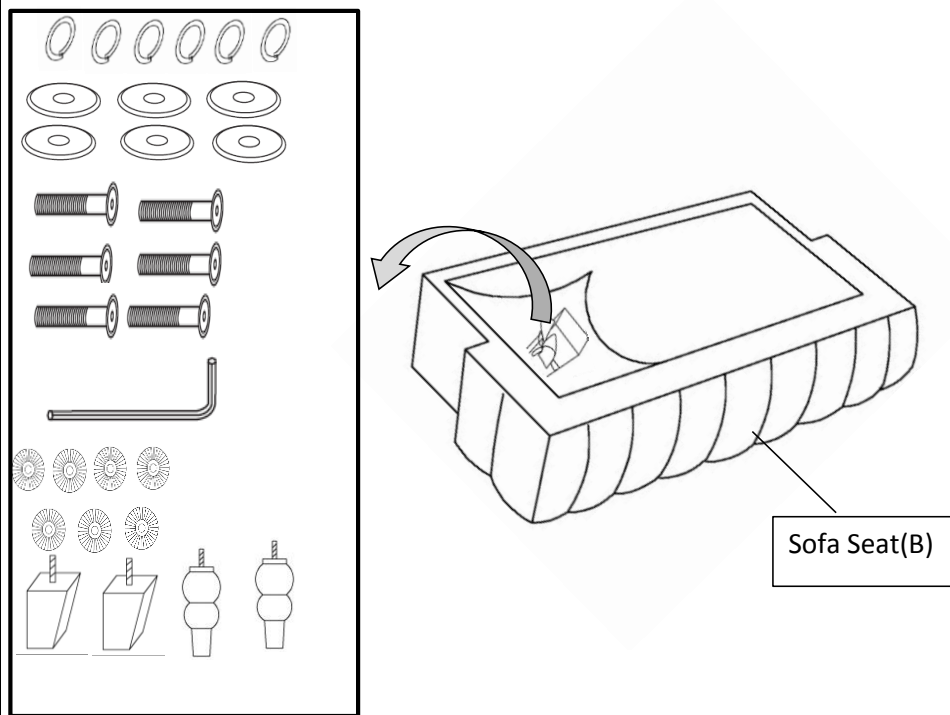

With assistance from your adult partners, position the Sofa Seat(B) on a clean, non-marring surface, as shown.

Unzip the pouch and remove the four Legs and Hardware.

Close the pouch before assembling.

Step 2

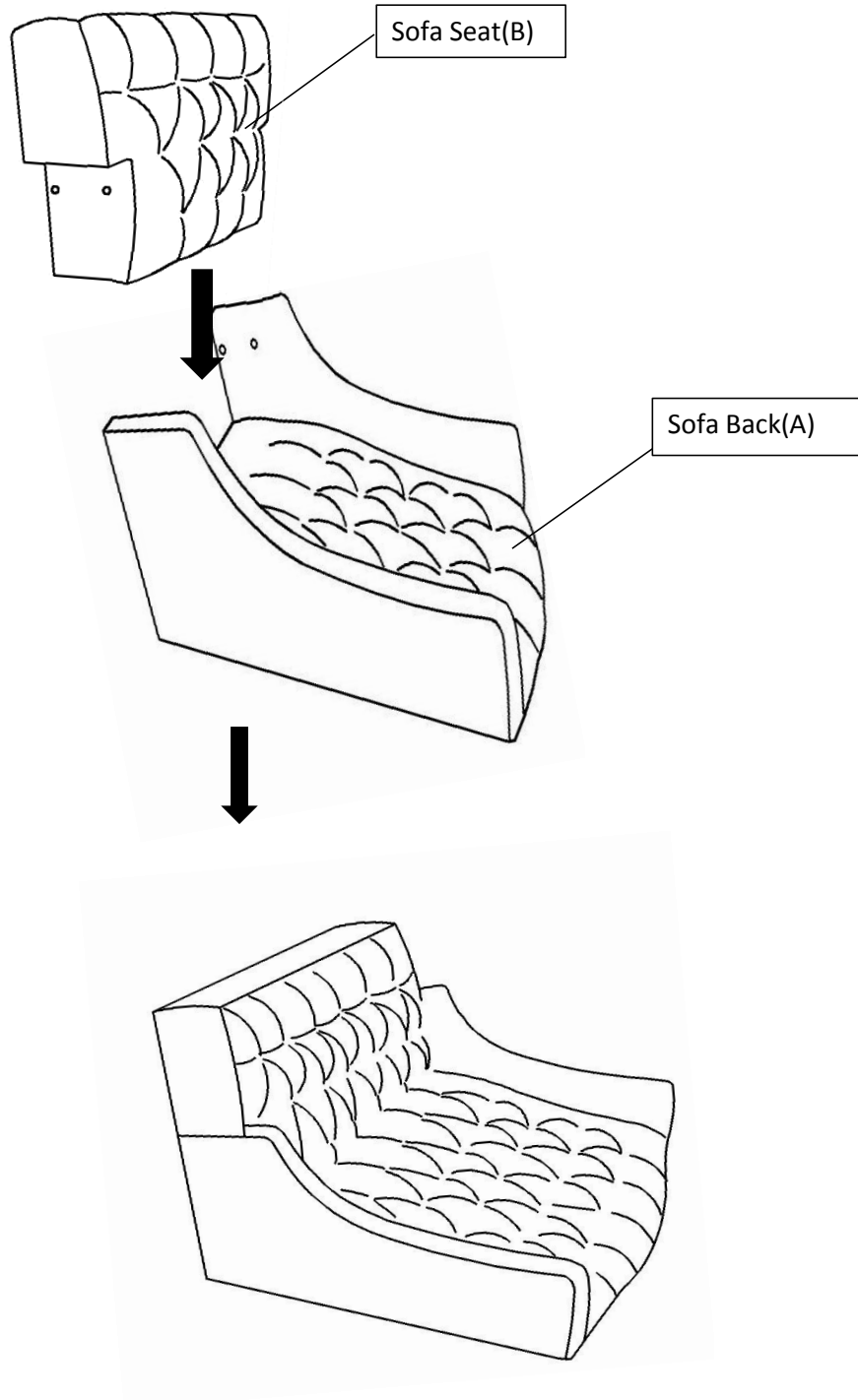

Insert the Sofa Seat(B) into Sofa Back(A) as shown above.

Step 3

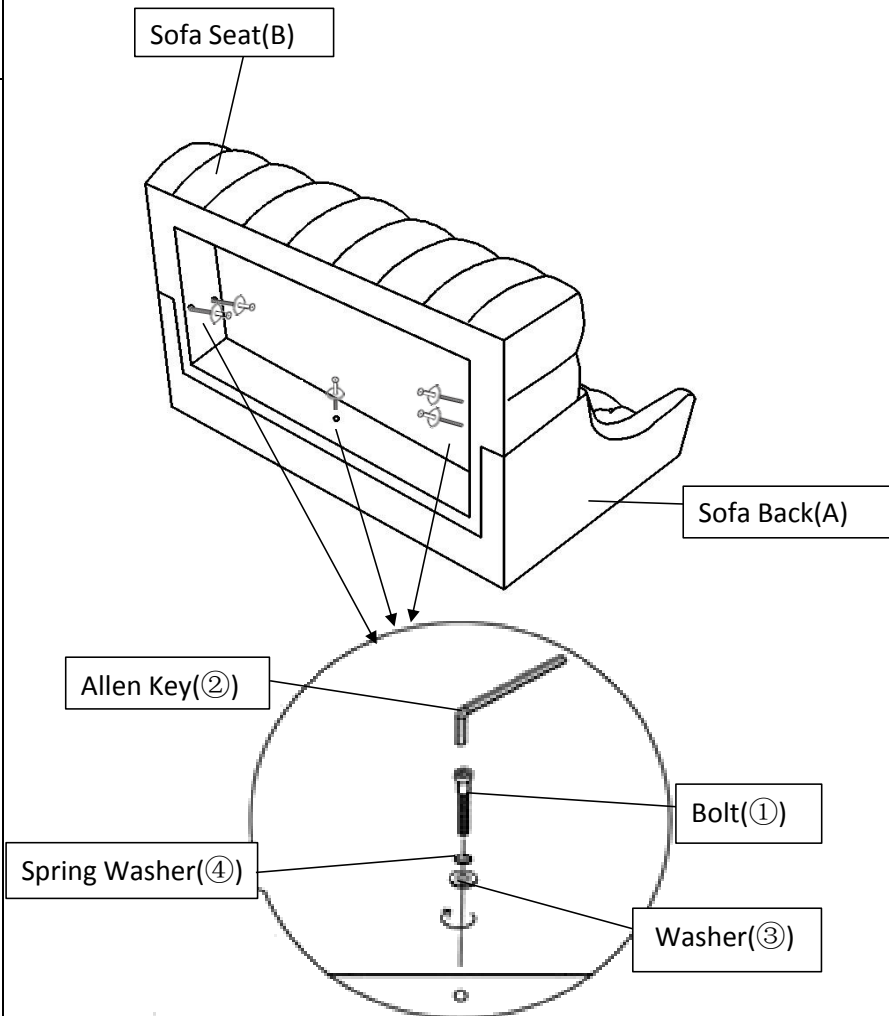

Attach Sofa Seat(B) to Sofa Back(A) at the side mounting positions using Bolts(①), Spring Washer(④) and Washer(③) with Allen Key(②). Repeat the same step to install the both sides. Use the Allen Key(②) to fasten all five bolts. Tighten all Bolts fully in a sequential manner.

Step 4

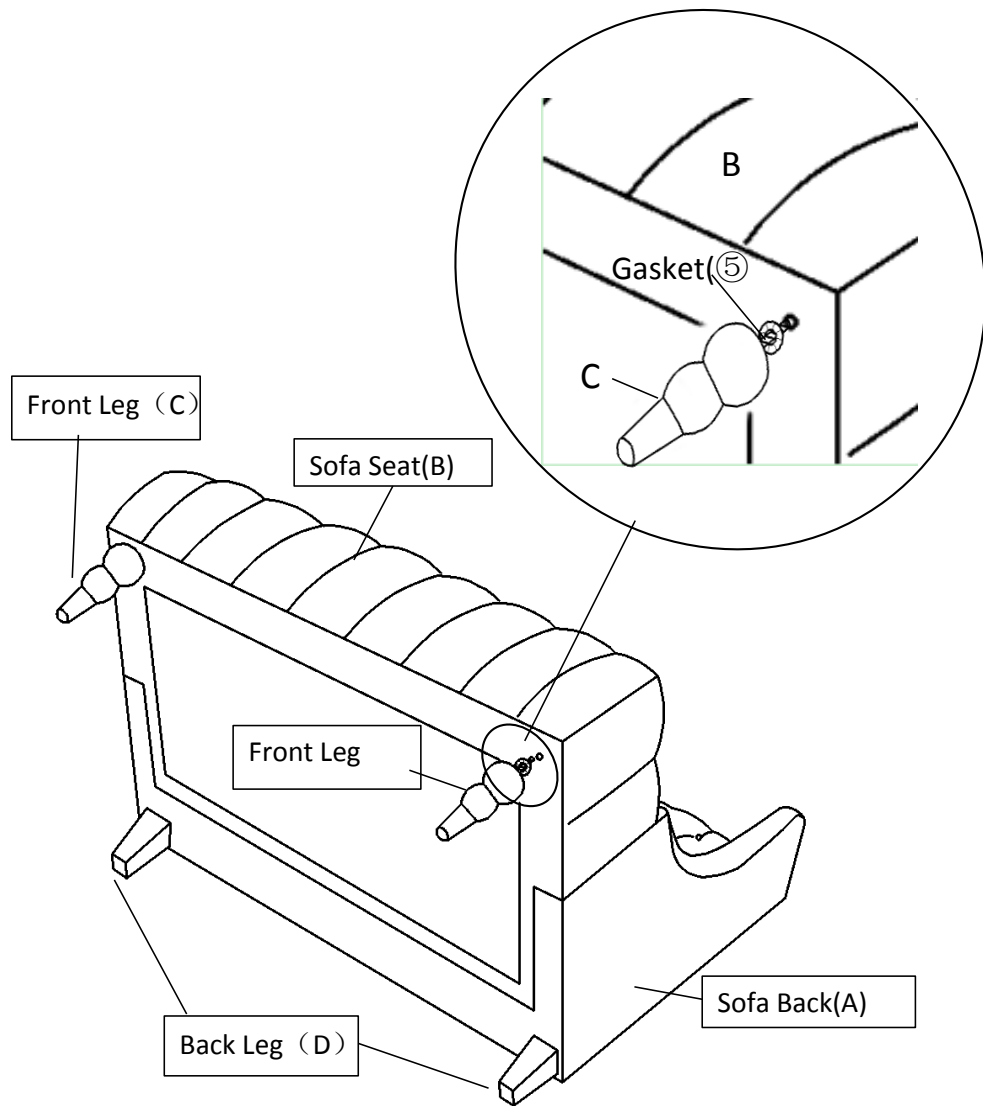

Install the first Front Leg(C) into the base of the Sofa Seat(B) by placing one Gasket(5) onto the threaded stem.

Then, insert the threaded stem of the Front Leg(C) into the front mounting position of the Sofa Seat(B) and tighten by turning the Leg clockwise until it is completely secure.

Repeat this process with the remaining three Legs.





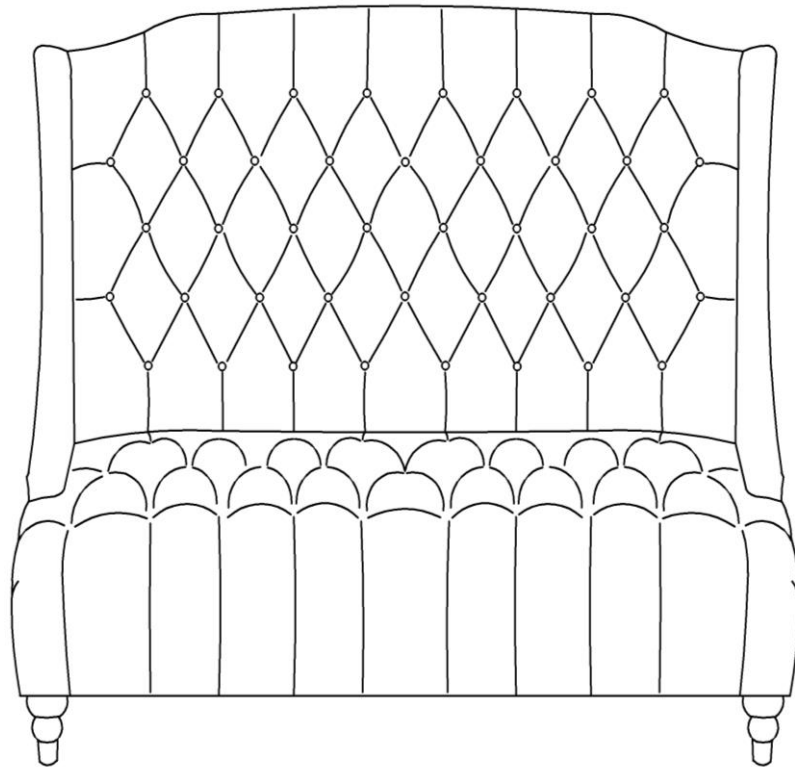



Note: The use of the Gaskets are OPTIONAL and are especially useful to help alleviate slight wobbles. Some Legs may need more than one whilst some Legs may not need any.

Step 5



Make sure all parts are connected and fully locked into position.
Your Loveseat is ready for use.
This Loveseat can only be used on a flat, level surface.

Care & Maintenance

-  Do not put hot items directly on furniture surface
-  Do not clean furniture with harsh cleansers or polish.
-  Do not place furniture under direct sunlight.
-  Do not place furniture near heating or cooling vents.
-  Do not write on furniture without a padded barrier to protect the surface.
-  Do not place furniture outside . For indoor use only .
-  Not for commercial use. For residential use only .
-  Stains may be removed with mild soap solution and damp cloth.
-  Children should not climb or jump on the furniture.

-
-  Dust and pick-up spills using a clean, non-colored, lint-free cloth .

What is Proposition 65?

Proposition 65 is a California law that requires warning labels on products that may contain one of more than 800-plus chemicals or ingredients that the California Office of Environmental Health Hazard Assessment (OEHHA) has deemed to cause cancer or other reproductive toxicity. Chemicals and elements on this list include wood dust, brass, and other everyday substances, which can be found in very common household items, such as: lamps, tableware, jewelry, crystal glasses, electric cords, beauty products, automobiles, and furniture.

Why Did I Find a Proposition 65 Warning on My Home Goods Product?

We include Proposition 65 warnings on all of our products because there is always a chance that one of the 800-plus common chemicals and ingredients listed under this law could potentially be on our furniture or packing materials. We risk large fines under this law, if we don't include this warning.

Should I worry?

We realize you may be worried finding this warning on our products, but we want to reassure you that the hazardous exposure limits for any of these chemicals have never been found on furniture products that we've shipped to our customers. Additionally, this warning label is very common and can be found on almost every piece of furniture sold in the state of California.

Just How Common Are Proposition 65 Warnings?

Proposition 65 warnings have become so common in California that it is hard to take a trip to a local bank, grocery store, or restaurant without finding at least one warning. In fact, even the Disney Land Resort has a Proposition 65 warning:

