

# Assembly Instructions

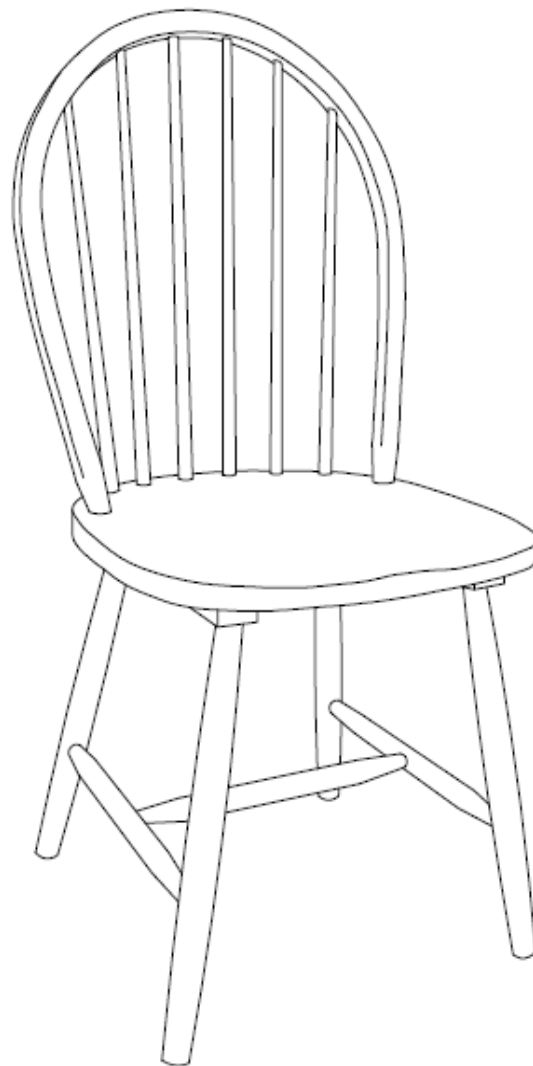

**Caution: You must read this before you proceed.**

## SPINDLE BACK CHAIR







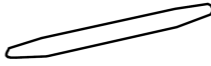

**WARNING:** These chairs are intended only for normal use with all four chair legs on the ground. These consumer chairs have relatively thin legs and are not designed to be sat in with only two chair legs on the ground (as from tipping back, forward, or to the side), and such can cause stress and failure of one or more chair legs. Any misuse of the chairs voids any warranties, express or implied.

# Parts List

Part NO.	Picture	Description	QTY
A		Chair / Seat	1 PC
B		Left Leg Frame(Mark With FL)	1 PC
C		Right Leg Frame(Mark with RL)	1 PC
D		Middle Support Rail	1 PC

# Hardware

E		JCBC Bolt(M6*50MM)	2 PCS
F		Barrel Nut	2 PCS
G		Screw(M7*35mm)	6 PCS
H		Allen Key	1 PC
J		Wood Button	2 PCS
K		Foam Pad	4 PCS
L		Screwdriver	Not Provided

# Assembly Preparation

Before Beginning Assembly:

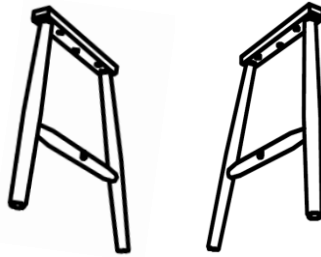
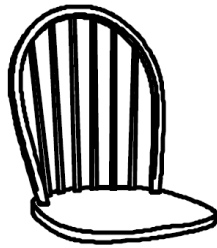

- Read instructions, cover to cover-



- Have 2 adults on hand for assembly-



- Do not assemble on flooring or carpet-



- Assemble on a clean non-marring surface (packing foam)-



- Save all packaging until finished-

# Assembly Steps

## Parts Introduction

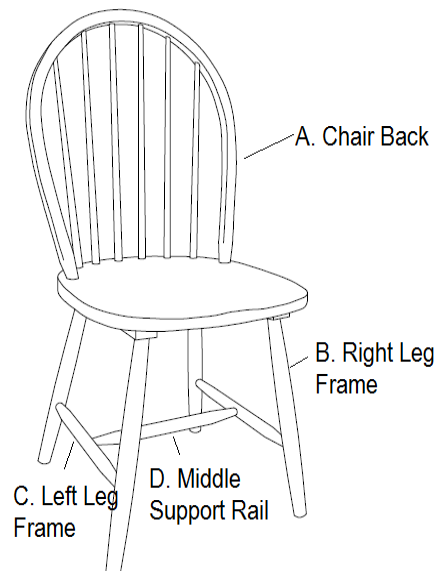

**This Spindle Back Chair has multiple parts and may require up to 20 minutes to assemble. To give you an overview of the Chair parts, the above picture is to help you put the various Chair parts into perspective.**

**Please read through the instructions herebelow to familiarise yourself with the parts and steps before assembly.**

Step 1

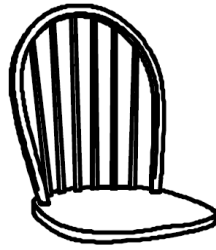

A. Chair/Seat

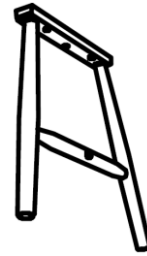

B. Right Leg Frame



C. Left Leg Frame

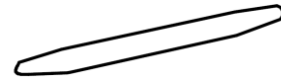

D. Middle Support Rail

Place the Chair/Seat(A) on a clean, non-marring surface.  
take out all of the Parts and Hardware.

Step 2

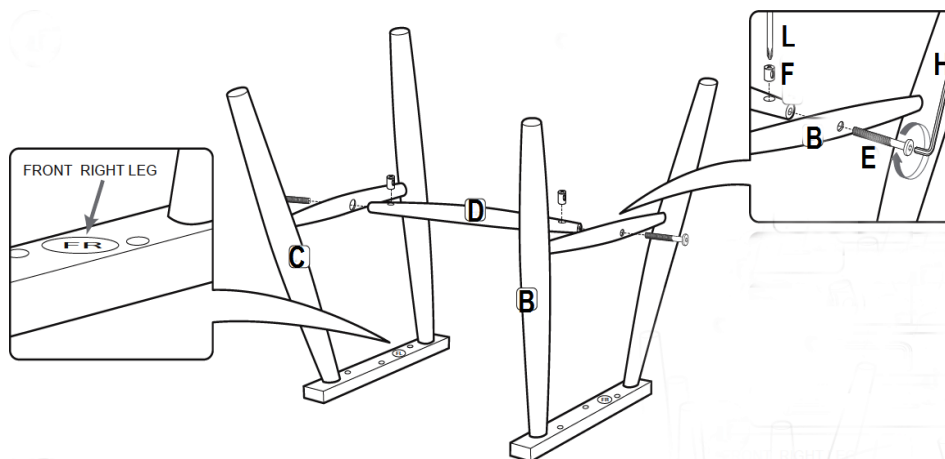

Insert Barrel Nut(F) into the holes on Middle Support Rail(D),and use Screwdriver(L) to adjust the Barrel Nut(F) mounting position.

Attach the Left Leg Frame(B) to Middle Support Rail(D) by inserting JCBC Bolt(E) into Barrel Nut(F) with Allen Key(H) as showed in above.

Repeat the same process with the Right Leg Frame(C).

**Only loosley tighten the Bolts.**

**Step 3**

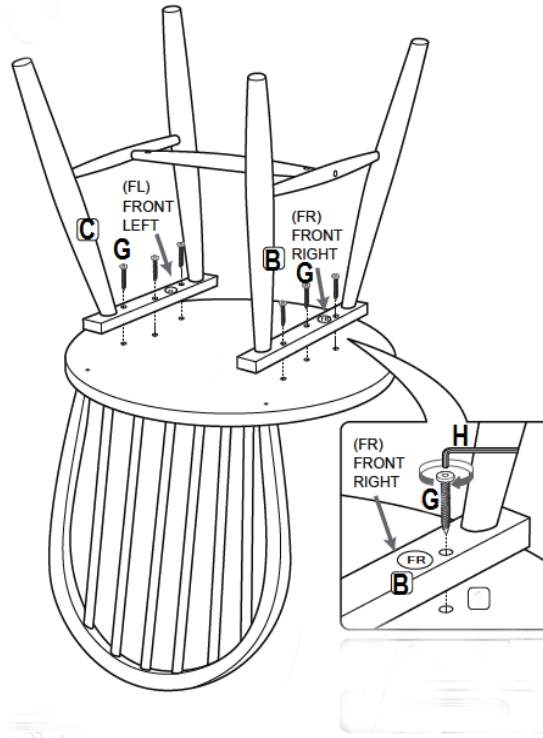

Position the Leg Frame onto the bottom of Chair Seat(A).  
Align and attach Chair Back(A) and Leg Frame using Screws(G) with Screwdriver(L).  
**Proceed to tighten all the bolts**

**Note: Front Legs must be facing the front.**

**Step 4**

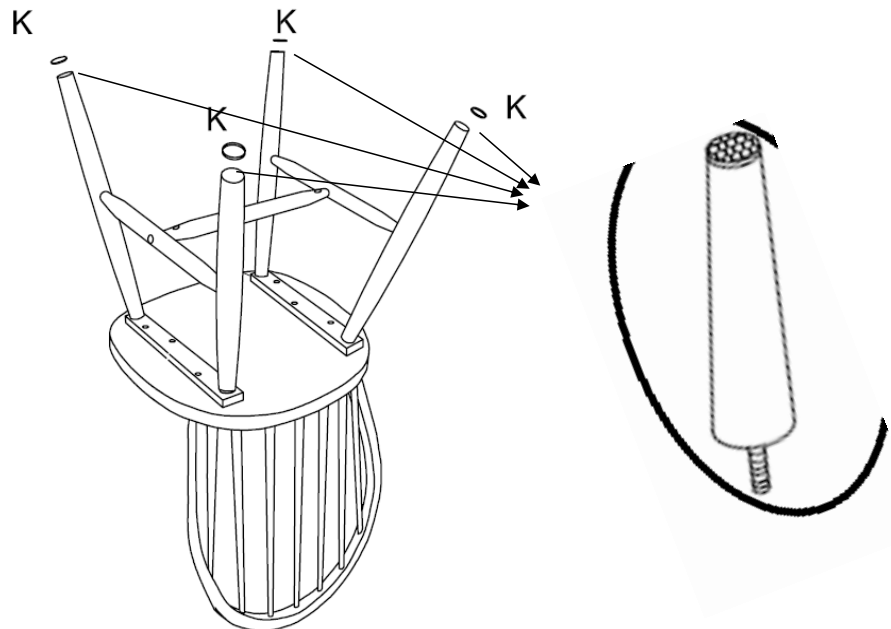





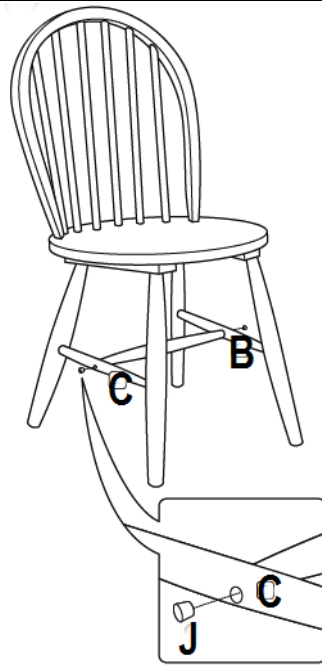





Adhere the Foam Pad(K) under the Legs.

Step 5



Stand the Spindle Back Chair rightside up.  
Insert the wood button(G) into the leg support rail screw Hole  
Your Spindle Back Chair is ready for use.

## Care & Maintenance

-  ● Do not put hot items directly on furniture surface
  -  ● Do not clean furniture with harsh cleansers or polish.
  -  ● Do not place furniture under direct sunlight.
  -  ● Do not place furniture near heating or cooling vents.
  -  ● Do not write on furniture without a padded barrier to protect the surface.
  -  ● Do not place furniture outside . For indoor use only .
  -  ● Not for commercial use. For residential use only .
  -  ● Stains may be removed with mild soap solution and damp cloth.
  -  ● Children should not climb or jump on the furniture.
- 
-  ● Dust and pick-up spills using a clean, non-colored, lint-free cloth .

### What is Proposition 65?

Proposition 65 is a California law that requires warning labels on products that may contain one of more than 800-plus chemicals or ingredients that the California Office of Environmental Health Hazard Assessment (OEHHA) has deemed to cause cancer or other reproductive toxicity. Chemicals and elements on this list include wood dust, brass, and other everyday substances, which can be found in very common household items, such as: lamps, tableware, jewelry, crystal glasses, electric cords, beauty products, automobiles, and furniture.

### Why Did I Find a Proposition 65 Warning on My Home Goods Product?

We include Proposition 65 warnings on all of our products because there is always a chance that one of the 800-plus common chemicals and ingredients listed under this law could potentially be on our furniture or packing materials. We risk large fines under this law, if we don't include this warning.

### Should I worry?

We realize you may be worried finding this warning on our products, but we want to reassure you that the hazardous exposure limits for any of these chemicals have never been found on furniture products that we've shipped to our customers. Additionally, this warning label is very common and can be found on almost every piece of furniture sold in the state of California.

### Just How Common Are Proposition 65 Warnings?

Proposition 65 warnings have become so common in California that it is hard to take a trip to a local bank, grocery store, or restaurant without finding at least one warning. In fact, even the Disney Land Resort has a Proposition 65 warning:

