

ASSEMBLY INSTRUCTIONS

Components

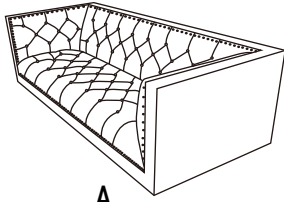

A
x1

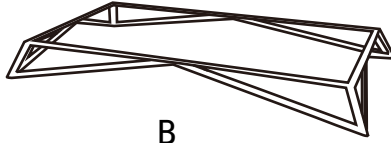

B
x1

Hardware

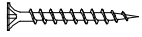

a
x10

Assembly Instructions

STEP 1

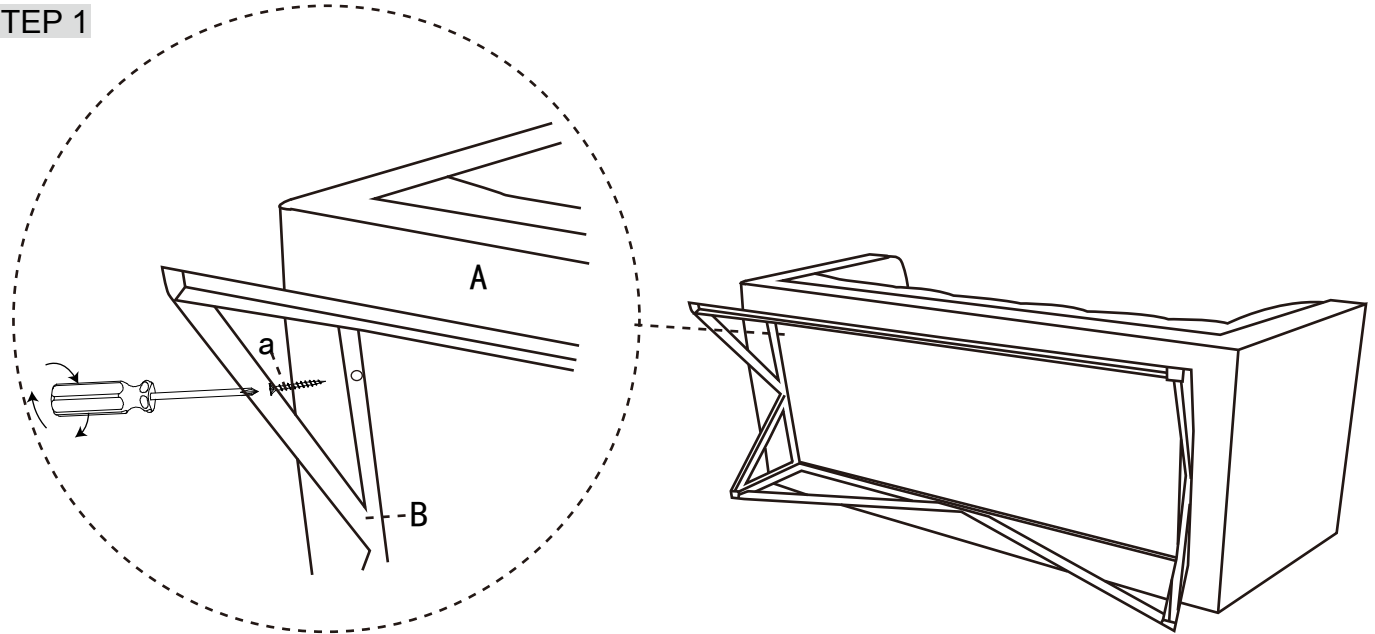

STEP 2

