



33 35TH STREET, INDUSTRY CITY BLDG.5, A405, BROOKLYN, NY 11232
T 212.355.0625 F 212.355.0628 WWW.OASIQ.COM



440-OTS Ottoman

W 24 1/2" D 24 1/2" H 10 1/2"

OSH 14 1/2"

23 lbs

Teak

Cushion: 440-OTS-X

L 24 1/2" W 24 1/2" H 4"

FABRIC AVAILABLE FOR ASTOR, HAMILTON, MADISON, DELANCEY & LIMITED COLLECTIONS



Canvas Natural 5404-0000

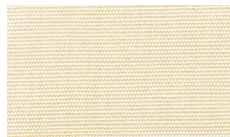

Canvas Vellum 5498-0000

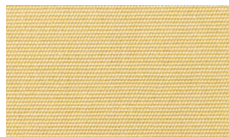

Canvas Wheat 5414-0000

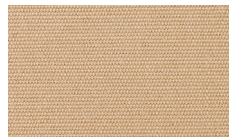

Canvas Camel 5468-0000



Canvas Granite 5402-0000

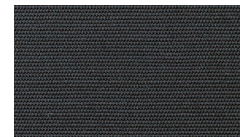

Canvas Black 5408-0000



Canvas Buttercup 5438-0000

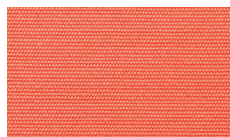

Canvas Melon 5415-0000

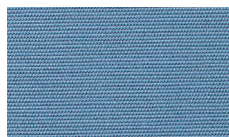

Canvas Sapphire Blue 5452-0000



Canvas Sky Blue 5424-0000

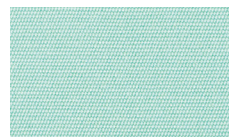

Canvas Glacier 5428-0000

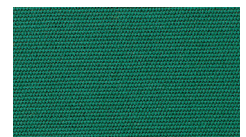

Canvas Forest Green 5446-0000

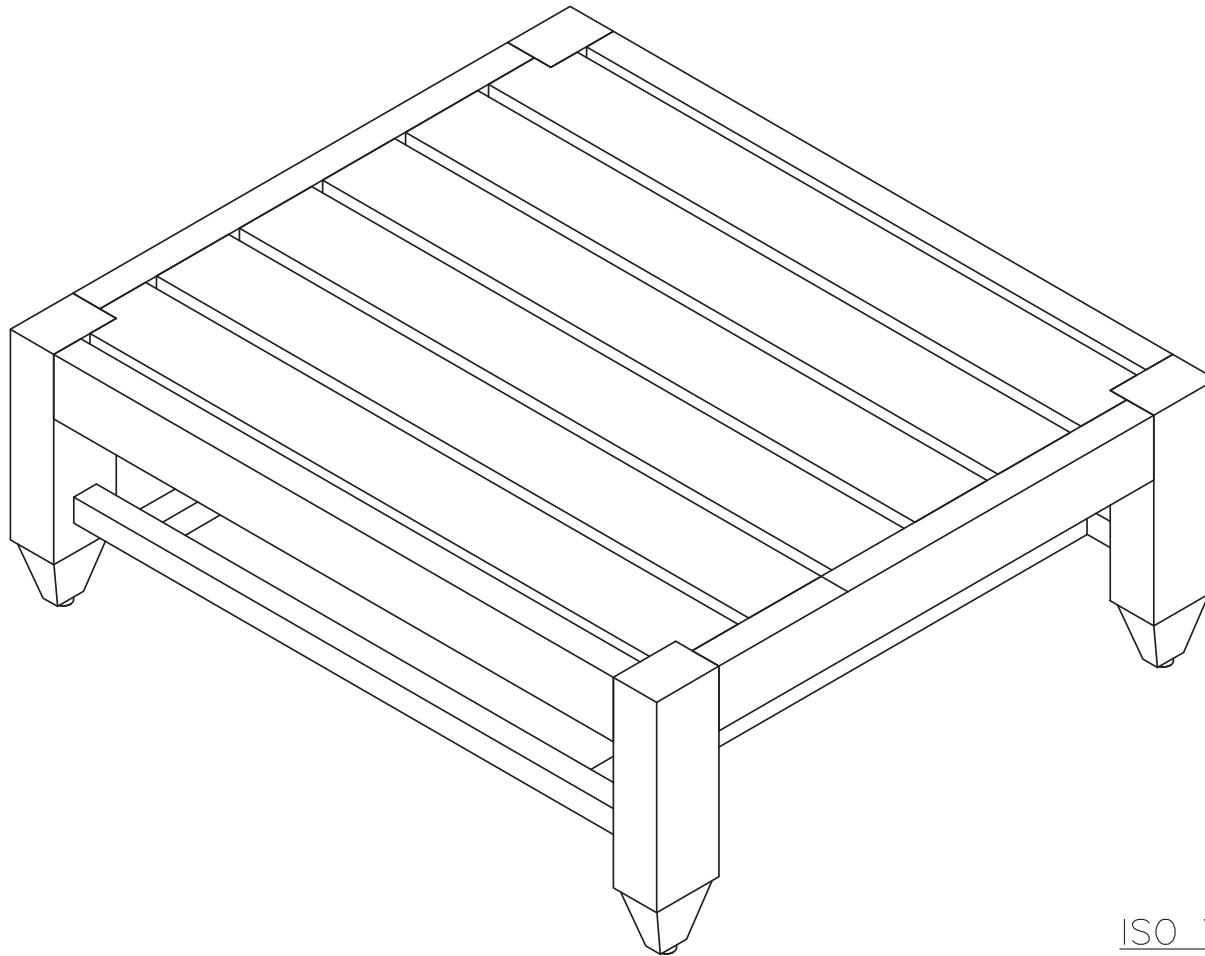

ISO VIEW

ISO

OASIQ

DWG.NO: FAEDG0003T-6

TITLE : ISO VIEW

DIM EXT: 622.2x622.2x266 MM.

MATERIAL: TEAK

DRAWN BY : XU

FINISH DATE : 22/02/08
BEGIN DATE : 22/02/08

XU
XU
SCALE :
no scale

P. 3

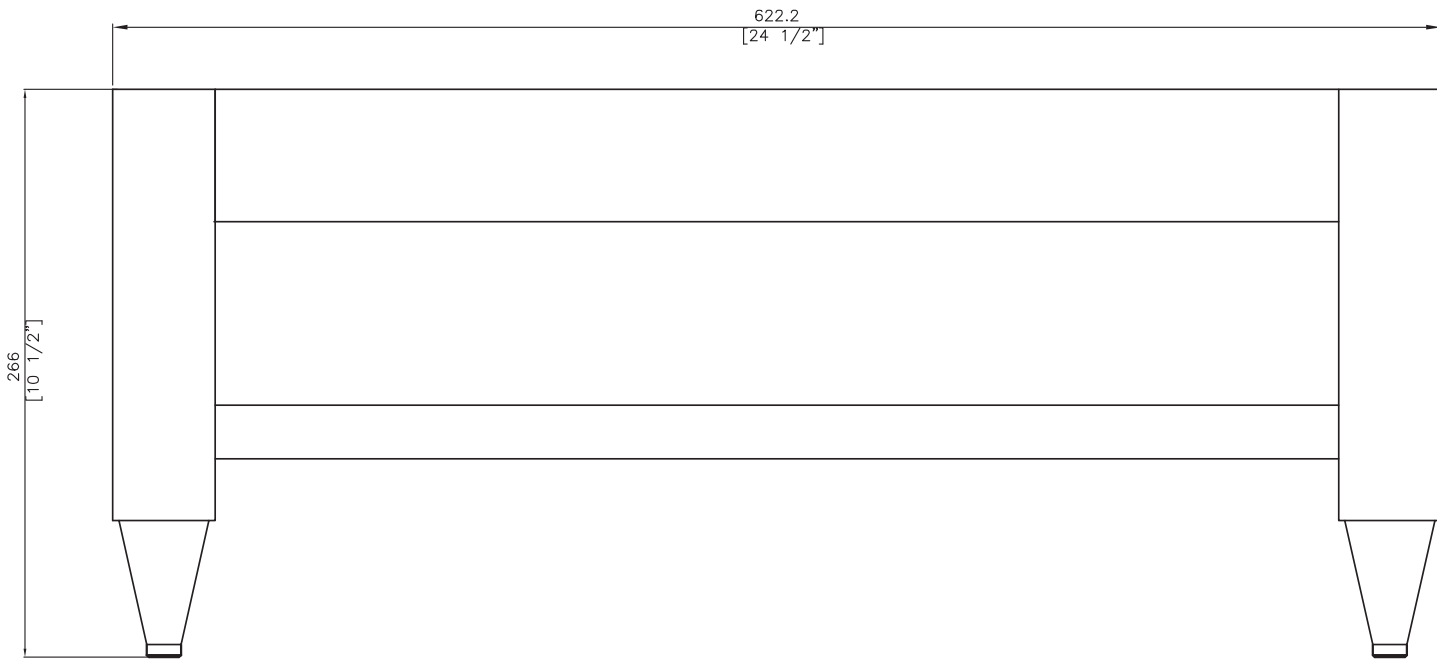

FRONT

EF

OASIQ

DWG.NO: FAEDG0003T-6

TITLE : FRONT

DIM EXT: 622.2x622.2x266MM

MATERIAL: TEAK

DRAWN BY : XU

FINISH DATE : 22/02/08	XU
BEGIN DATE : 22/02/08	XU

SCALE :
no scale

P. 5

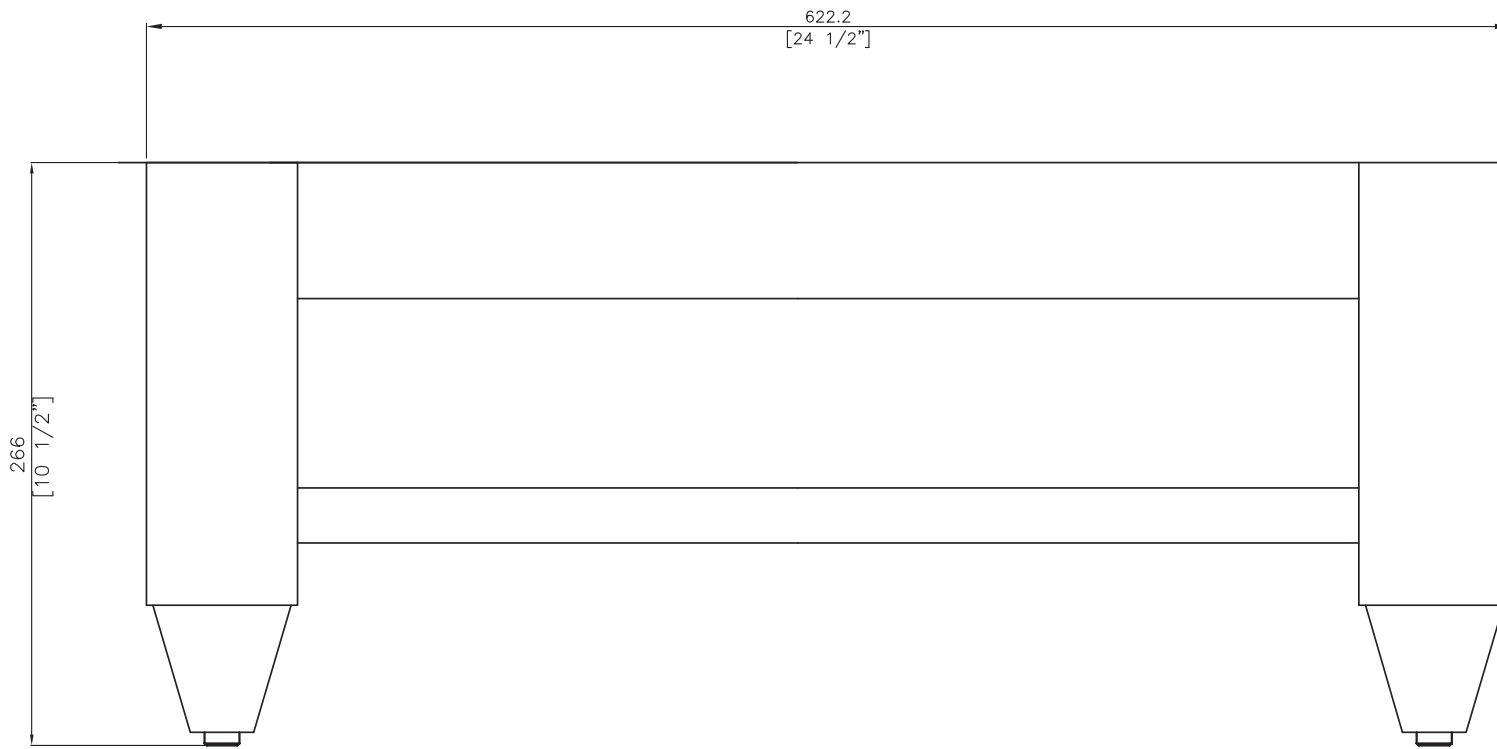

SIDE

ES

OASIQ

DWG.NO: FAEDG0003T-6

TITLE : SIDE

DIM EXT: 622.2x622.2x266MM.

MATERIAL: TEAK

DRAWN BY : XU

FINISH DATE : 22/02/08	XU
BEGIN DATE : 22/02/08	XU

SCALE :
no scale

P. 6

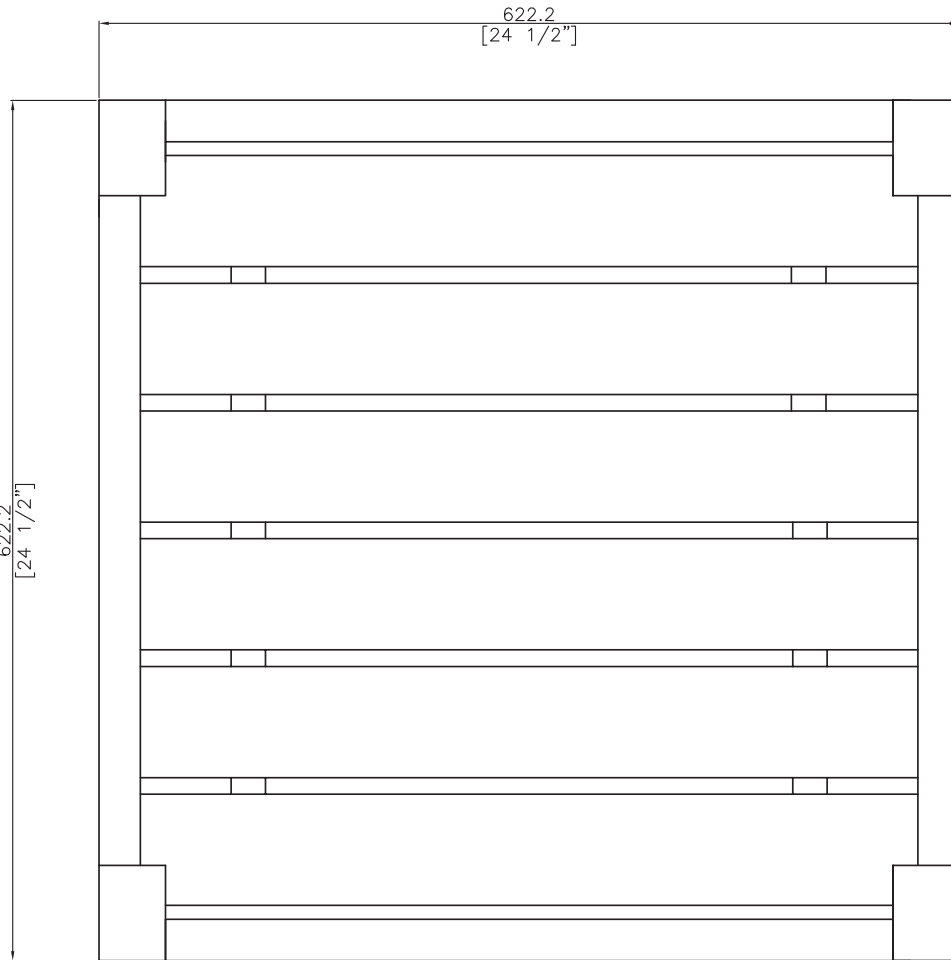

TOP

ET

OASIQ

DWG.NO: FAEDG0003T-6

TITLE : TOP

DIM EXT: 622.2x622.2x266 MM.

MATERIAL: TEAK

DRAWN BY : XU

FINISH DATE : 22/02/08	XU
BEGIN DATE : 22/02/08	XU

SCALE :
no scale

P. 4