

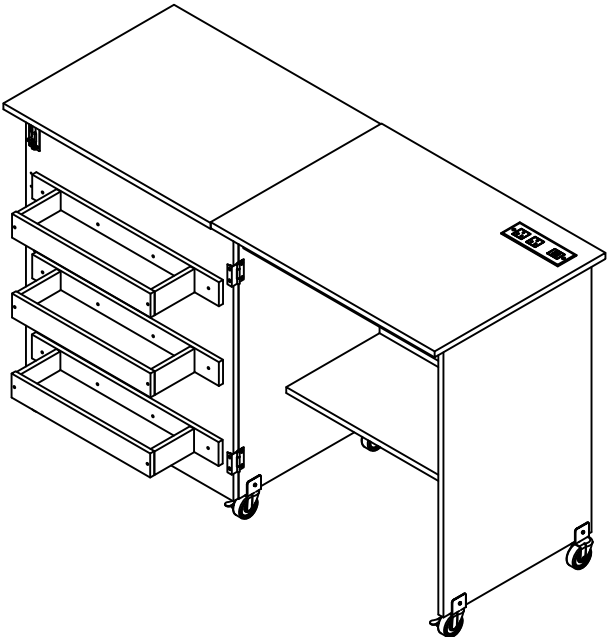

FTHKSG-1003

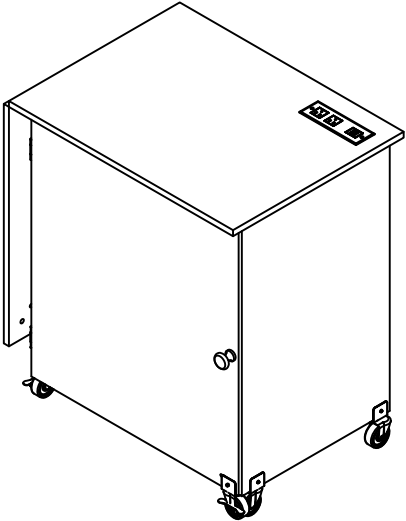

Parts List

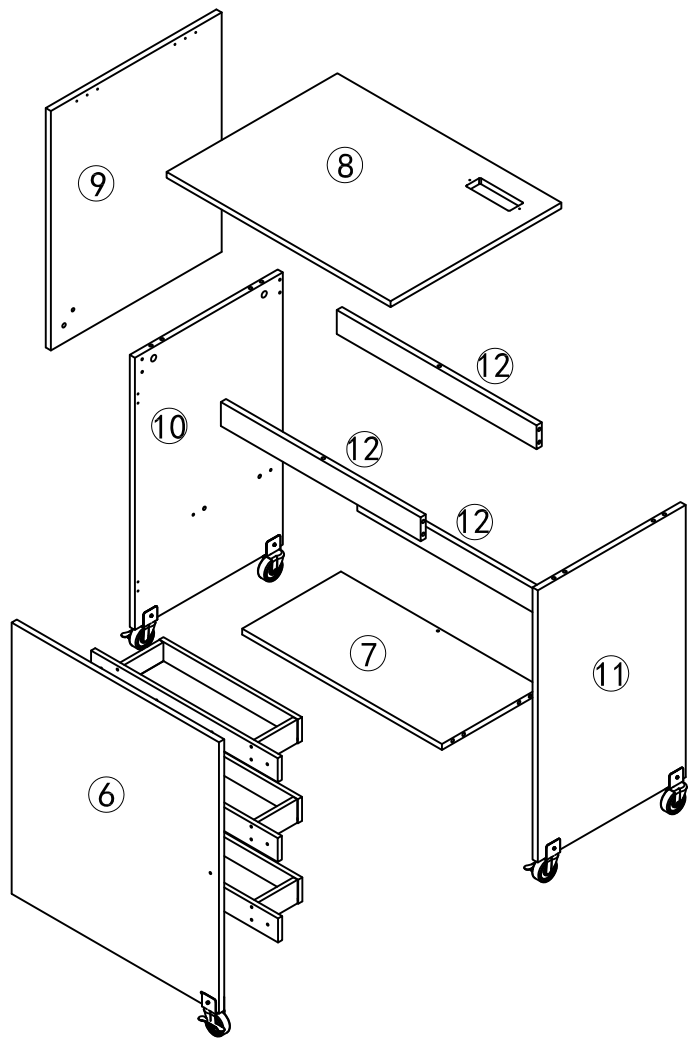
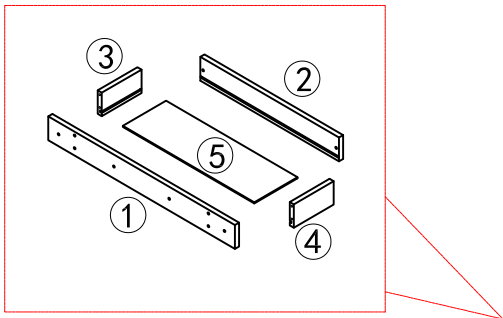

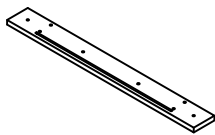

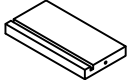
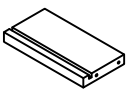
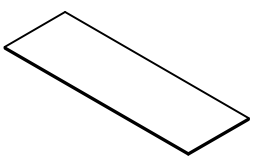
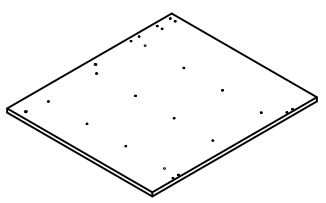
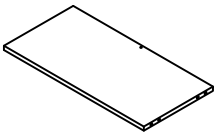
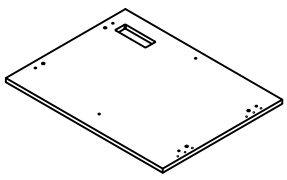
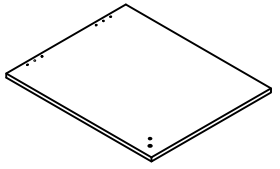
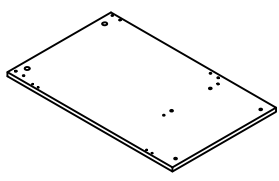
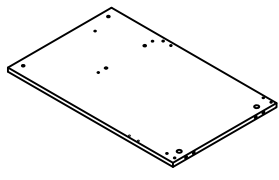
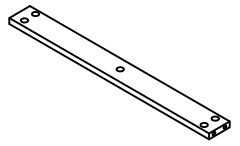



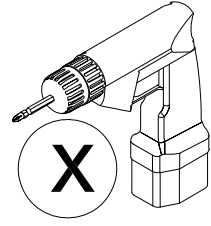
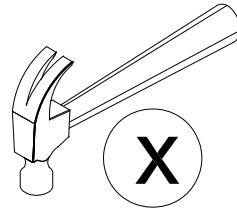
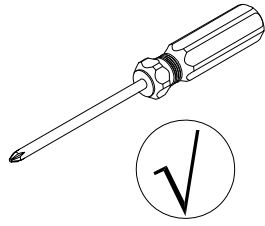
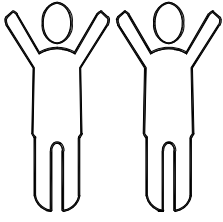



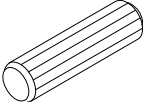

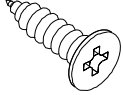
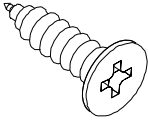
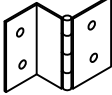
Hardware List

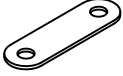
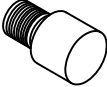
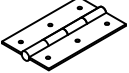
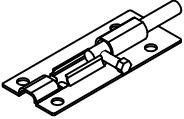
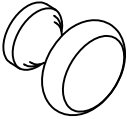
<p>1</p>  <p>3 PC</p>	<p>2</p>  <p>3 PC</p>	<p>3</p>  <p>3 PC</p>
<p>4</p>  <p>3 PC</p>	<p>5</p>  <p>3 PC</p>	<p>6</p>  <p>1 PC</p>
<p>7</p>  <p>1 PC</p>	<p>8</p>  <p>1 PC</p>	<p>9</p>  <p>1 PC</p>
<p>10</p>  <p>1PC</p>	<p>11</p>  <p>1PC</p>	<p>12</p>  <p>1PC</p>

Hardware List



<p>A</p>  <p>Ø6*35MM 23PCS</p>	<p>B</p>  <p>Ø15*9.5MM 23PCS</p>	<p>C</p>  <p>Ø8*30MM 8PCS</p>	<p>D</p>  <p>Ø4*22MM 30PCS</p>
<p>E</p>  <p>Ø3*15MM 16PCS</p>	<p>F</p>  <p>Ø4*15MM 14PCS</p>	<p>G</p>  <p>41*35*19MM 2PCS</p>	<p>H</p>  <p>1PCS</p>
<p>I</p>  <p>1PCS</p>	<p>J</p>  <p>1PCS</p>	<p>K</p>  <p>2PCS</p>	<p>L</p>  <p>1PCS</p>
<p>M</p>  <p>1PCS</p>	<p>N</p>  <p>Ø4*25MM 1PCS</p>	<p>O</p>  <p>Ø20MM 14PCS</p>	<p>P</p>  <p>1PCS</p>
<p>Q</p>  <p>3PCS</p>	<p>R</p>  <p>2PCS</p>	<p>S</p>  <p>ØM6*25MM 5PCS</p>	

Assembly Steps

CAM BOLT INSTALLATION AS BELOW:

 Cam bolt

 Connecting piece

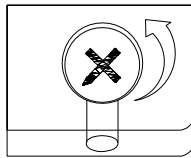

X

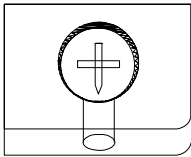

✓

Rotate connecting piece if found in the position illustrated above.

Correct orientation to receive bolts.

Pin

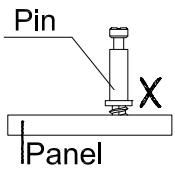

Panel

No gap

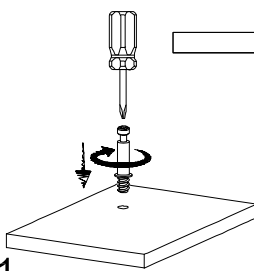

A1

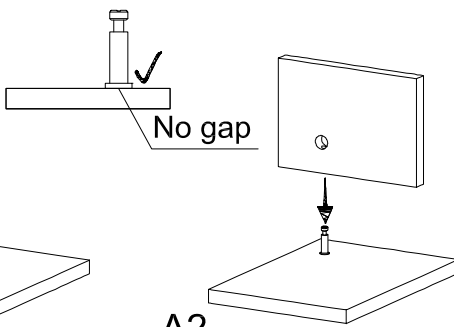

A2

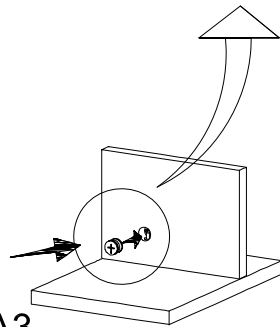



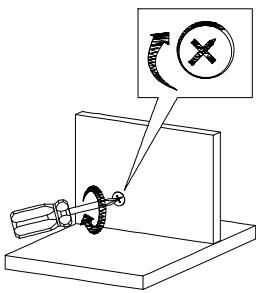



A3

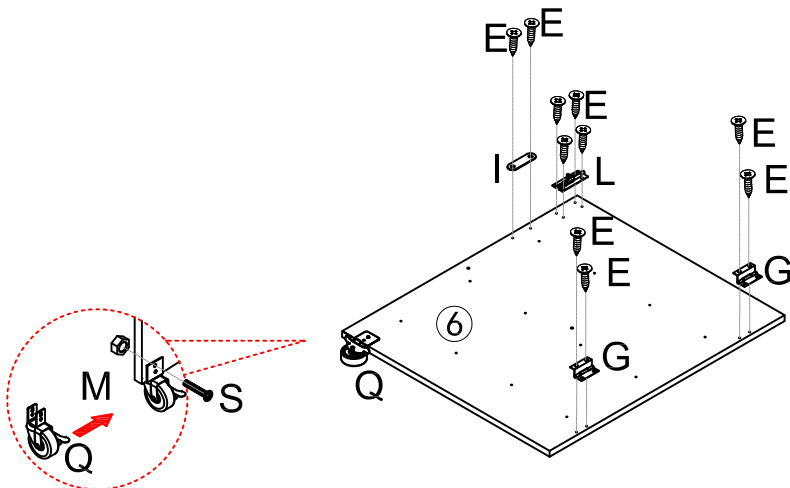

A4

STEP 1



	E*10PCS
	S*1PCS
	Q*1PCS
	I*1PCS
	G*2PCS
	L*1PCS

Assembly Steps

STEP 2

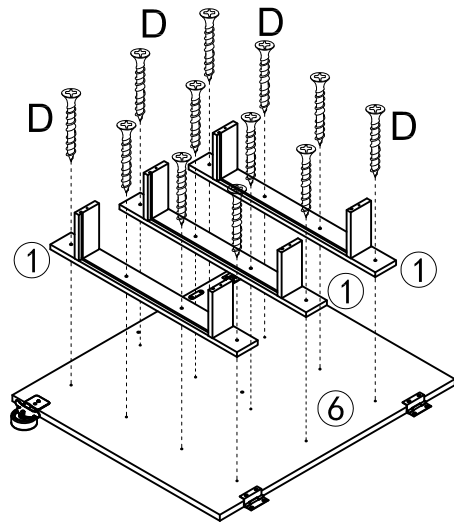
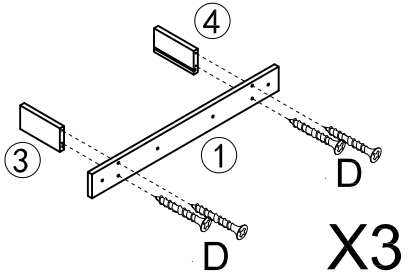

STEP 3

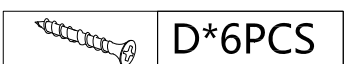
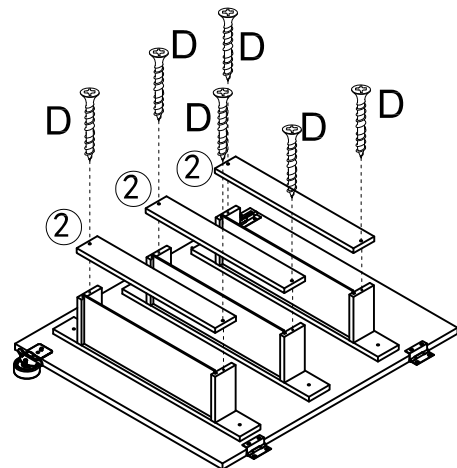
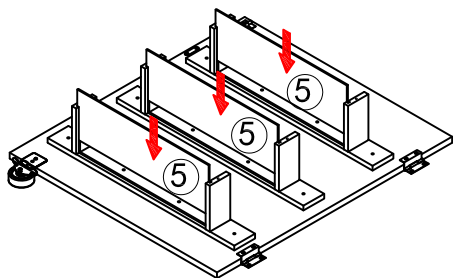

Assembly Steps

STEP 4

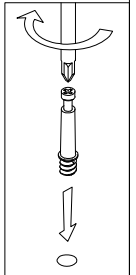
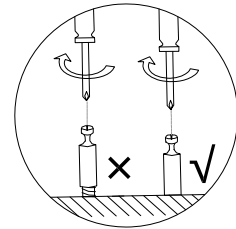
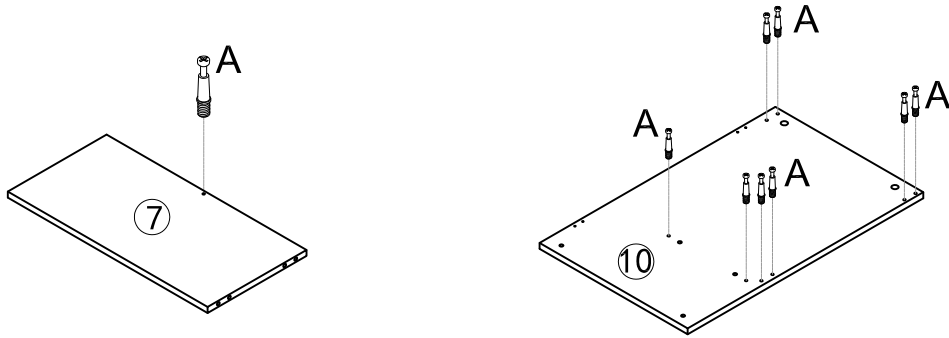

A*9PCS

STEP 5

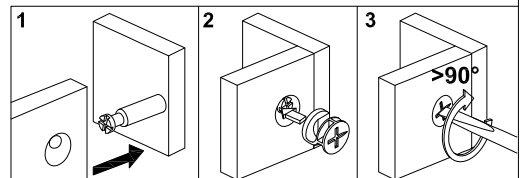
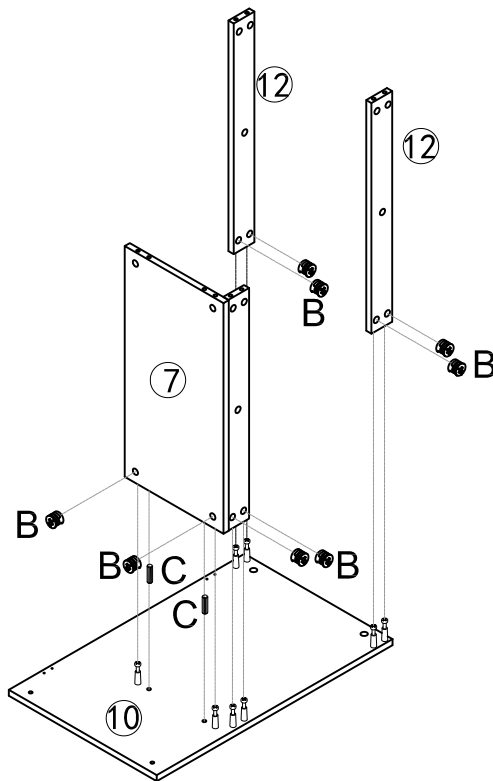
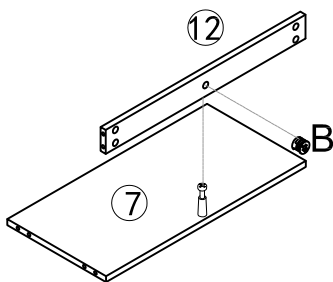

C*2PCS





B*9PCS

Assembly Steps

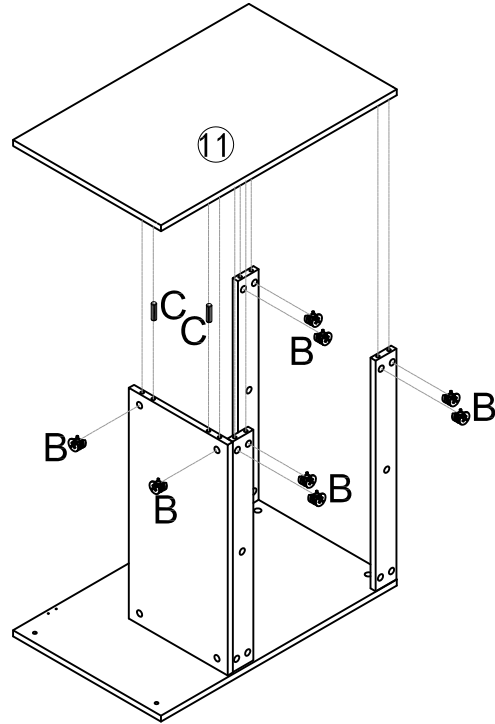
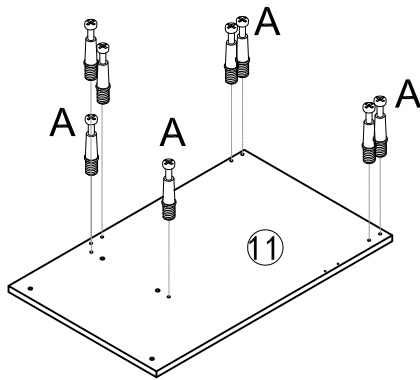
STEP 6



	A*8PCS
	C*2PCS
	B*8PCS

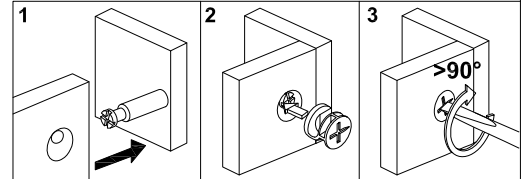

STEP 7

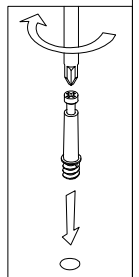
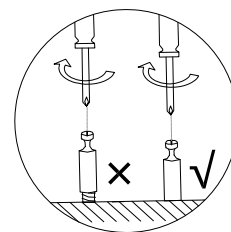
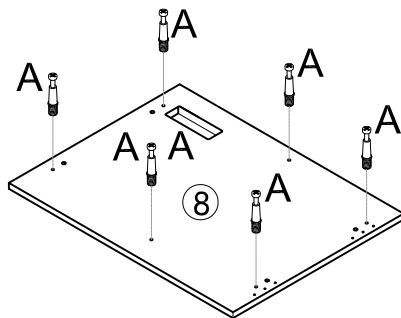



	A*6PCS
---	--------

Assembly Steps

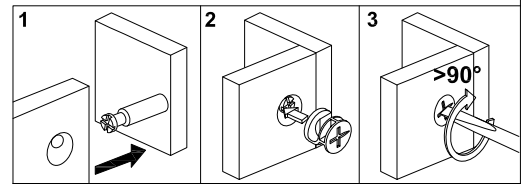
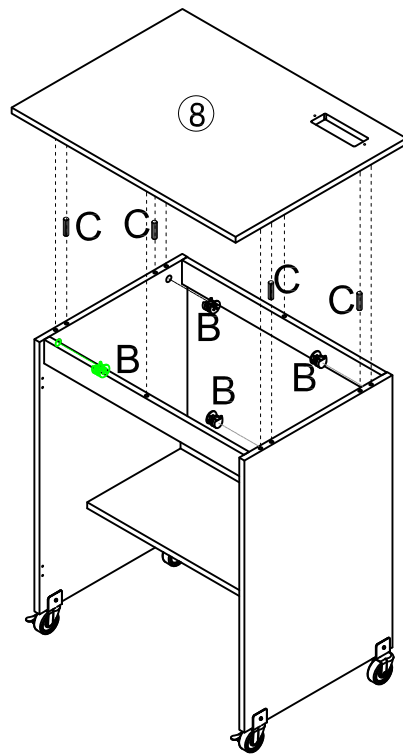





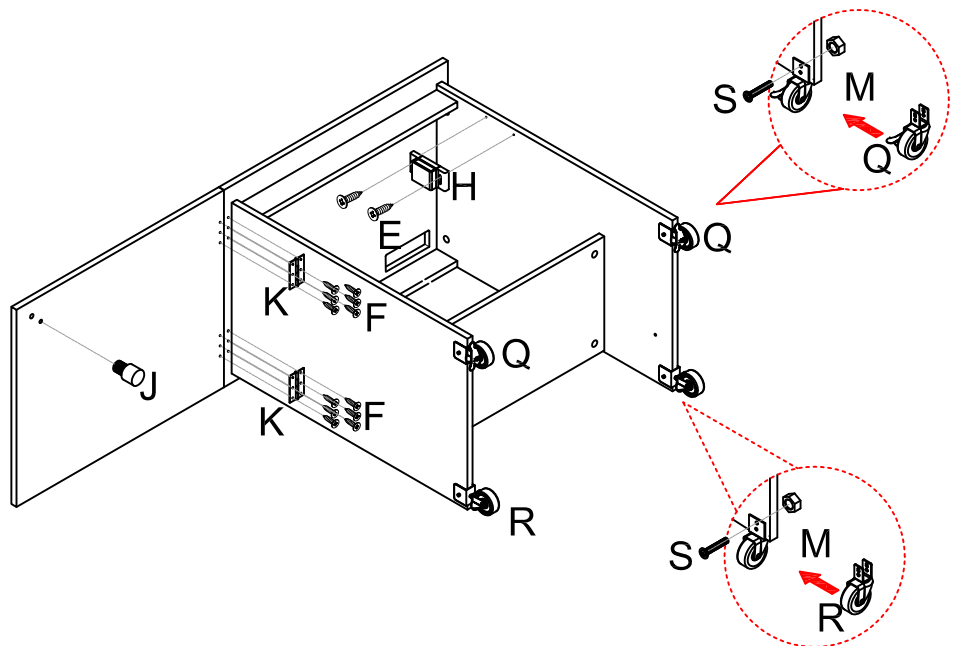

STEP 8



	C*4PCS
	B*6PCS

STEP 9





	F*12PCS
	H*1PCS
	S*5PCS
	R*2PCS
	Q*1PCS
	J*1PCS
	E*2PCS
	K*2PCS

Assembly Steps

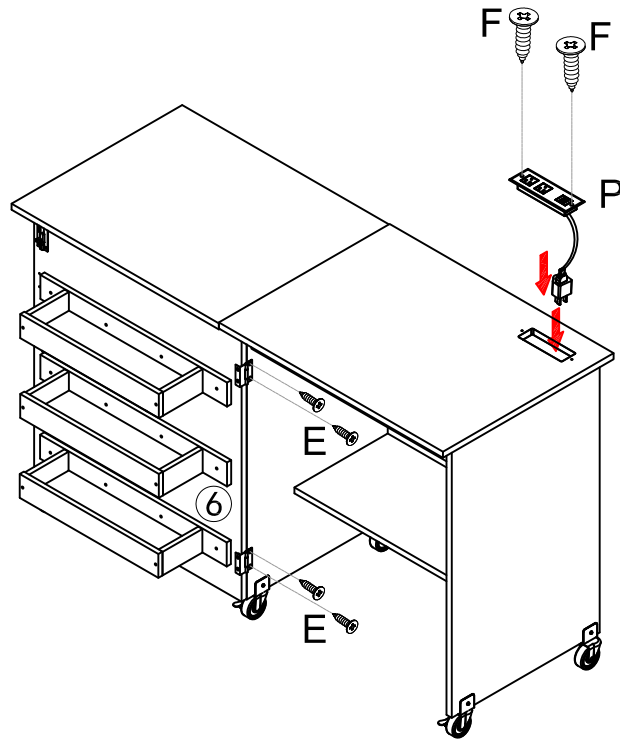

STEP 10

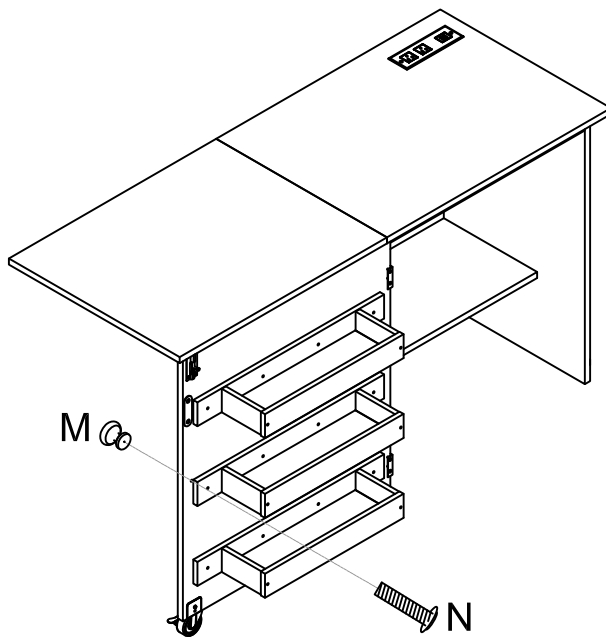

	F*2PCS
	P*1PCS
	E*4PCS

STEP 11



	N*1PCS
	M*1PCS

Assembly Steps

STEP 12

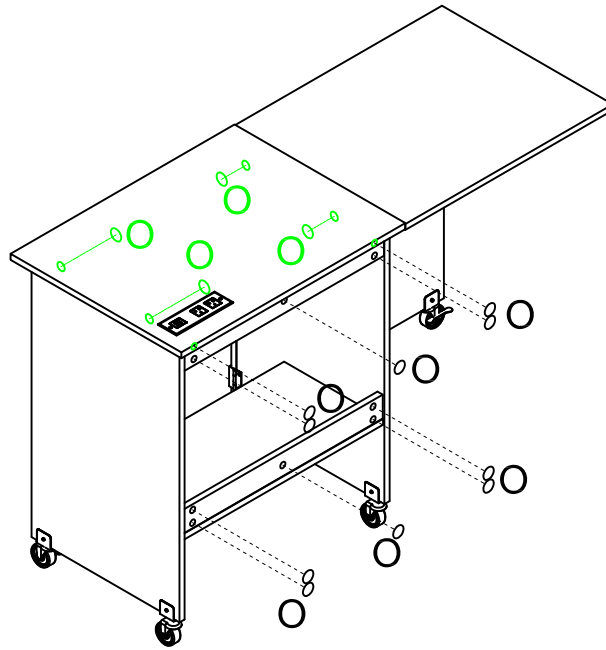

"O" Follow the color and pattern circular sticker, stick it on the screw hole position



O*14PCS

STEP 13

