

ASSEMBLY INSTRUCTIONS

STEP-1

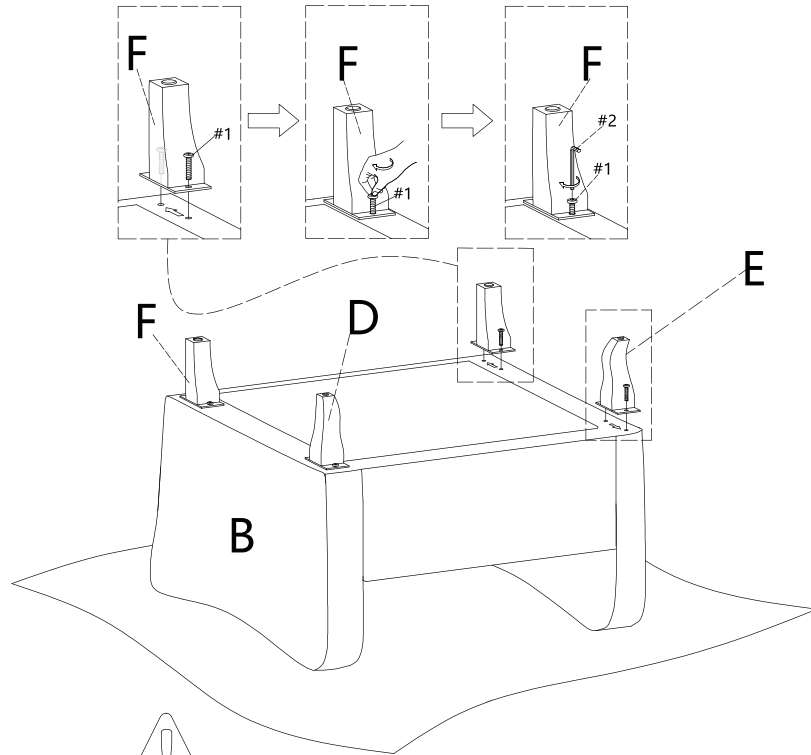

The arrow direction of the legs are the same as the arrow direction at the bottom of the seat!

ASSEMBLY INSTRUCTIONS

STEP-2

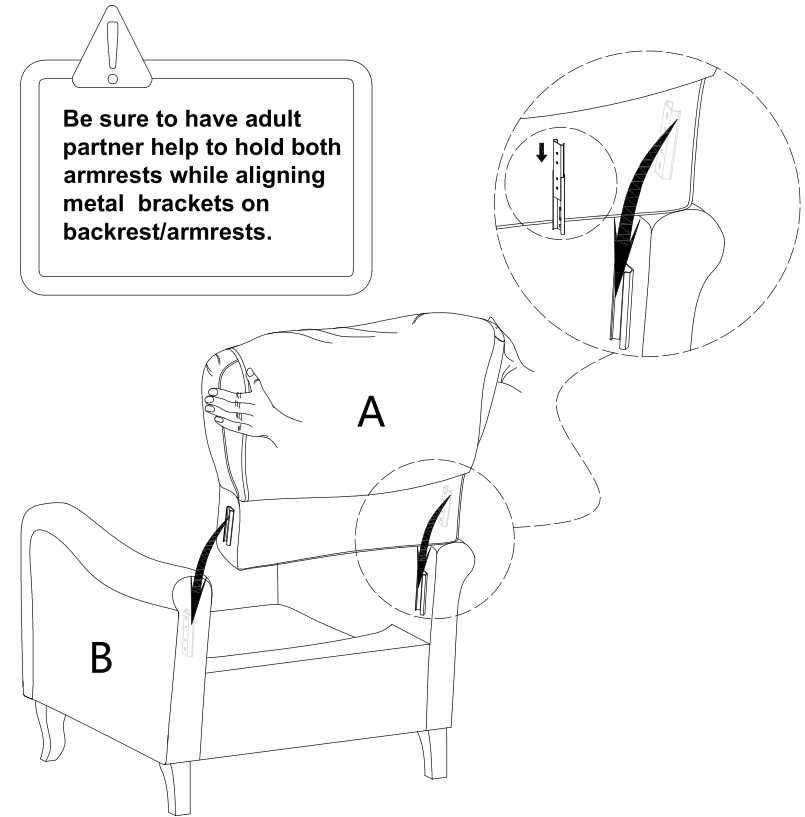

ASSEMBLY INSTRUCTIONS

STEP-3

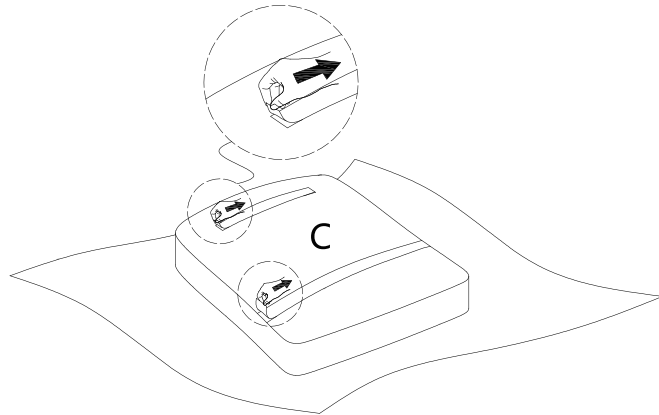

ASSEMBLY INSTRUCTIONS

STEP-4

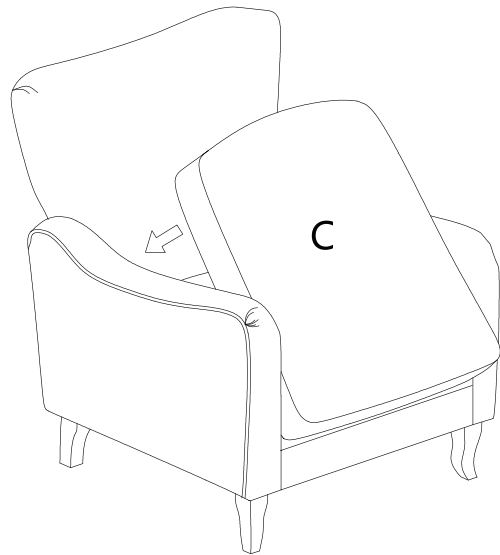

6

PARTS LIST

A	x1	B	x1	C	x1	D	x1
Back		Seat frame		Seat cushion		Front left legs	
E	x1	F	x2				
Front right legs		Rear legs					

1PERSON

HARDWARE LIST

#1	x8
Bolt M8x18mm	

TOOL LIST

#2	x1
Allen Key M6	

HARDWARE SPARE LIST

#1	x1
Bolt M8x18mm	

3

MAINTAINANCE AND WARNING

- 1.Keep furniture away from heat sources.
- 2.Do not clean furniture with harsh cleaner or polishes.Do not use detergents,solvents,abrasives,spray packs or leather cleaner. Use non-color mild soa with warm water to clean spills(Mix 1:10 soap to water).
- 3.Do not place furniture under direct sunlight,material will possibly fade over time.
- 4.Do not use on site dry cleaning machine.Children should not climb or jump on the furniture.
- 5.Do not write on furniture that is not protectedby a padded barrier.
- 6.Not for commercial use,only for residential use.



ASSEMBLY INSTRUCTIONS

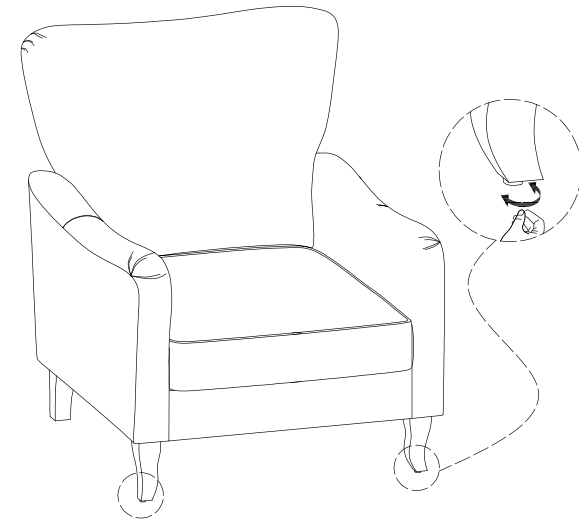
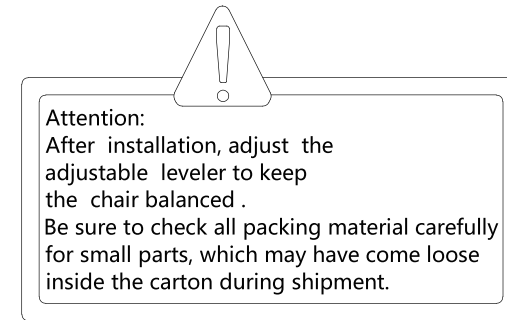

WARRANTY

1. We strive to offer high-quality products, and we also try our best to satisfy each and every customer that orders from us with product or service as needed.
2. We provide 30 days warranty starting from the time you receive the item. Each customer must provide a record of their order such as the order number, or item receipt for any items that are out of the warranty period you may also still receive.
3. Replacement parts by purchasing them with our company if they are available.

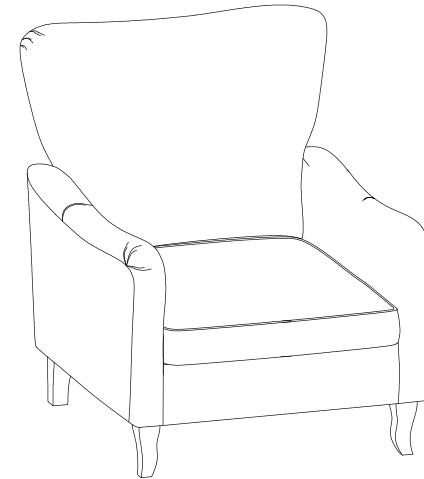

NOTE:

This brochure contains IMPORTANT safety info. Please read and keep for future reference.
