

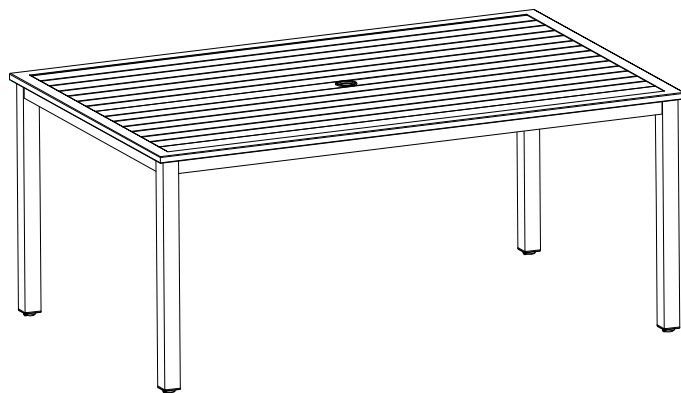

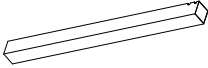

Outdoor Dining Table

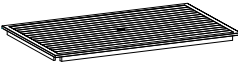

PART LIST

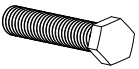
<div data-bbox="60 159 97 197" data-label="Text">#A</div> 	<div data-bbox="331 159 368 197" data-label="Text">#B</div> 
<div data-bbox="151 405 252 472" data-label="Text"> <p>Leg 4 PCS</p> </div>	<div data-bbox="379 405 528 472" data-label="Text"> <p>Top Panel 1 PC</p> </div>

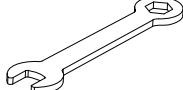
HARDWARE LIST

<div data-bbox="60 649 97 687" data-label="Text">#1</div>  <div data-bbox="113 835 268 869" data-label="Text"> <p>M8*35mm</p> </div>	<div data-bbox="331 649 368 687" data-label="Text">#2</div>  <div data-bbox="395 835 499 869" data-label="Text"> <p>M6mm</p> </div>	<div data-bbox="593 649 630 687" data-label="Text">#3</div> 	<div data-bbox="855 649 892 687" data-label="Text">#4</div> 
<div data-bbox="84 891 316 967" data-label="Text"> <p>Bolt 8 PCS (Extra 1)</p> </div>	<div data-bbox="347 891 579 967" data-label="Text"> <p>Flat Washer 8 PCS (Extra 1)</p> </div>	<div data-bbox="667 891 786 967" data-label="Text"> <p>Wrench 1 PC</p> </div>	<div data-bbox="946 891 1026 967" data-label="Text"> <p>Cap 1 PC</p> </div>

Step 1. Lay top panel (part B) upside down on a soft flat surface, such as carpet, as shown below. Attach legs (part A) to top panel (part B) using bolts (part #1), flat washers (part #2) and wrench (part #3).

NOTE: Please fully tighten all bolts at this time.

NOTE: It is important to adjust levelers once fully assembled and upright. Extend adjustable leveler until it's firmly in contact with the floor. If relocating, adjust leveler as needed until it's firmly in contact with the floor in new location.

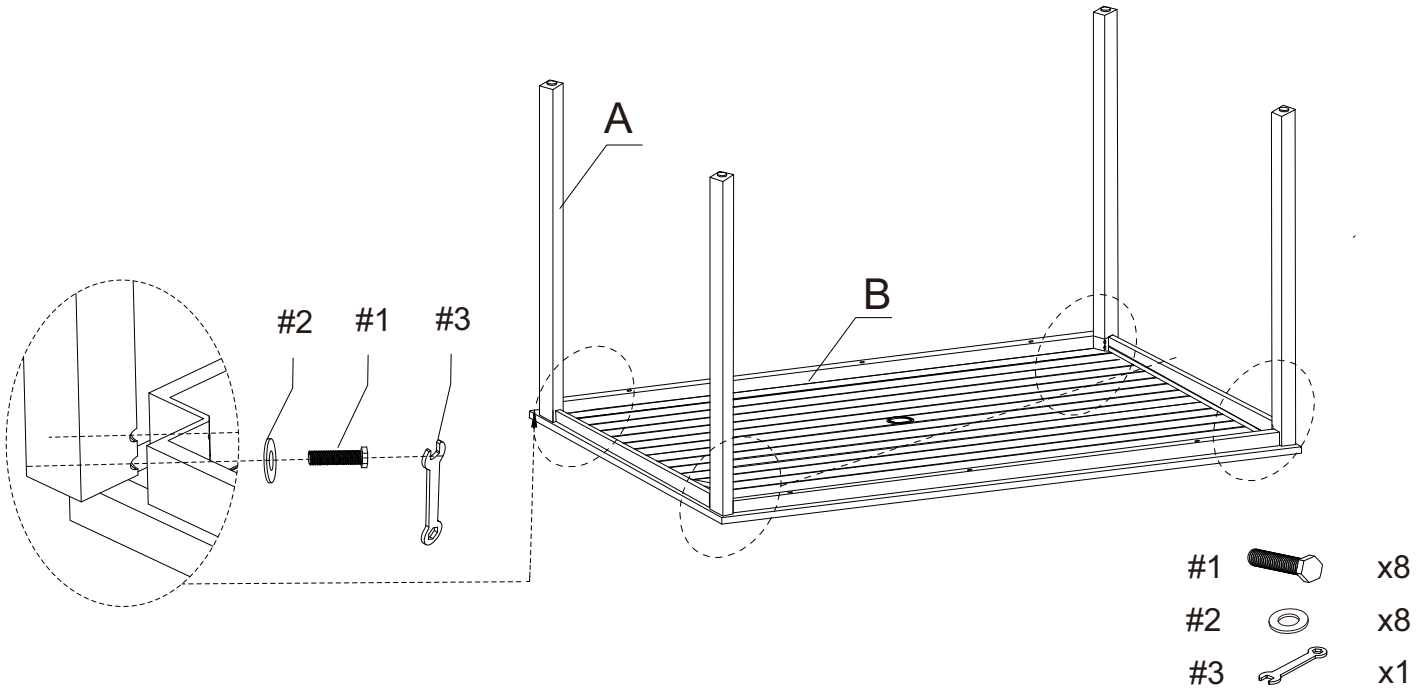

Step 2. Carefully turn unit upright. Attach cap (part #4) to top panel (part B).

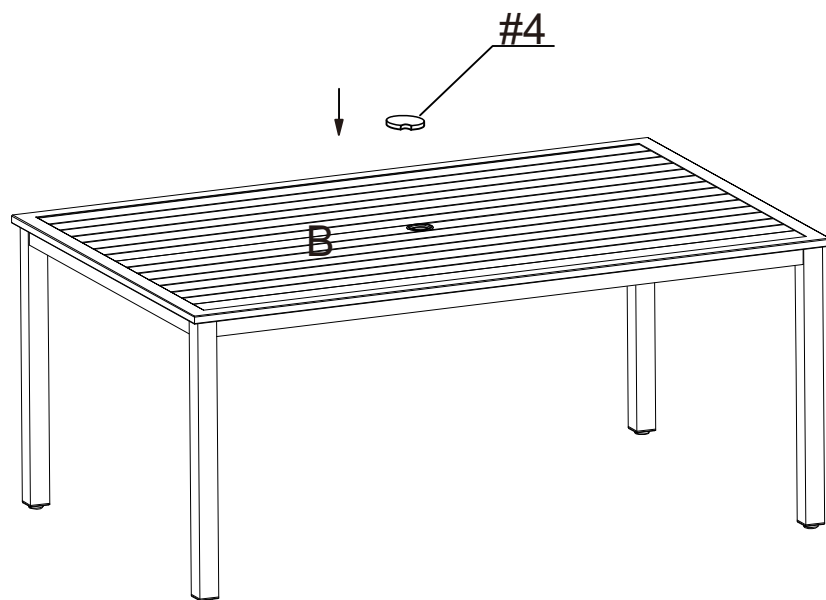

#4		x1
----	---	----