

ASSEMBLY INSTRUCTION

MF320570

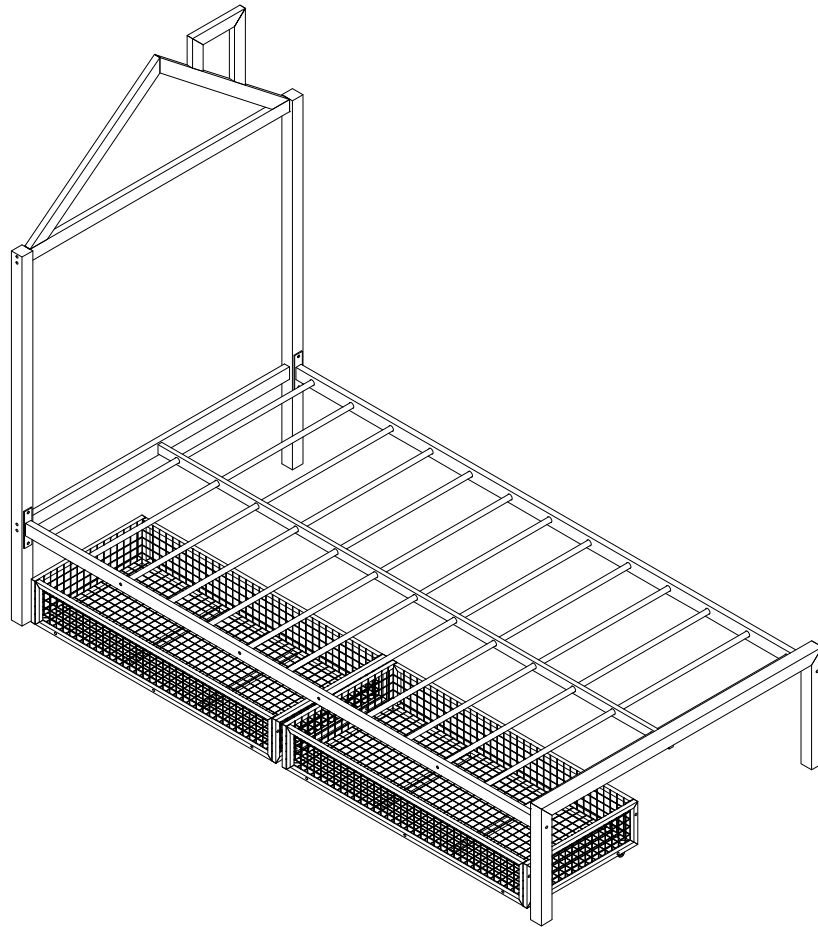

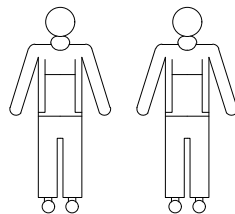

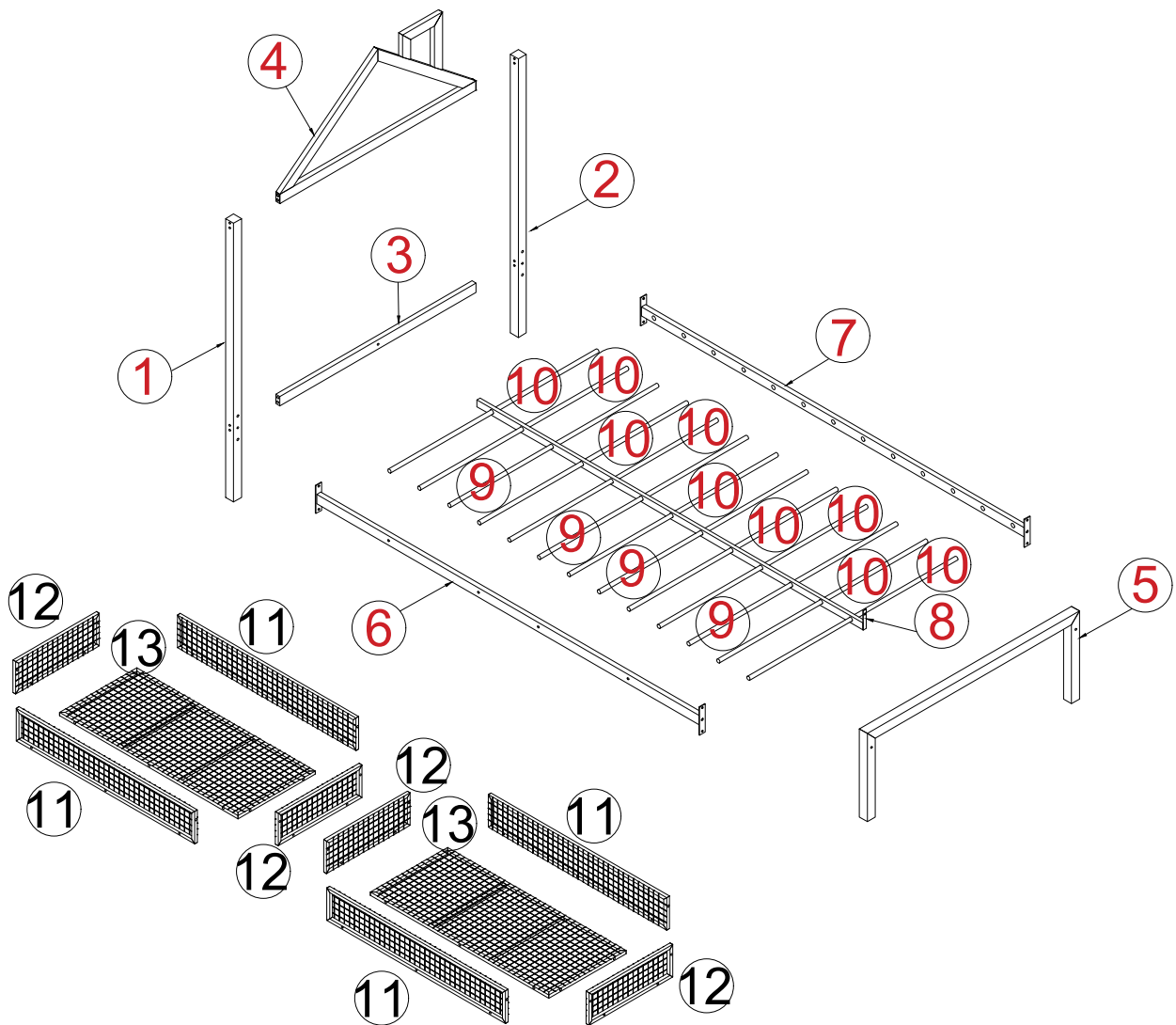

Minimum no. 2 of people
recommended to assemble
this product: Approx.
assembly time: 60 mins





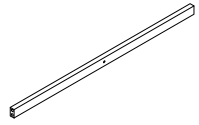
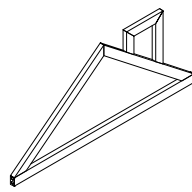
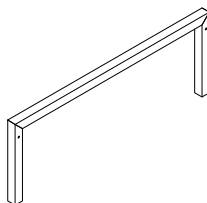
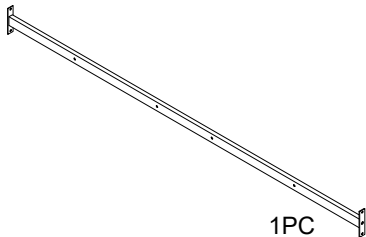
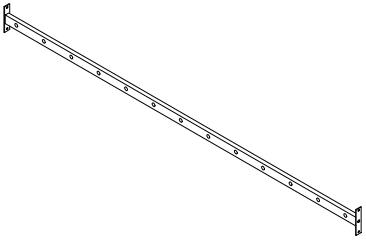
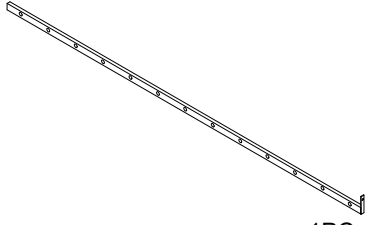
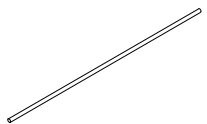
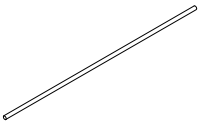
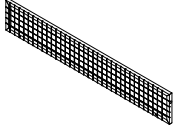

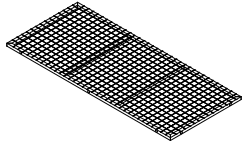



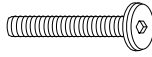
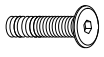

PART LIST MF320570

| | | |
|---|---|---|
| <p>1</p>  <p>1PC</p> | <p>2</p>  <p>1PC</p> | <p>3</p>  <p>1PC</p> |
| <p>4</p>  <p>1PC</p> | <p>5</p>  <p>1PC</p> | <p>6</p>  <p>1PC</p> |
| <p>7</p>  <p>1PC</p> | <p>8</p>  <p>1PC</p> | <p>9</p>  <p>4PCS</p> |
| <p>10</p>  <p>9PCS</p> | <p>11</p>  <p>4PCS</p> | <p>12</p>  <p>4PCS</p> |
| <p>13</p>  <p>2PCS</p> | | |

HARDWARE LIST MF320570

| | | | |
|---|---|--|---|
| <p>A</p>  <p>12PCS M$\frac{1}{4}$"X55</p> | <p>B</p>  <p>1PC M$\frac{1}{4}$"X35</p> | <p>C</p>  <p>28PCS M$\frac{1}{4}$"X25</p> | <p>D</p>  <p>17PCS M$\frac{1}{4}$"X15</p> |
| <p>E</p>  <p>4PCS #40x40x16</p> | <p>F</p>  <p>15x20x40H 8 PCS</p> | <p>G</p>  <p>M4x15 16 PCS</p> | <p>H</p>  <p>1PC M4X23X57</p> |

STEP 1

| | |
|---|---|
| A | E |
|  |  |
| M $\frac{1}{4}$ 'x55 | #40x40x16 |
| 8 PCS | 2 PCS |

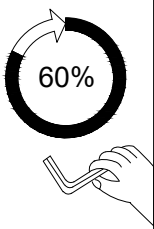
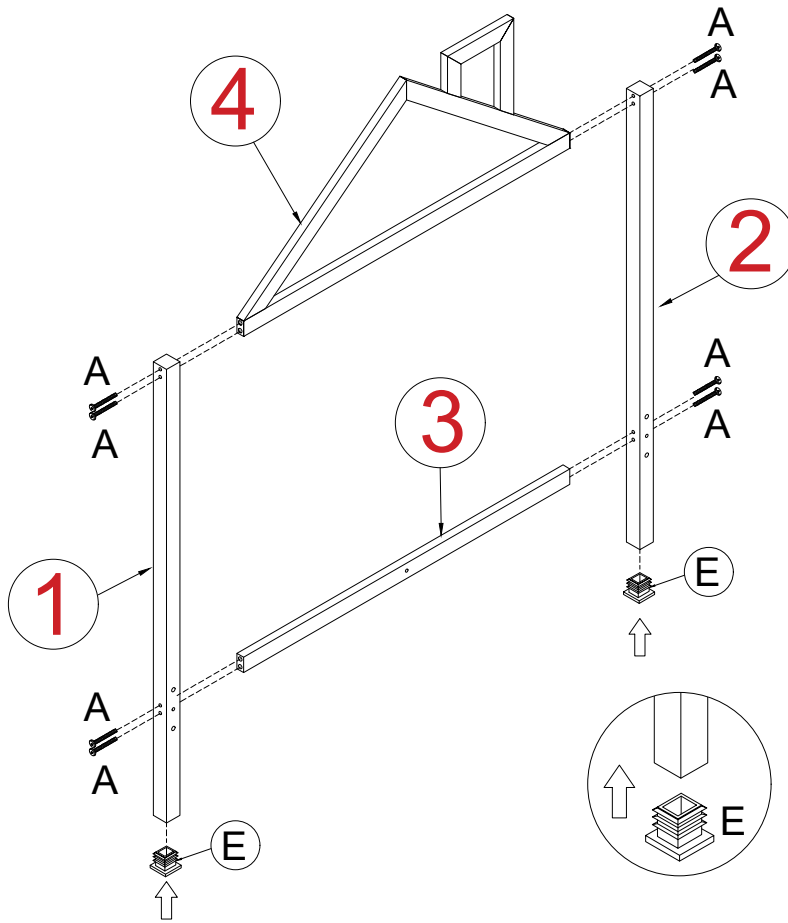



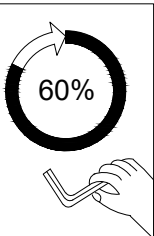
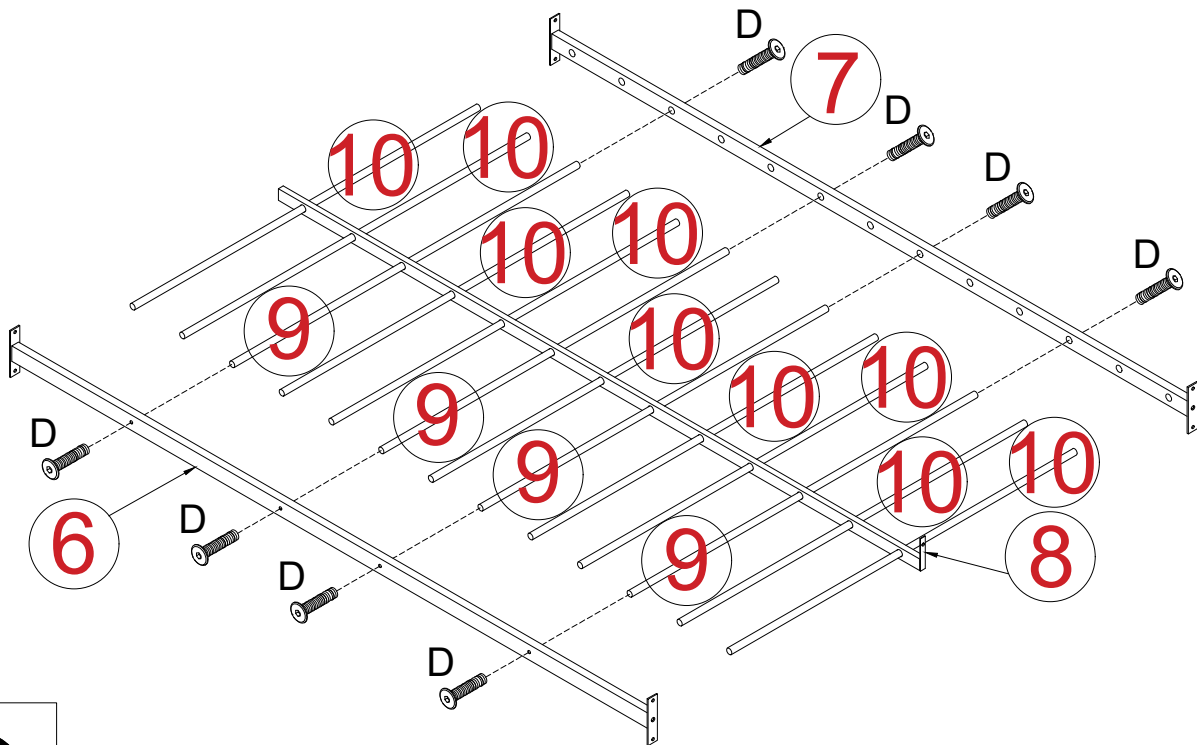

STEP 2

| |
|---|
| D |
|  |
| M $\frac{1}{4}$ 'x15 |
| 8 PCS |



STEP 3

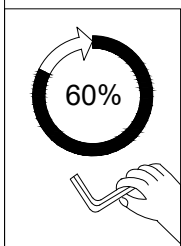
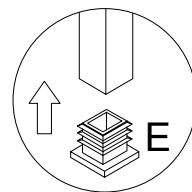
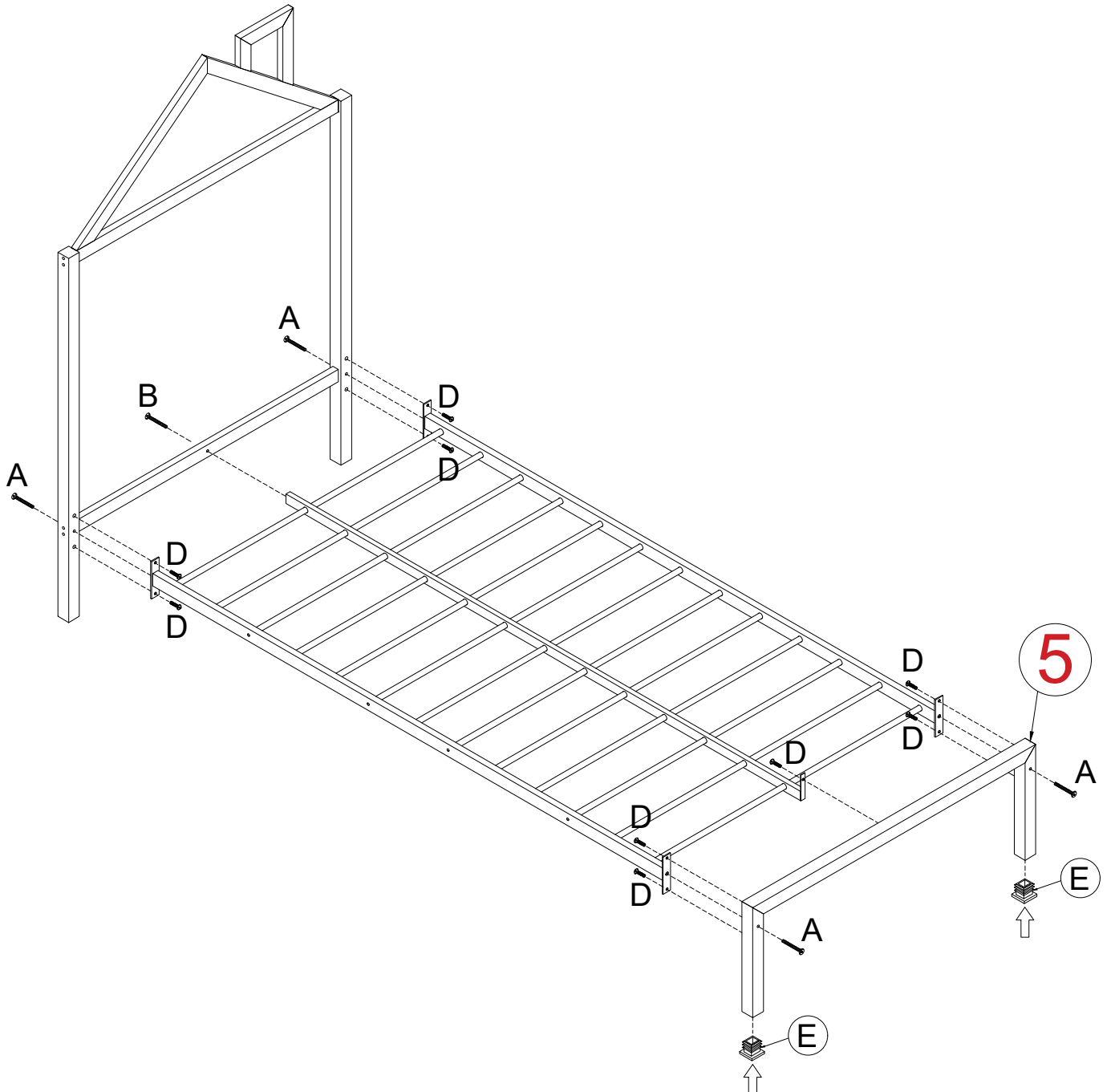

| A | B | D | E |
|--|---|---|---|
|  |  |  |  |
| M $\frac{1}{4}$ "x55 | M $\frac{1}{4}$ "x35 | M $\frac{1}{4}$ "x15 | #40x40x16 |
| 4 PCS | 1 PC | 9 PCS | 2 PCS |

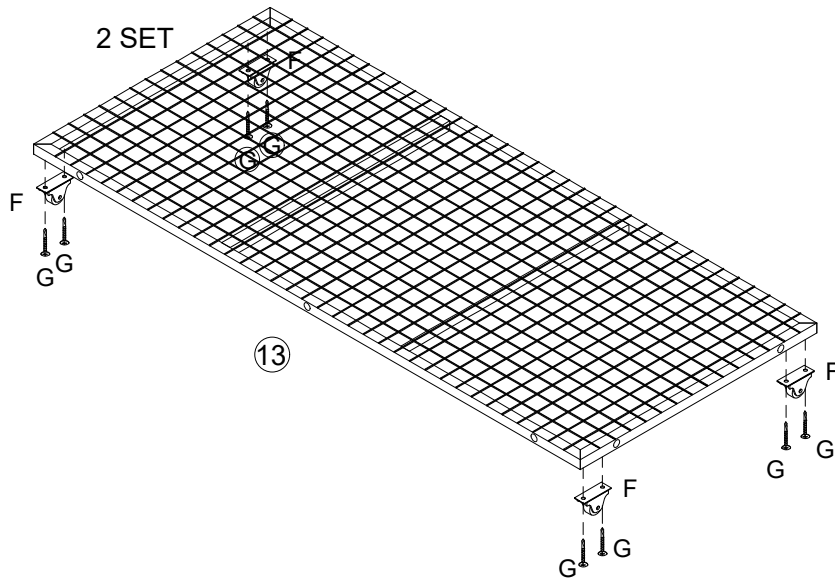

STEP 4

2 SET



| | |
|---|---|
| F | G |
|  15x20x40H |  M4x15 |
| 8 PCS | 16 PCS |

STEP 5

2 SET

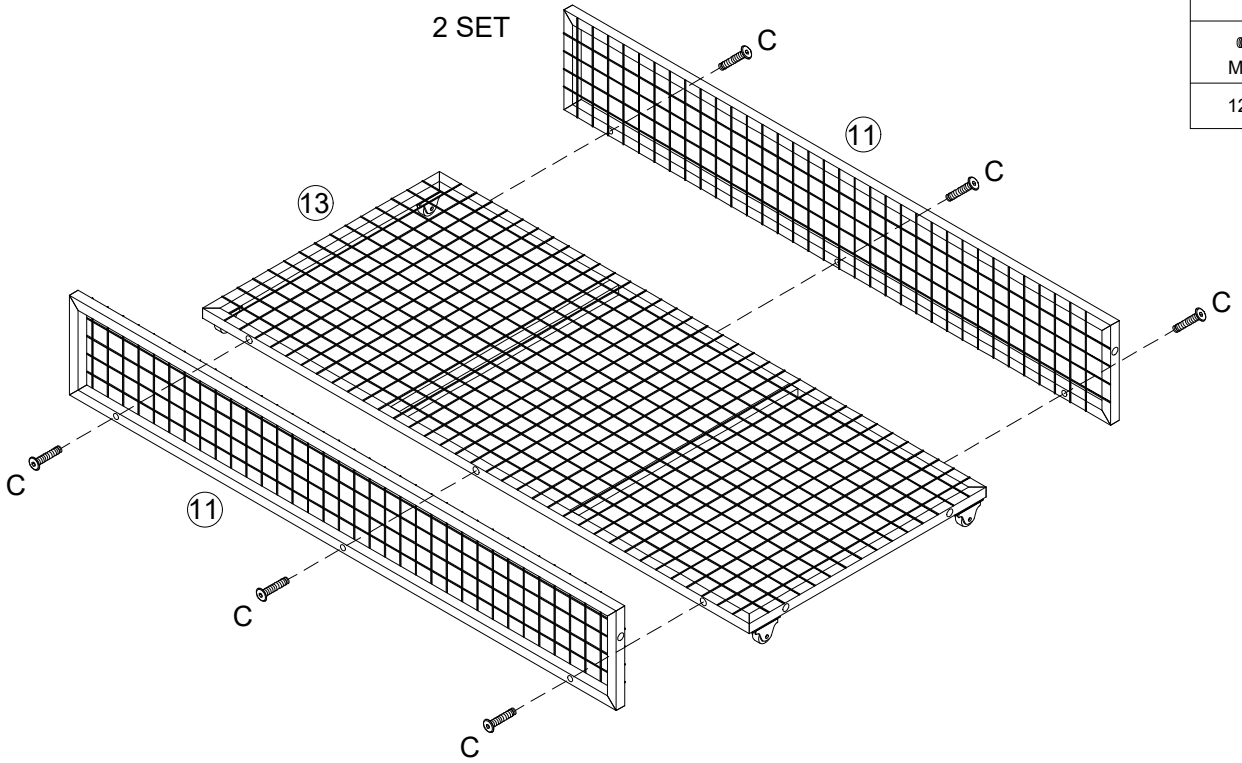

| |
|--|
| C |
|  M $\frac{1}{2}$ X25 |
| 12 PCS |

STEP 6

2 SET

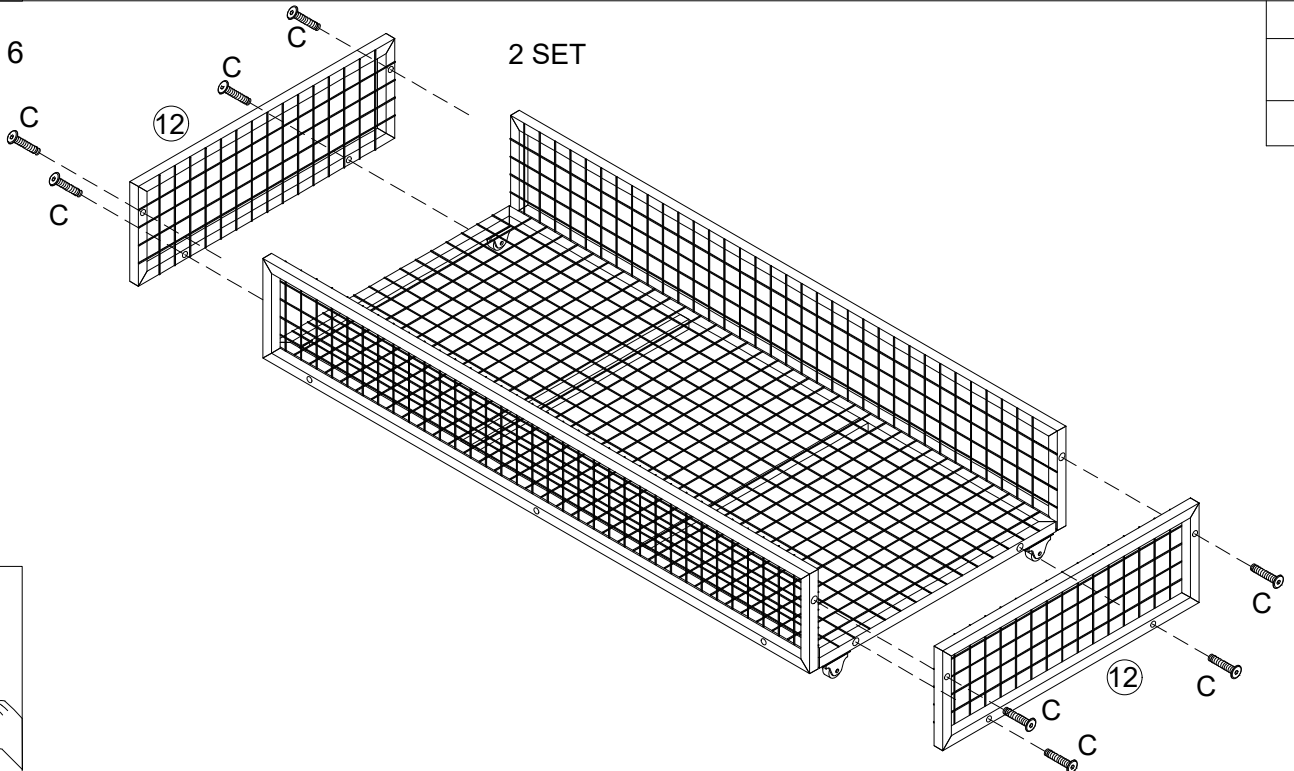

| |
|--|
| C |
|  M $\frac{1}{2}$ X25 |
| 16 PCS |

STEP 7

