

Pure & Easy



# **ASSEMBLY INSTRUCTIONS**

# NOTICE

IMPORTANT, RETAIN FOR FUTURE REFERENCE: READ CAREFULLY  
WICHTIG, FÜR SPÄTERE NACHSCHLAGE AUFBEWAHREN: SORGFÄLTIG LESEN  
IMPORTANTE, GUARDAR PARA REFERENCIA FUTURA: LEER ATENTAMENTE  
IMPORTANTE, CONSERVARE PER RIFERIMENTI FUTURI: LEGGERE ATTENTAMENTE  
IMPORTANT, À CONSERVER POUR RÉFÉRENCE FUTURE : LIRE ATTENTIVEMENT

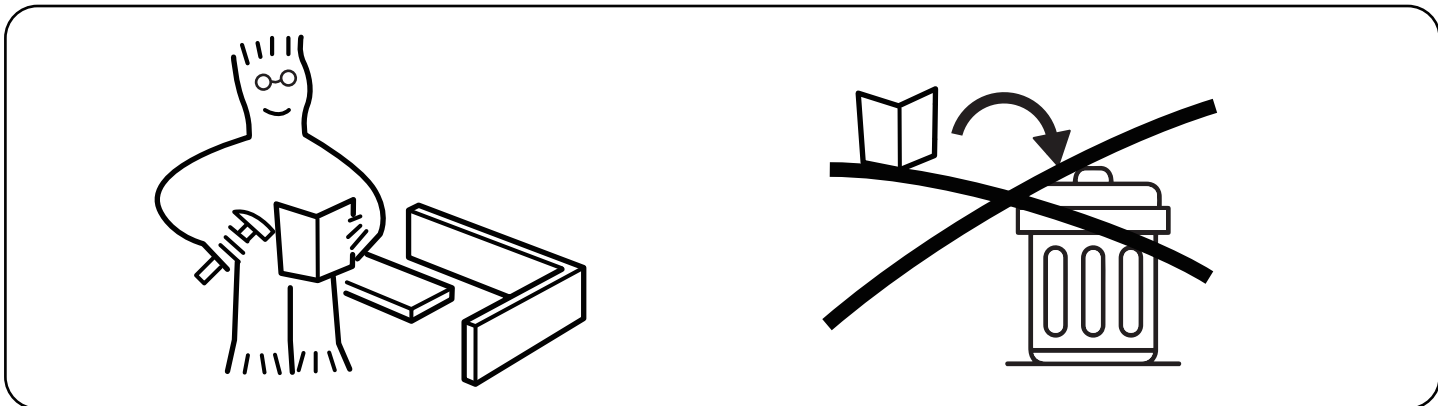

Assemble on a flat and solid surface. To avoid the unstable surface affecting the overall frame stability during installation.

Montieren Sie auf einer ebenen und festen Oberfläche. Um zu verhindern, dass eine unebene Oberfläche während der Montage die Gesamtrahmen-Stabilität beeinträchtigt.

Ensamblar en una superficie plana y sólida. Afin d'éviter que la surface inégale n'affecte la stabilité générale du cadre lors de l'installation.

Assemblare su una superficie piana e solida. Per evitare che una superficie irregolare influisca sulla stabilità complessiva della struttura durante l'installazione.

Assemble sur une surface plate et solide. Para evitar que la instalación en una superficie irregular afecte la estabilidad general del marco.

Professional installation is highly recommended.  
Eine professionelle Installation wird dringend empfohlen.  
Une installation professionnelle est fortement recommandée.  
Si raccomanda vivamente l'installazione professionale.  
Se recomienda altamente la instalación profesional.



Periodically Check That All Components Are Tightly Secured.  
Überprüfen Sie Regelmäßig, Dass Alle Komponenten Fest Gesichert Sind.  
Vérifiez Périodiquement Que Tous Les Composants Sont Bien Fixés.  
Controllare Periodicamente Che Tutti I Componenti Siano Ben Fissati.  
Verifique Periódicamente Que Todos Los Componentes Estén Bien Asegurados.

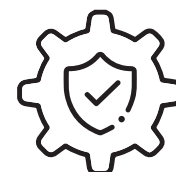

It is recommended that multiple people assemble this product.  
Es wird empfohlen, dass mehrere Personen dieses Produkt zusammenbauen.  
Il est recommandé que plusieurs personnes assemblent ce produit.  
Si raccomanda che più persone assemblino questo prodotto.  
Se recomienda que varias personas ensamblen este producto.

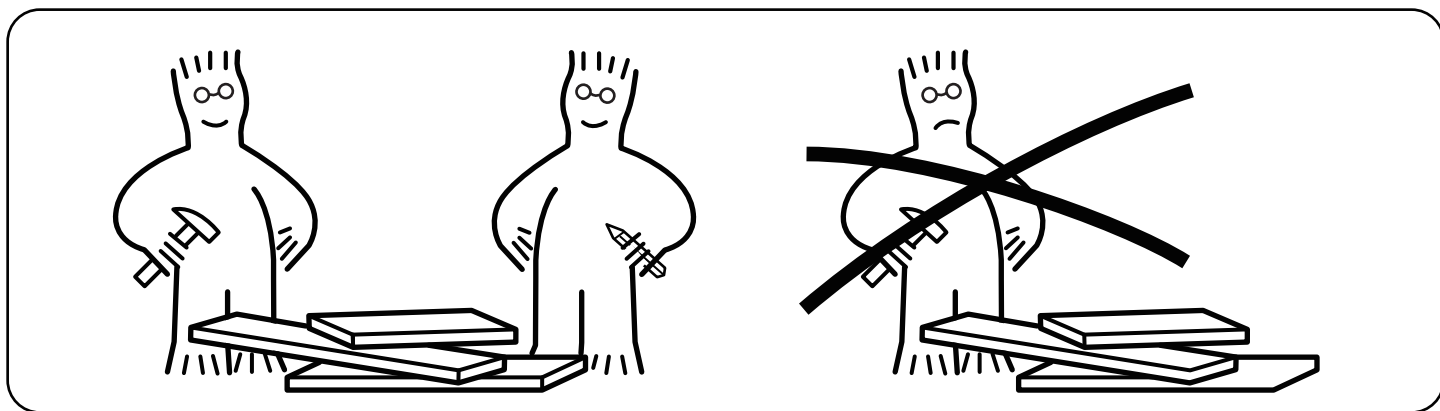



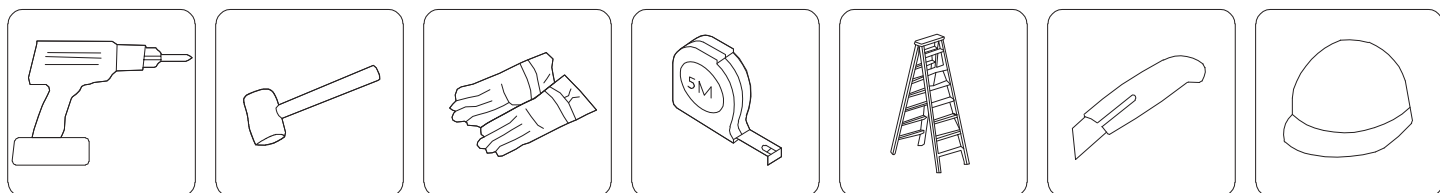







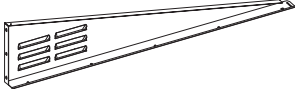
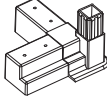
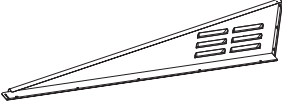



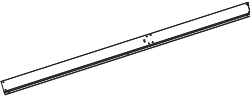

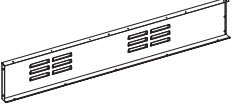
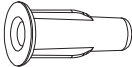
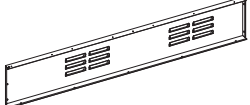

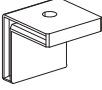
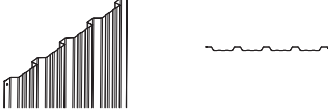

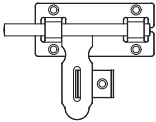
Please have the following auxiliary tools ready:

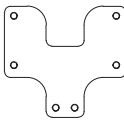

# PARTS

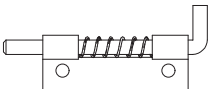
Item no.	Reference Image	Qty.	Item no.	Reference Image	Qty.
1L		X1	7		X2
1		X1	8L		X1
1R		X 1	8R		X1
2		X2	10		X3
3L		X1	15		X4
3R		X1	16		X2
4B		X3	17L		X1
5		X4	17R		X1
6L		X1	19L		X2
6		X1	19R		X2
6R		X1	20		X2

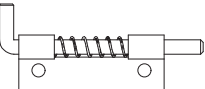
Item no.	Reference Image	Qty.	Item no.	Reference Image	Qty.
21		X4	M1		X2
21L		X1	C		X4
21R		X1	F		X4
22		X1	F4		X4
23		X1	F7		X68
24L		X1	F8		X52
24R		X1	F9		X2
W3		X4	F10		X2
W5		X8	S1		X1
W7		X4	S2		X1
W12		X8	S3		X1

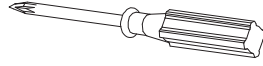
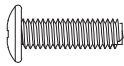
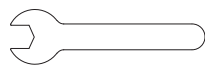
Item no.	Reference Image	Qty.	Item no.	Reference Image	Qty.
S4	 M4 X 10mm	X256	S7	 M4	X59
S5L		X1	S8	 M5 X 16mm	X6
S5R		X1	S9		X4
S6	 M4 X 8mm	X55	S12		X1
S6A		X10	S15		X1

# EXPLODED VIEW

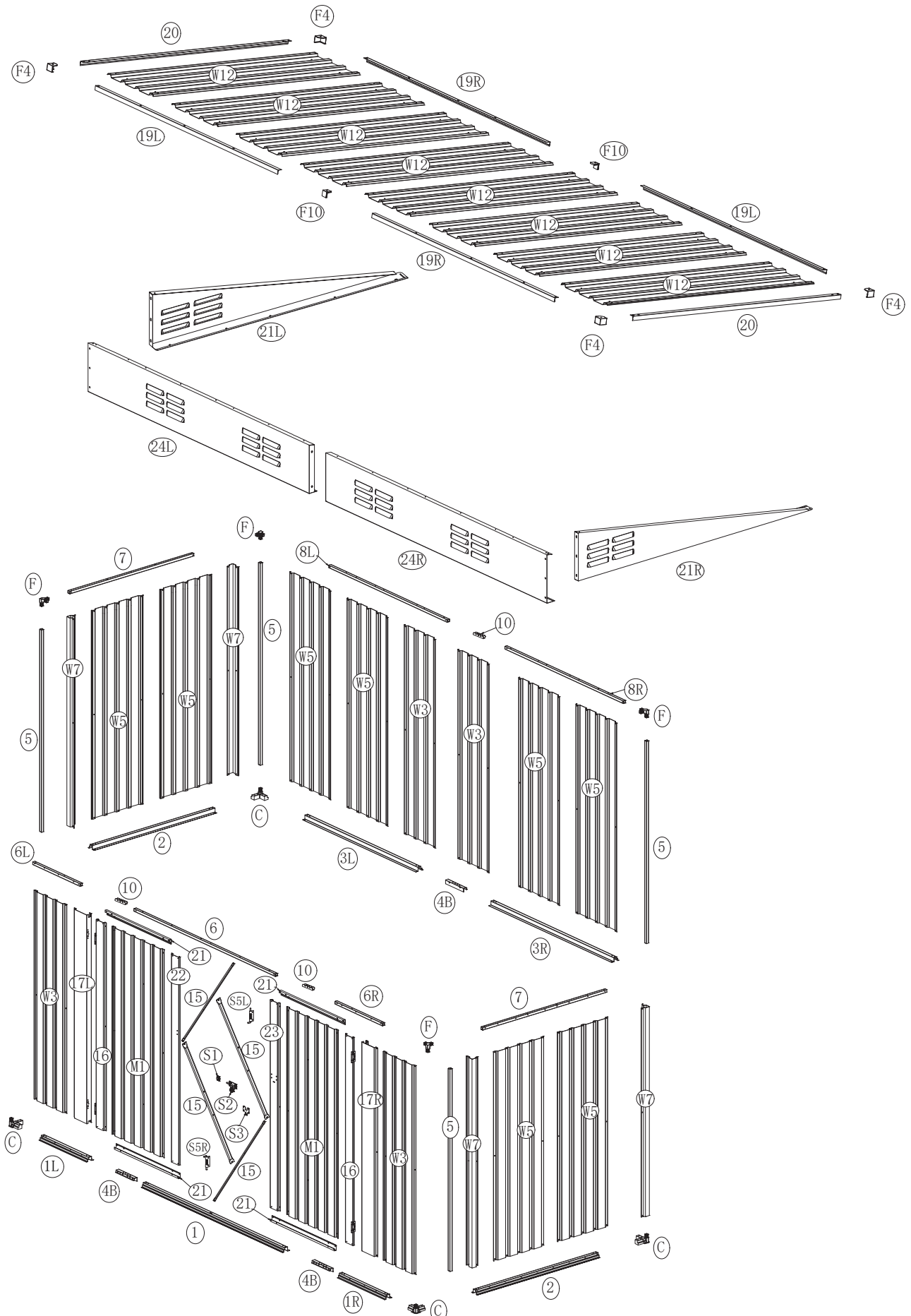

# ASSEMBLY

# 1



①L 1pc



① 1pc



①R 1pc



④B 2pcs



⑤S4 8pcs

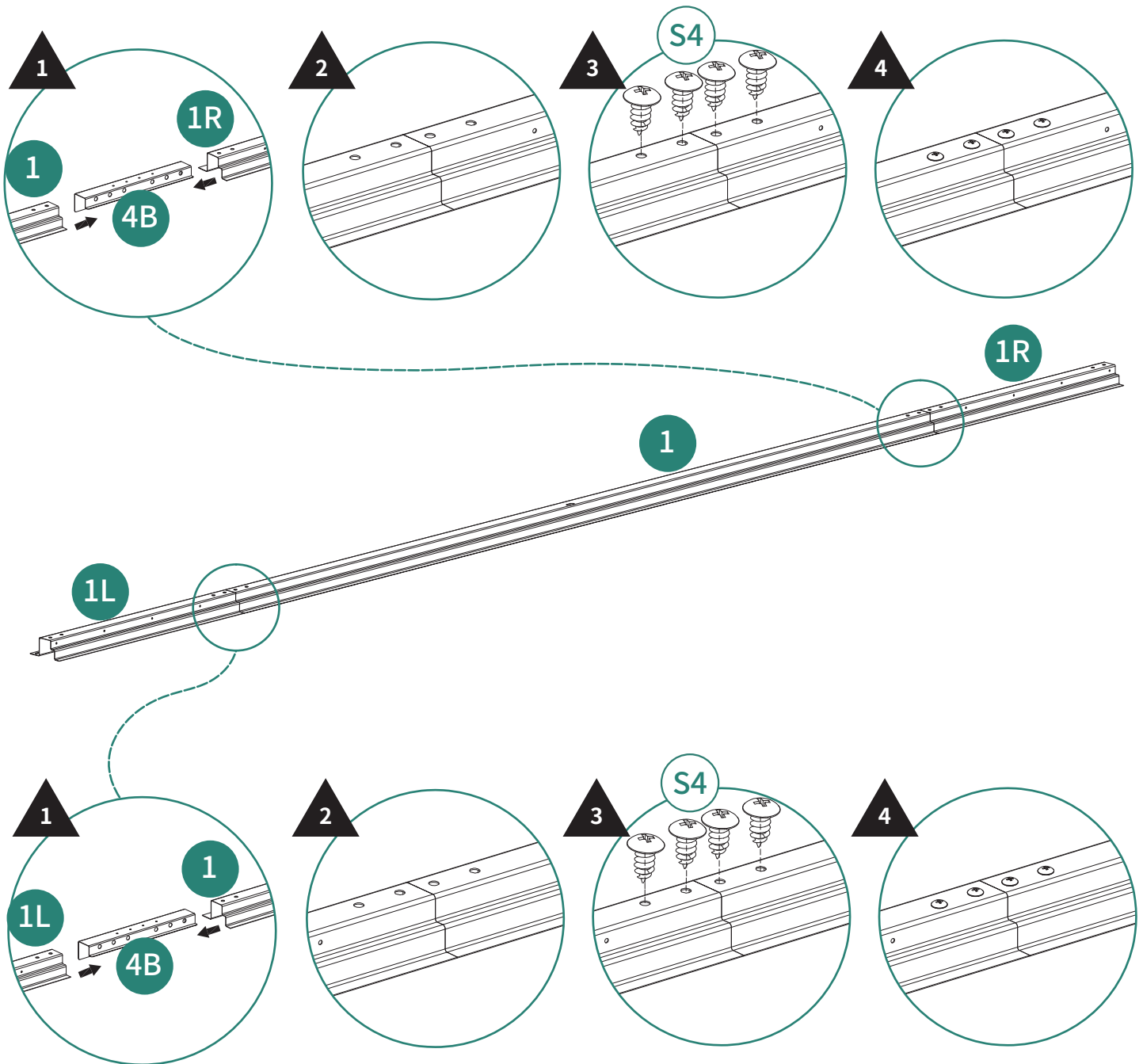

2



3L 1pc



3R 1pc

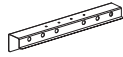

4B 1pc



S4 4pcs

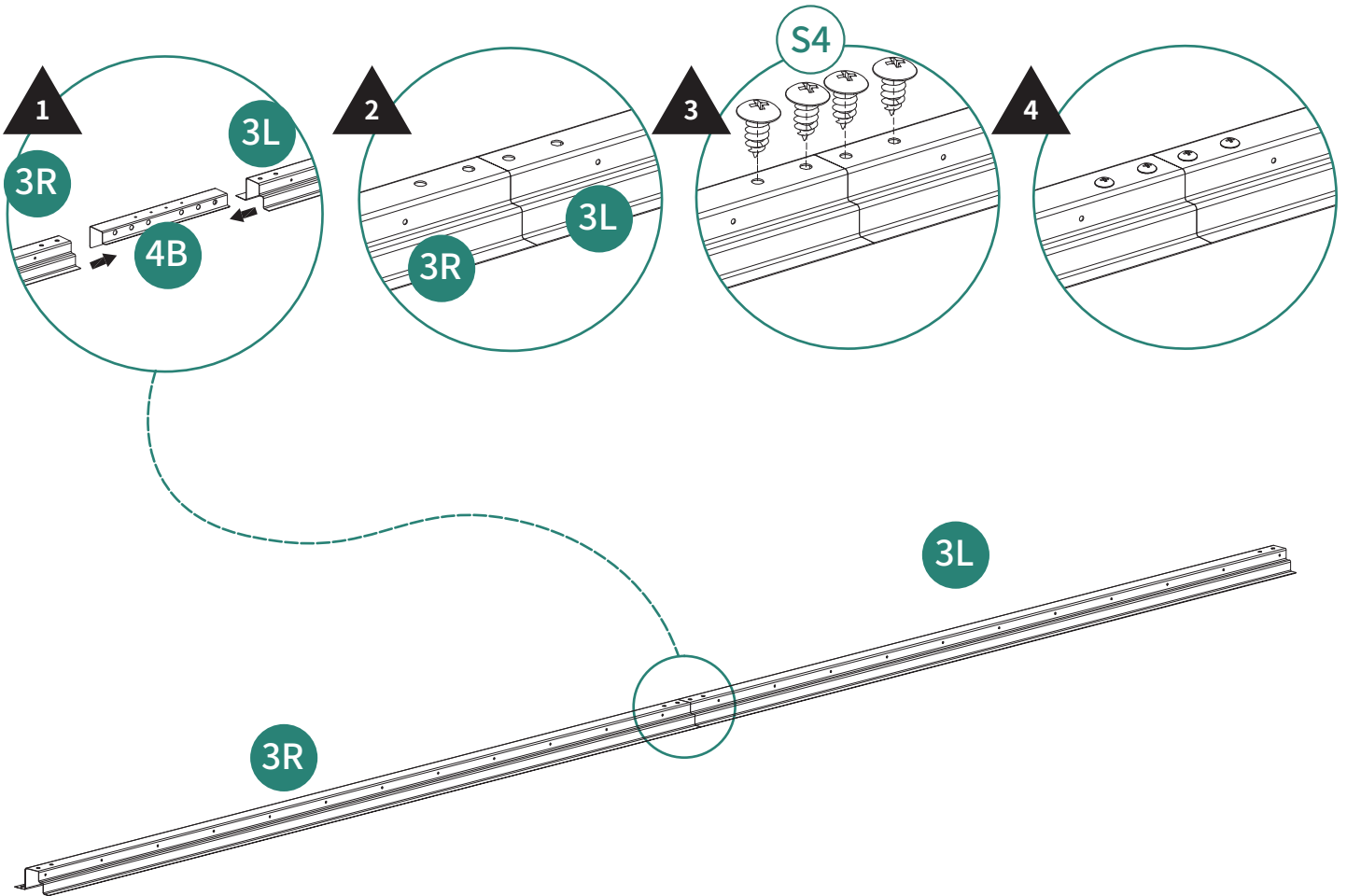

# 3



② 2pcs

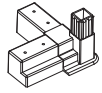

④ 4pcs



④ S4 16pcs

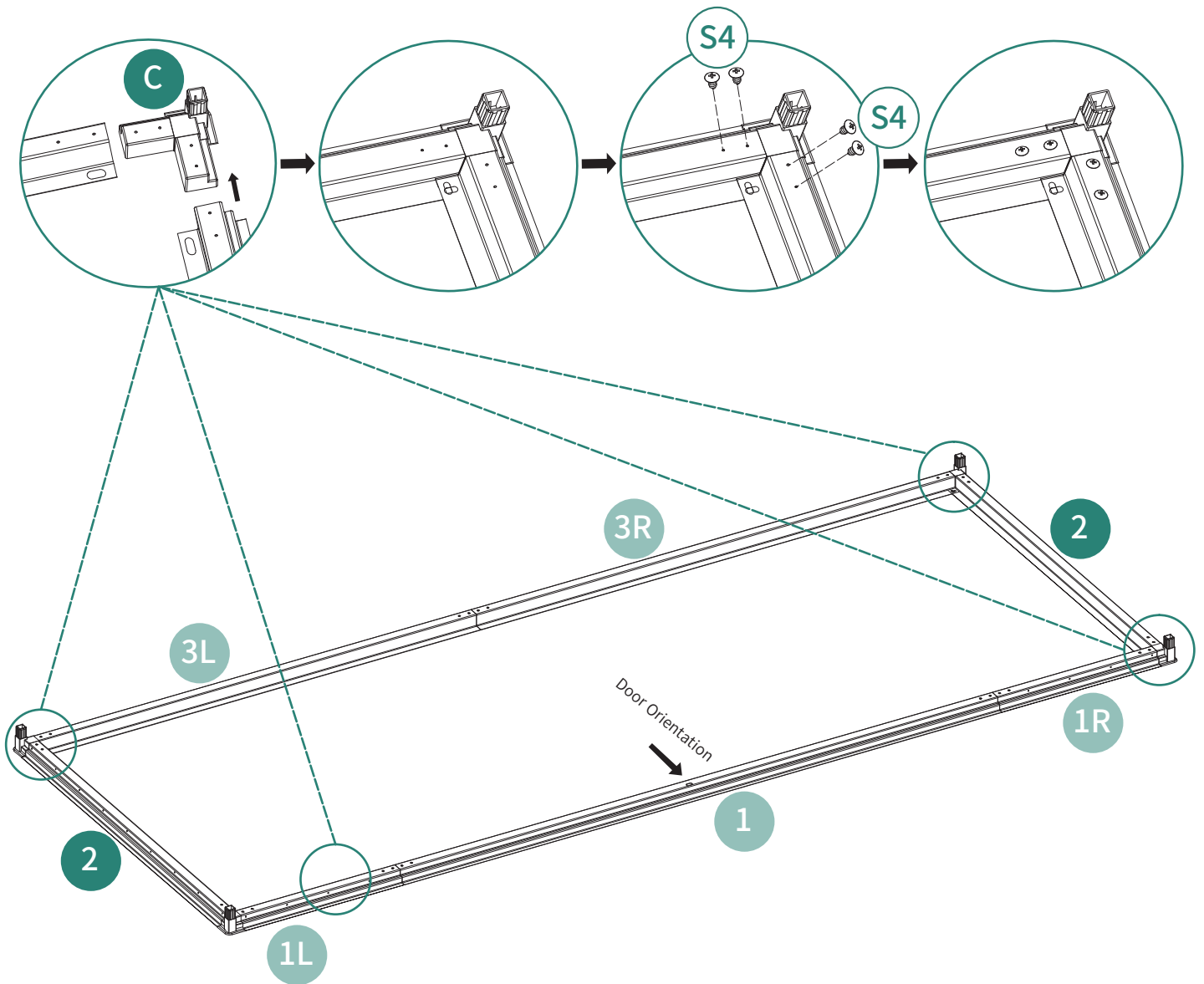





4

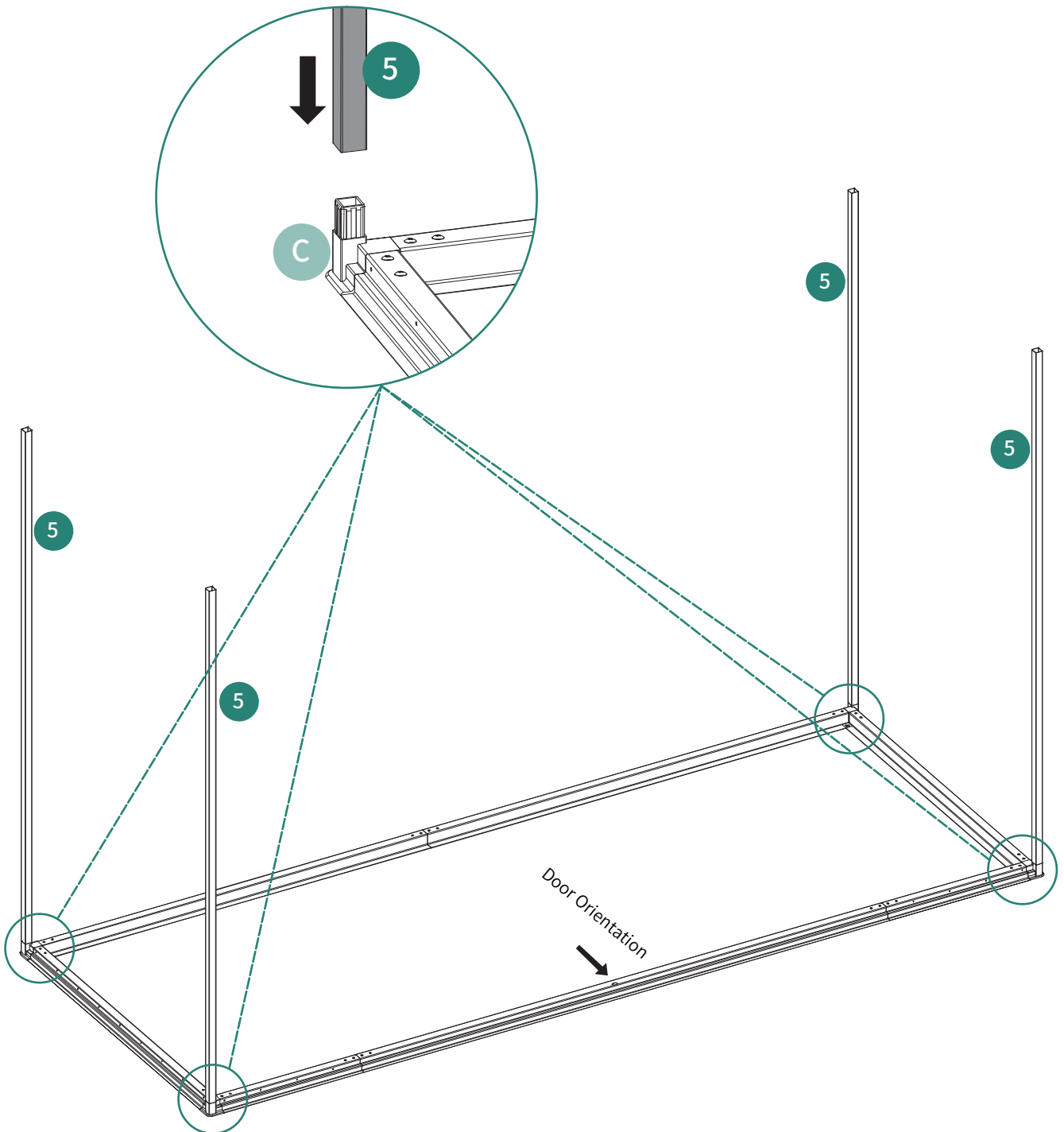

⑤ 4pcs



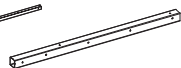

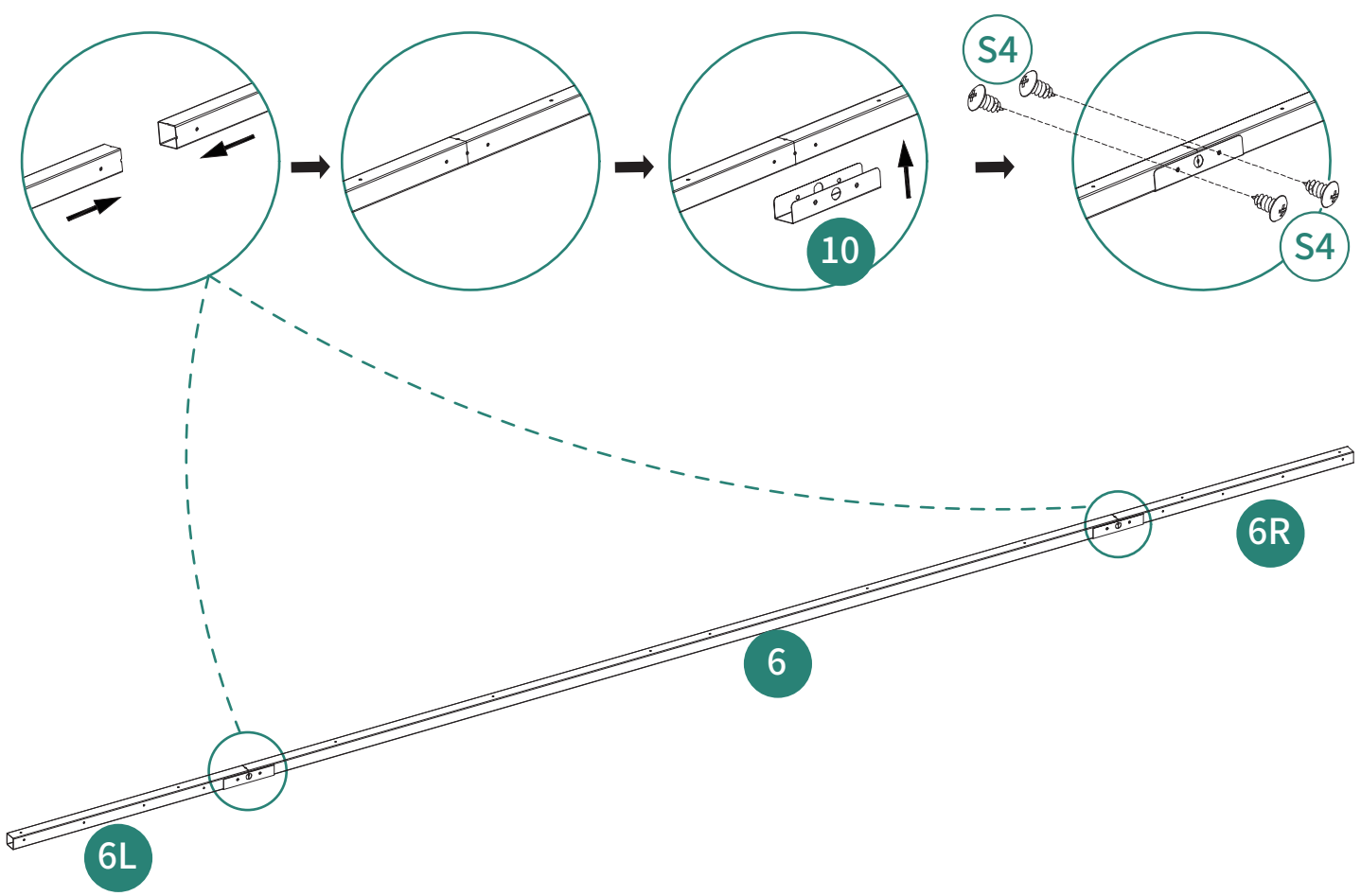

# 5

-  ⑥L 1pc
-  ⑥ 1pc
-  ⑥R 1pc
-  ⑩ 2pcs
-  S4 8pcs

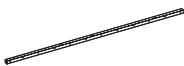

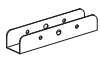
6

-  8L 1pc
-  8R 1pc
-  10 1pc
-  S4 4pcs

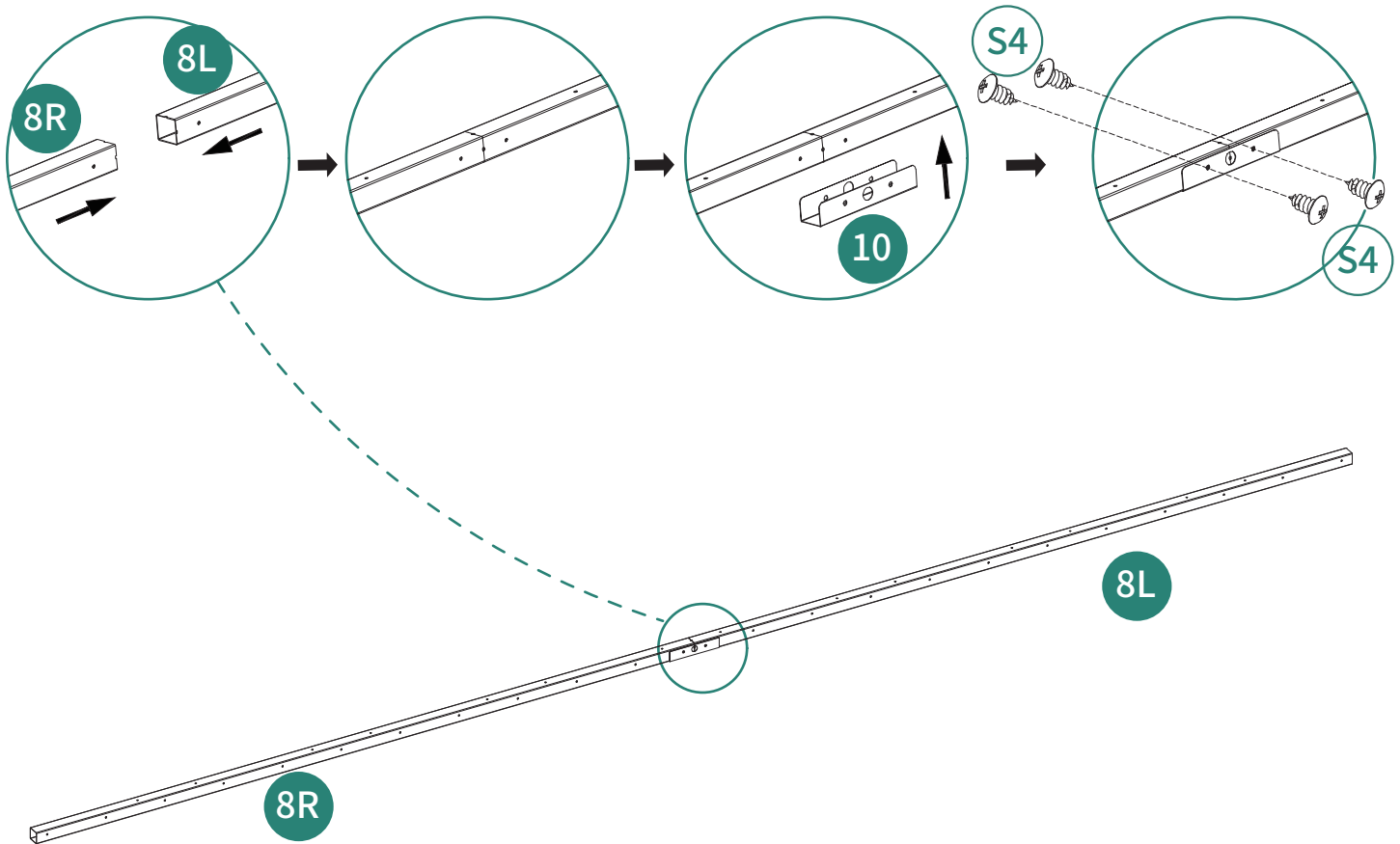

# 7



⑦ 2pcs

④ 4pcs

④ 8pcs

**NOTES:**

When assembling the beam:

1. Make sure parts (8L, 8R) have the sides with closely spaced holes facing outward, and the sides with widely spaced holes facing upward.

2. Ensure parts (6L, 6, 6R) have the sides with rectangular latch lock slot facing downward. Part 6L should be on the left side and part 6R on the right side.

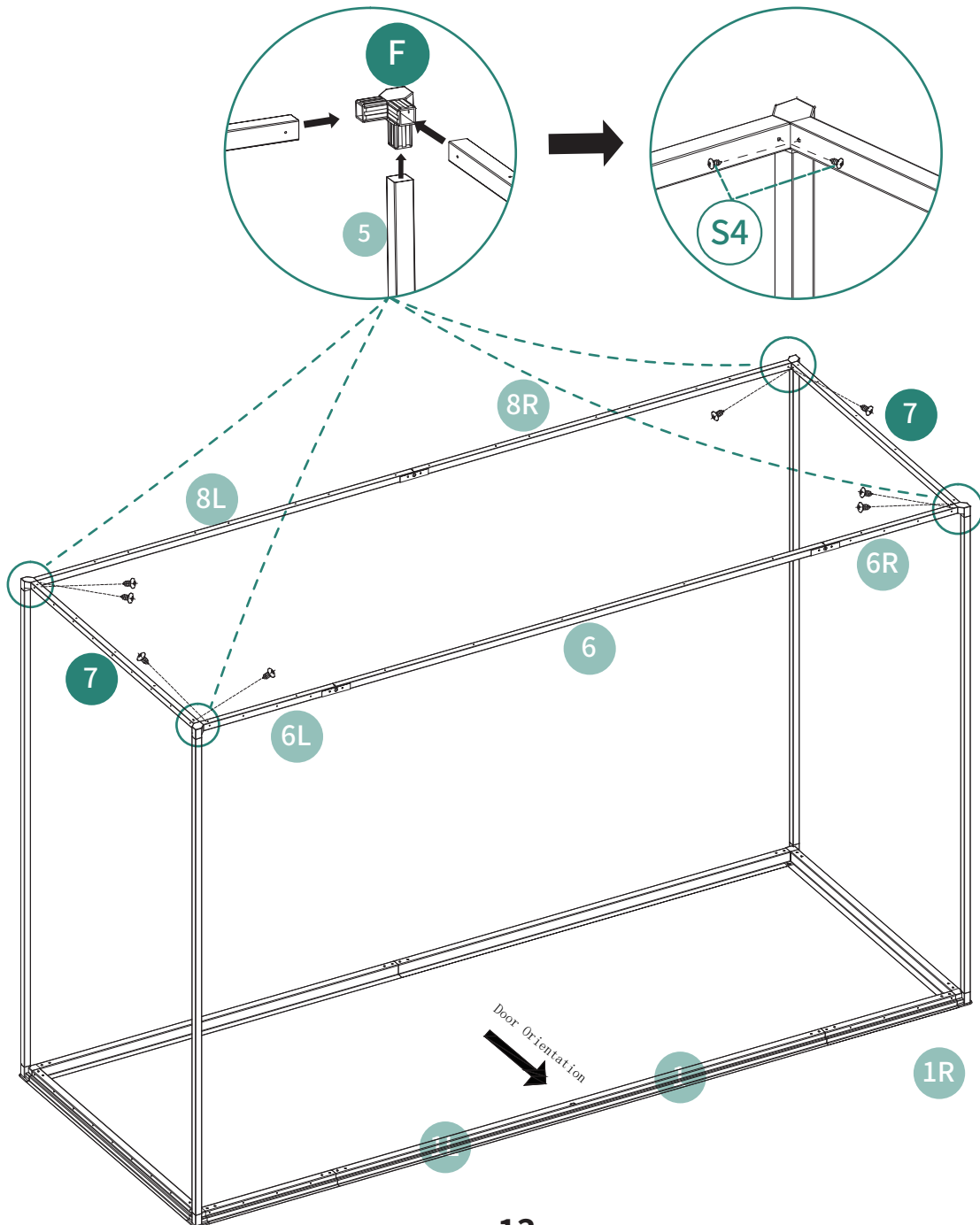

# 8



W5 2pcs

W7 2pcs

S4 18pcs

S6 3pcs

S7 3pcs

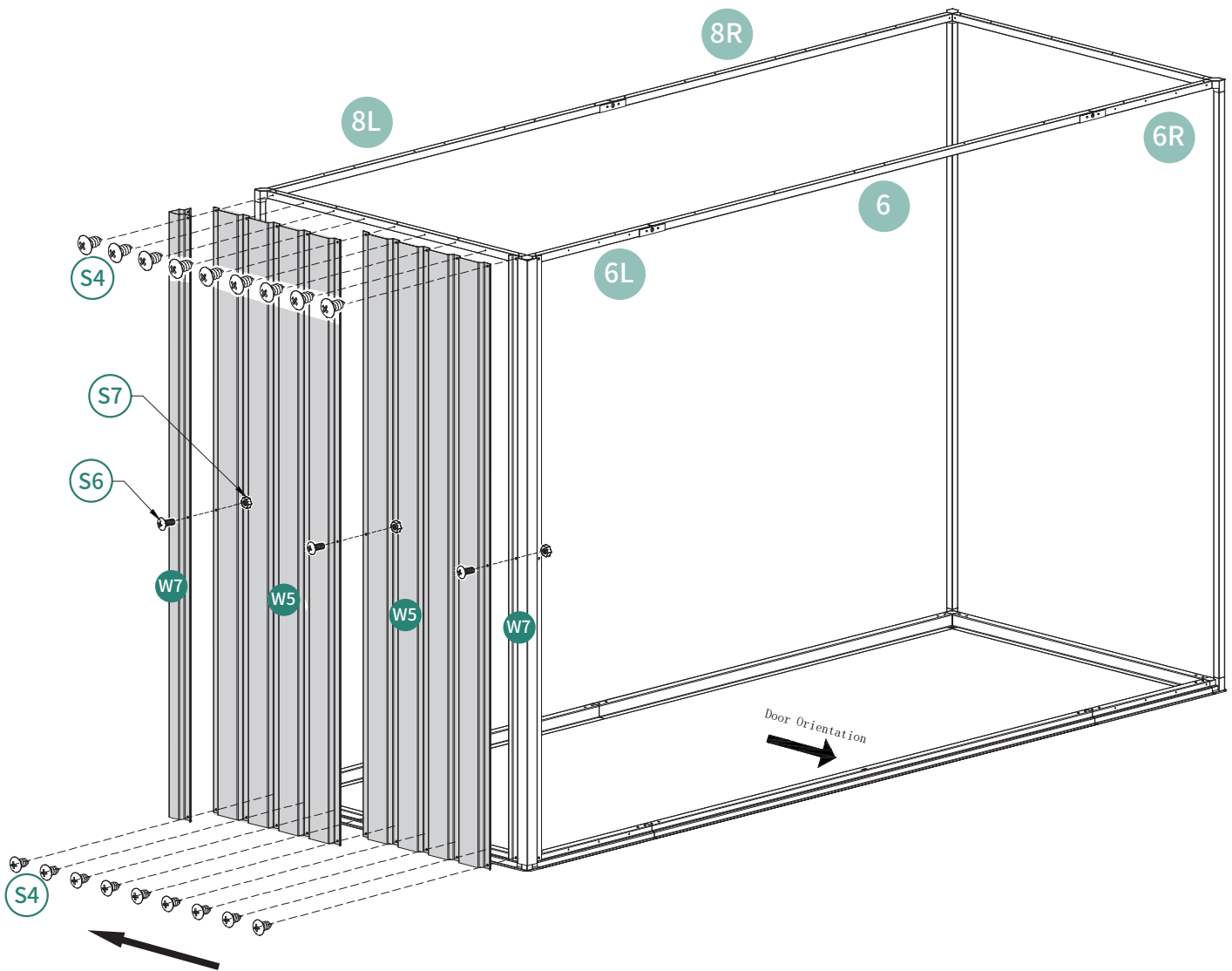

Secure the screws sequentially as indicated by the arrow.

# 9



W3 2pcs

W5 4pcs

W7 1pc

S4 46pcs

S6 7pcs

S7 7pcs

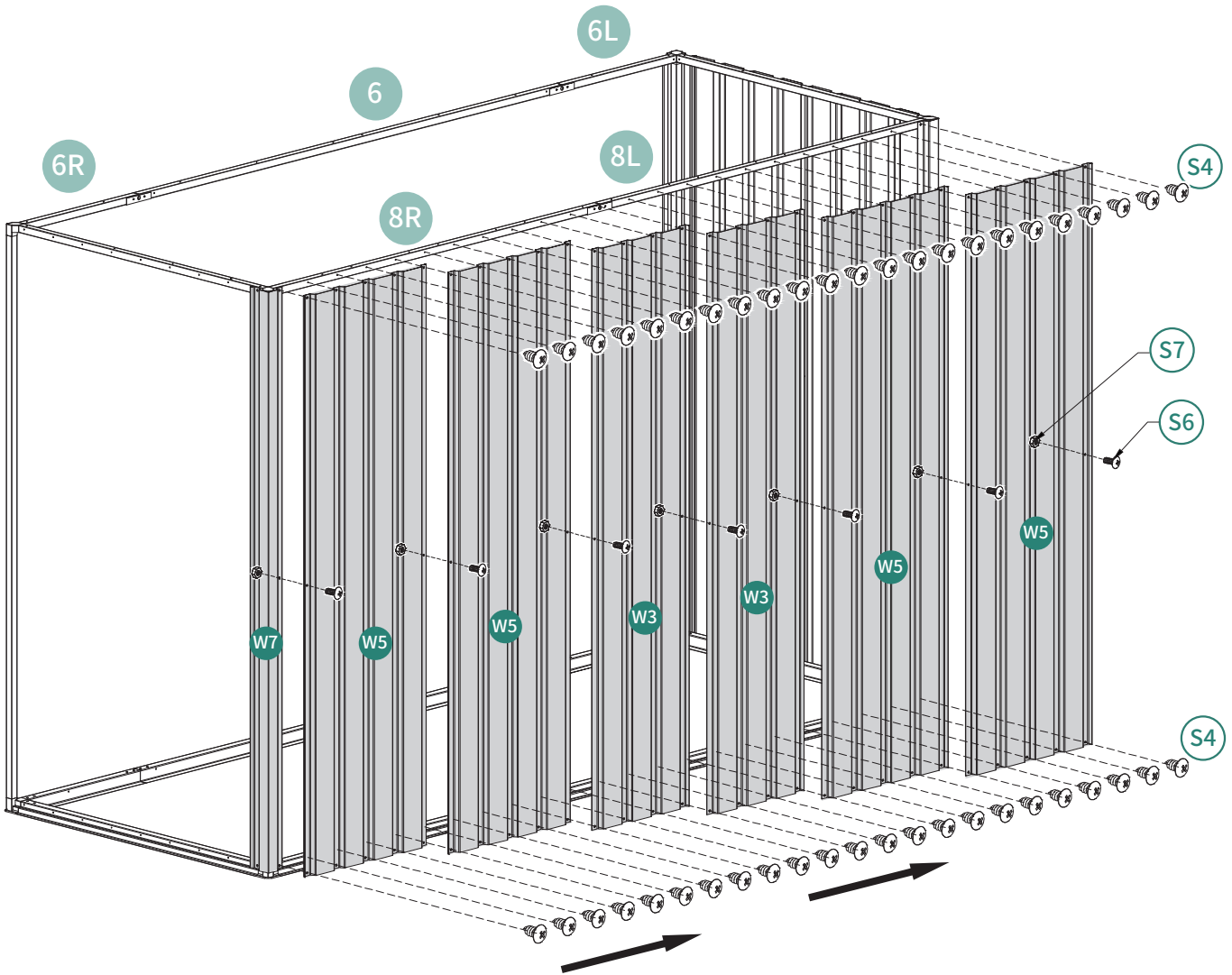

Secure the screws sequentially as indicated by the arrow.

# 10



W5 2pcs



W7 1pc



S4 18pcs



S6 3pcs



S7 3pcs

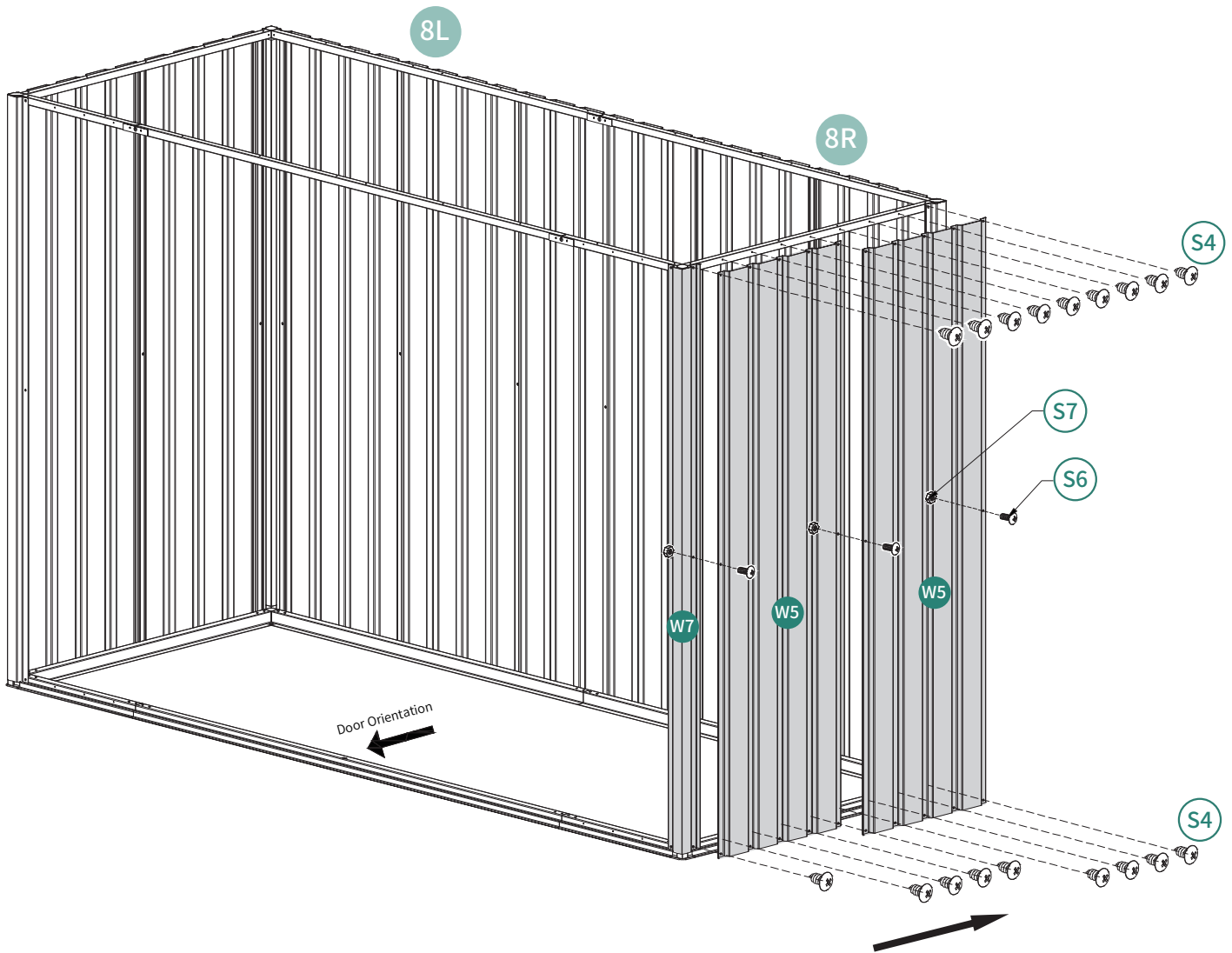

Secure the screws sequentially as indicated by the arrow.

# 11



W3 2pcs 17L 1pc 17R 1pc S4 20pcs S6 4pcs S7 4pcs

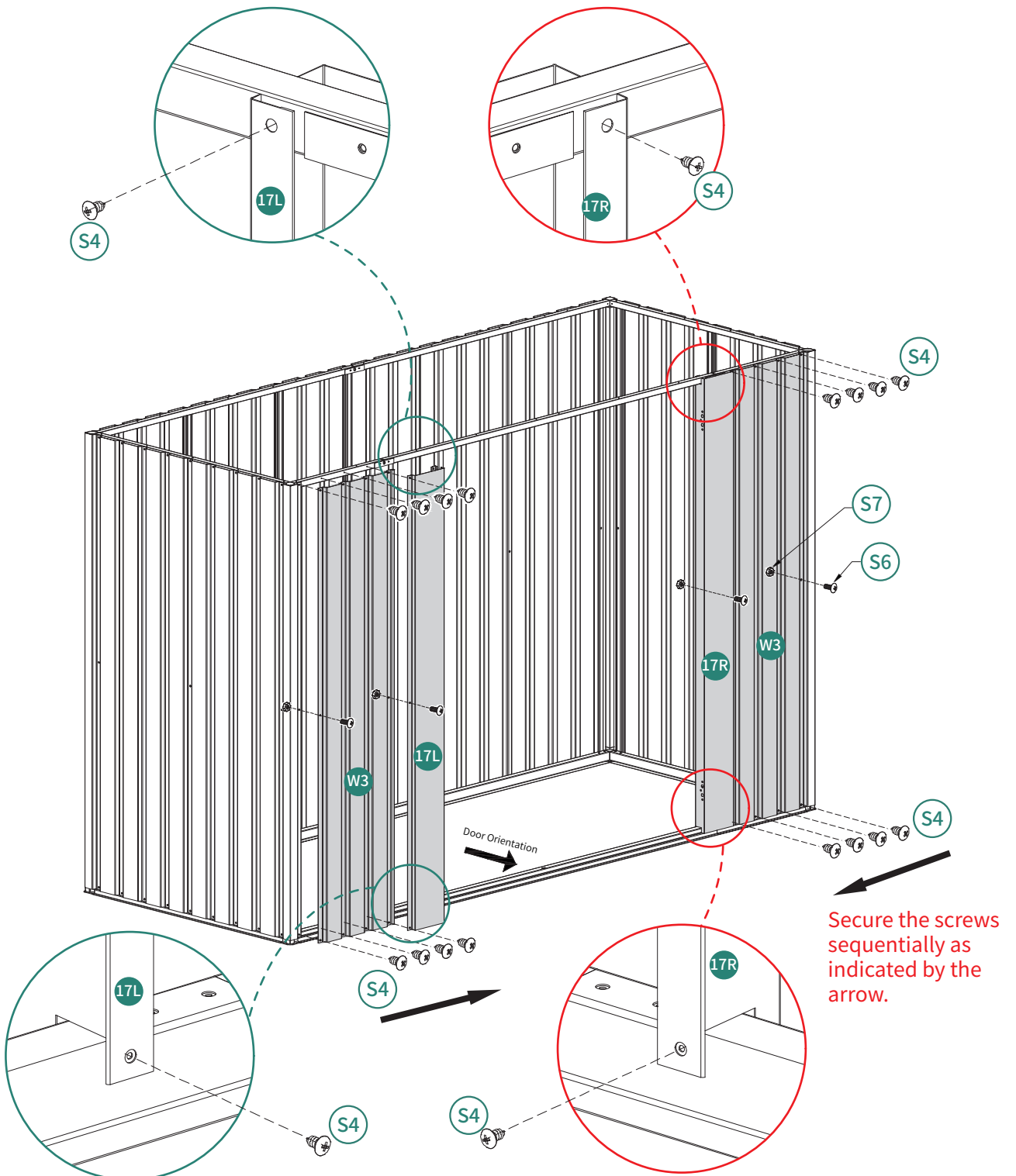

12

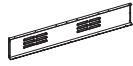

24L 1pc

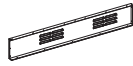

24R 1pc



S6 2pcs



S7 2pcs

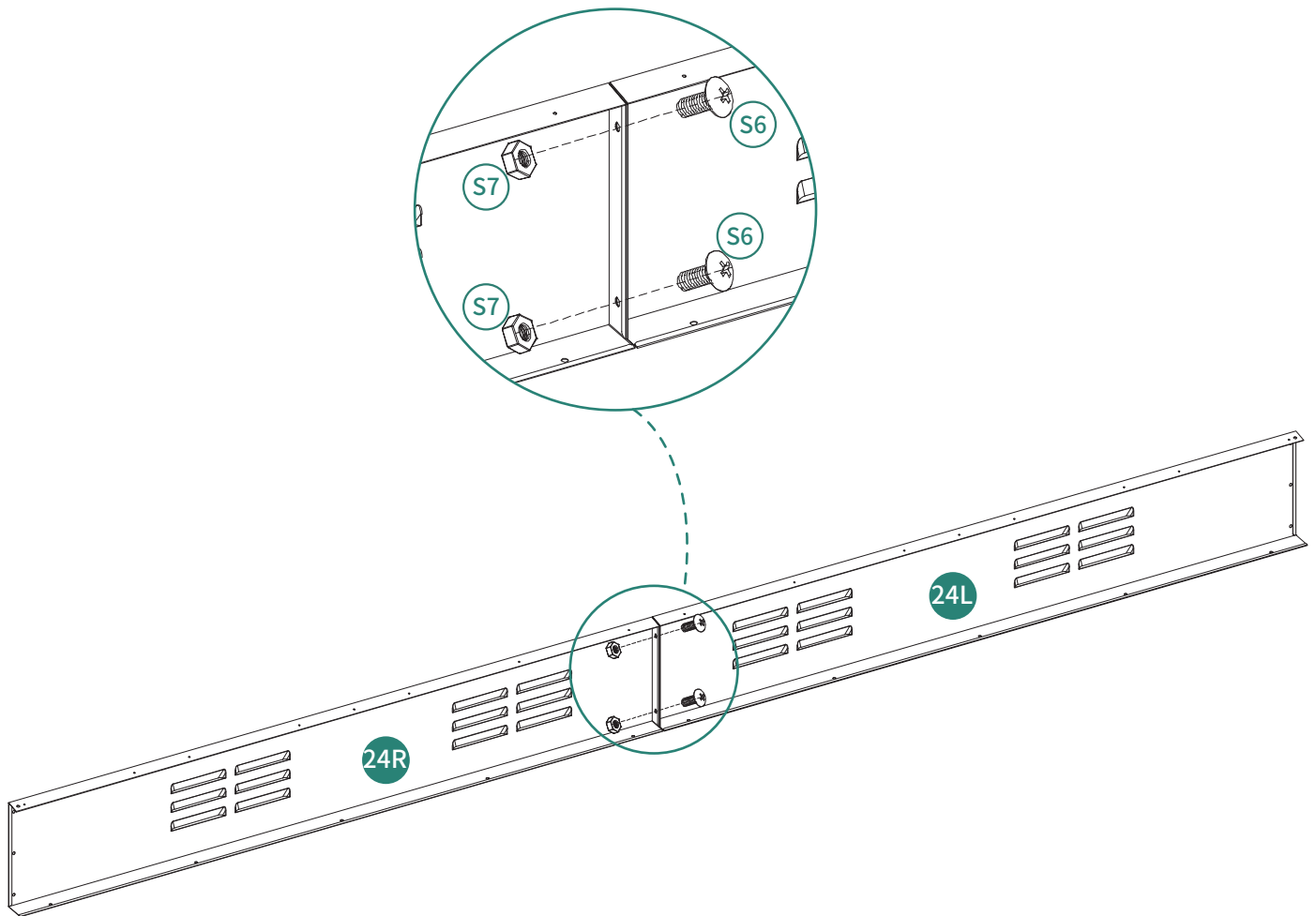





**13**

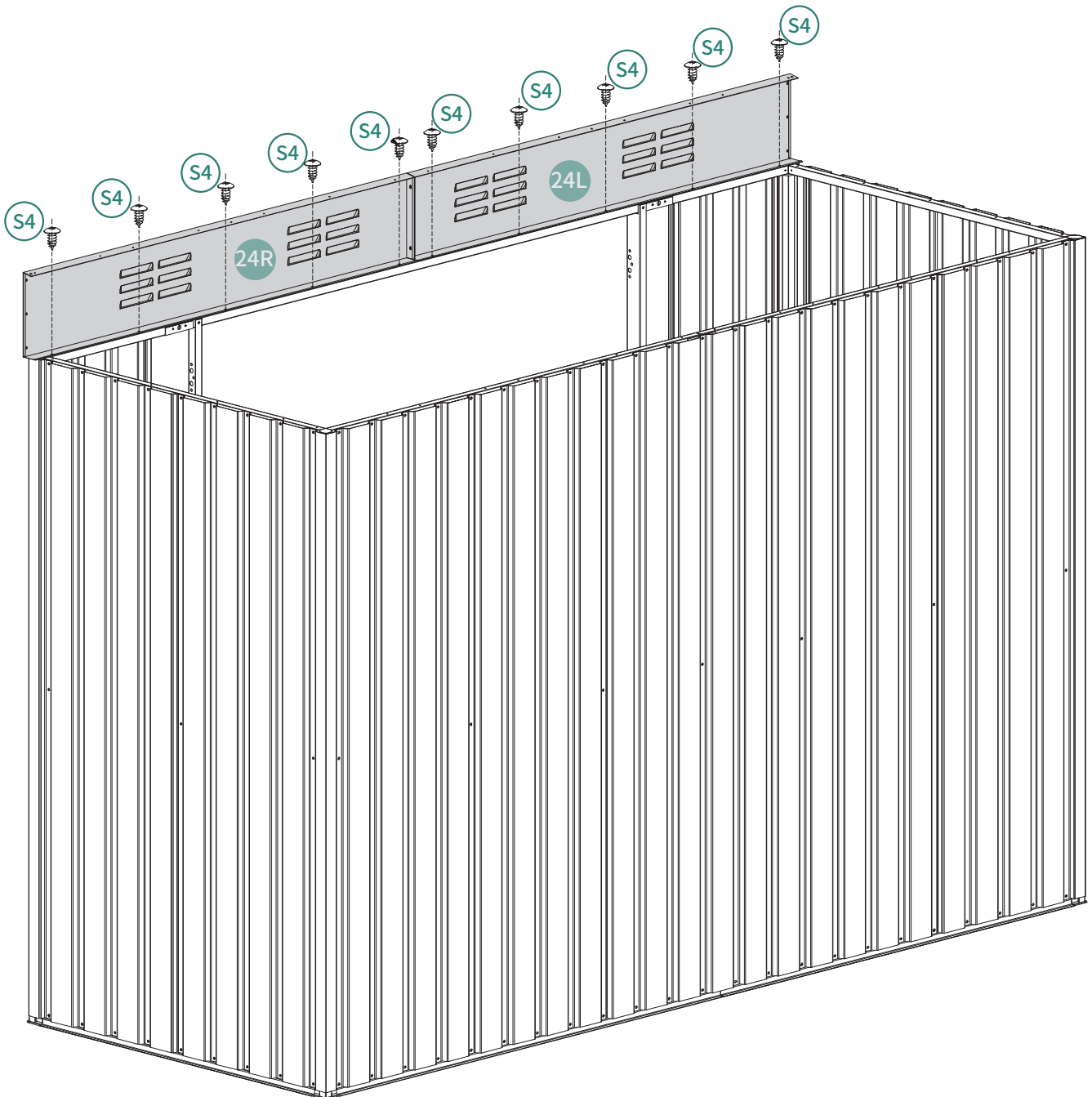

S4 10pcs



# 14

-  21L 1pc
-  21R 1pc
-  S4 12pcs
-  S6 6pcs
-  S7 6pcs

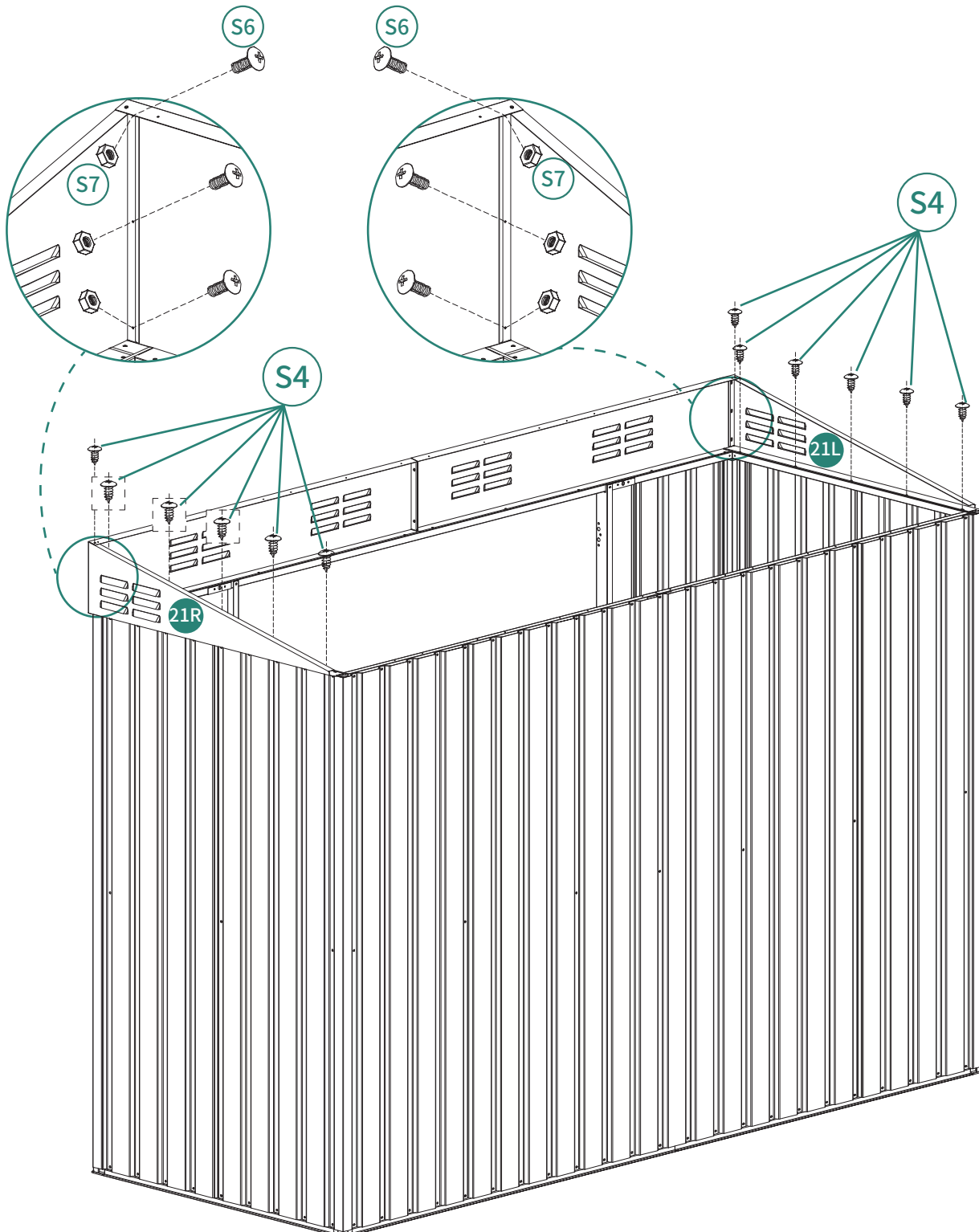

# 15

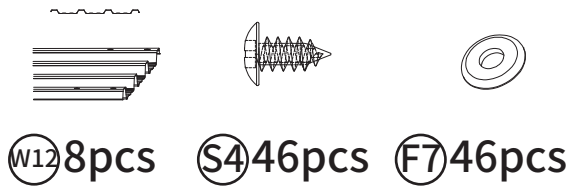

Pay attention to the placement of the fastening screws at the overlap joints when installing corrugated roofing.

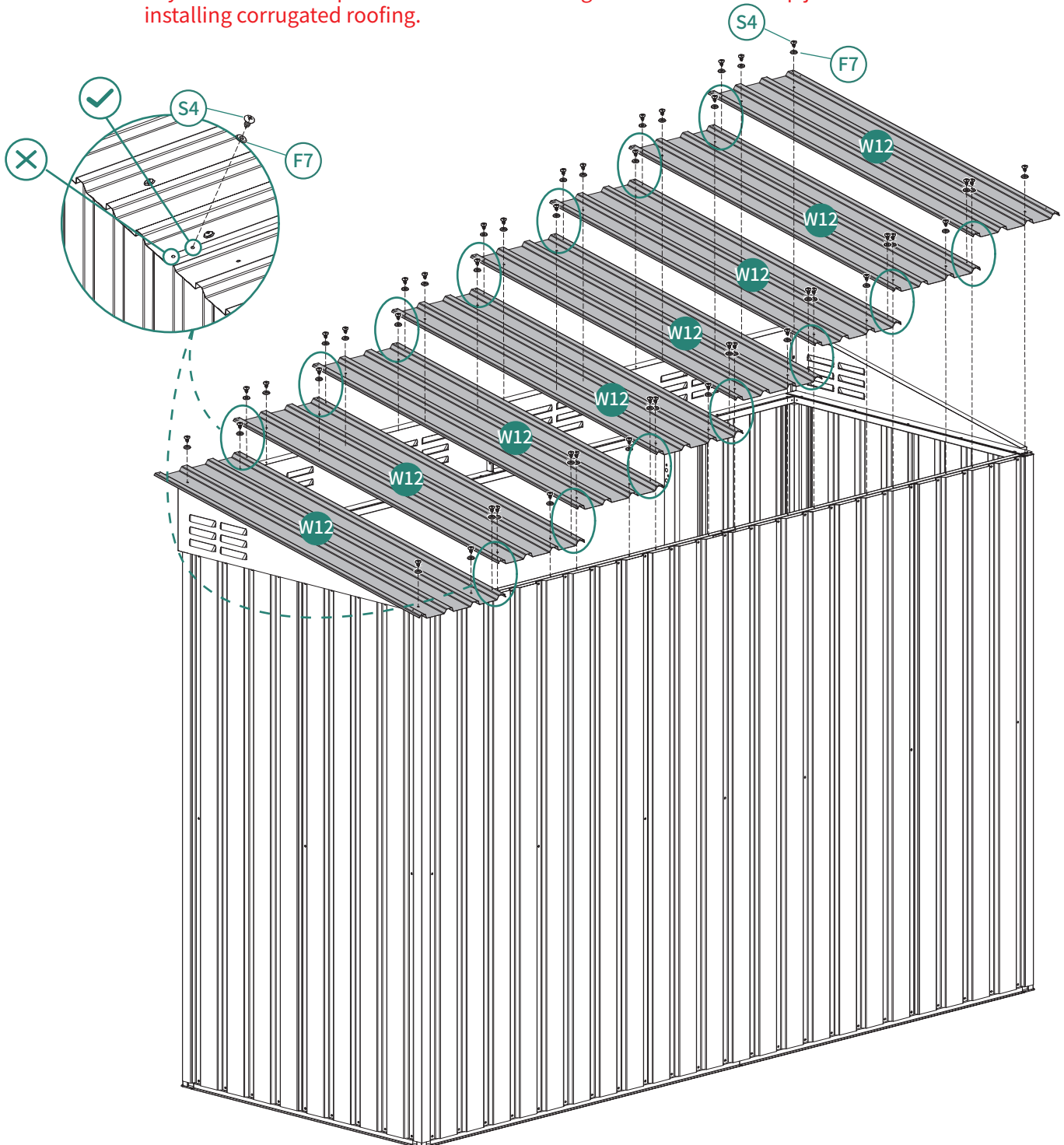

# 16

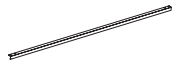

20 2pcs



S4 4pcs



F7 4pcs

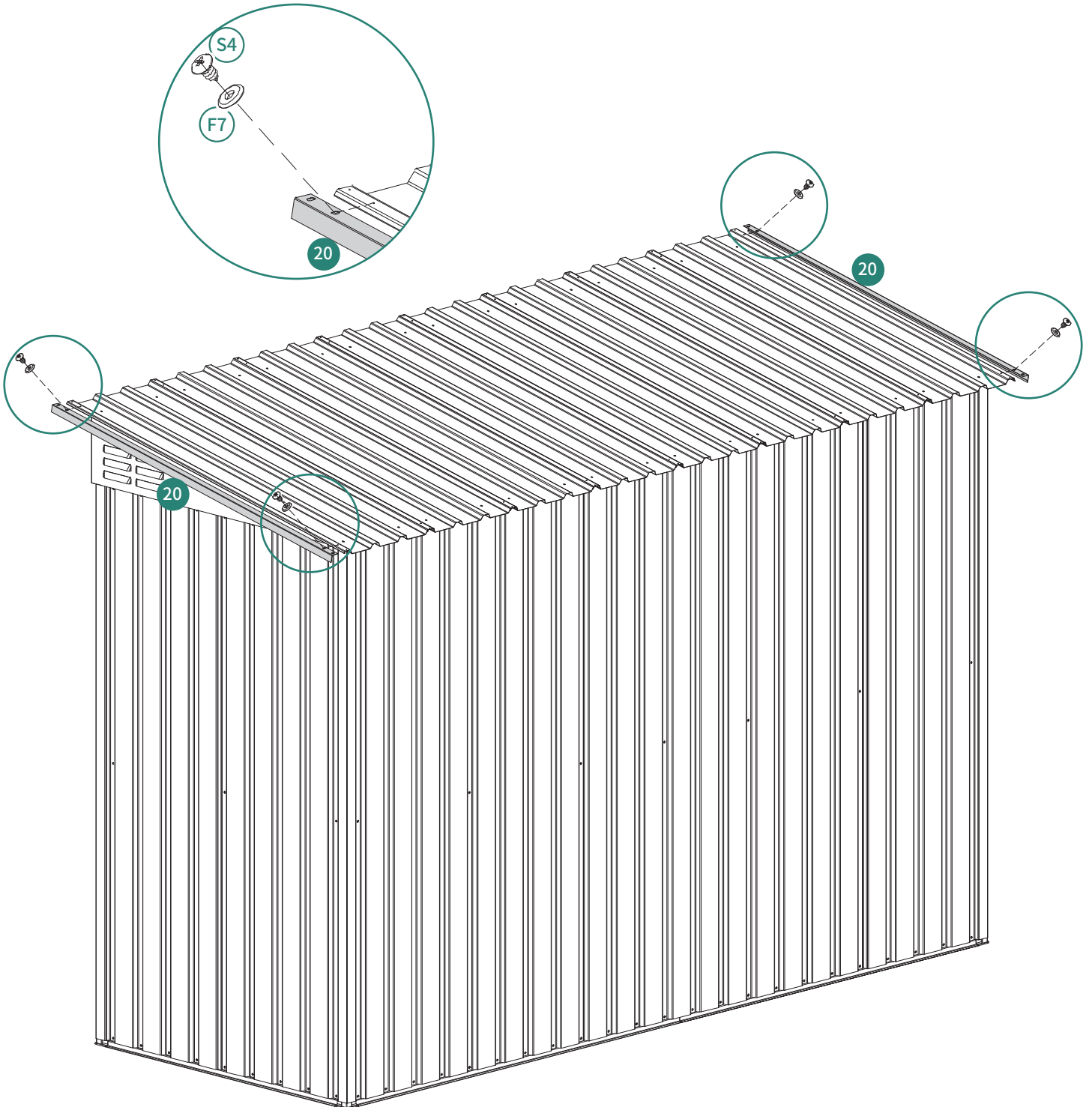

# 17

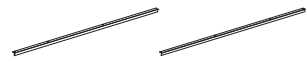

ⓑ19L 2pcs ⓑ19R 2pcs ⓐS4 12pcs ⓐS8 6pcs ⓐF7 18pcs ⓐF4 4pcs ⓐF10 2pcs

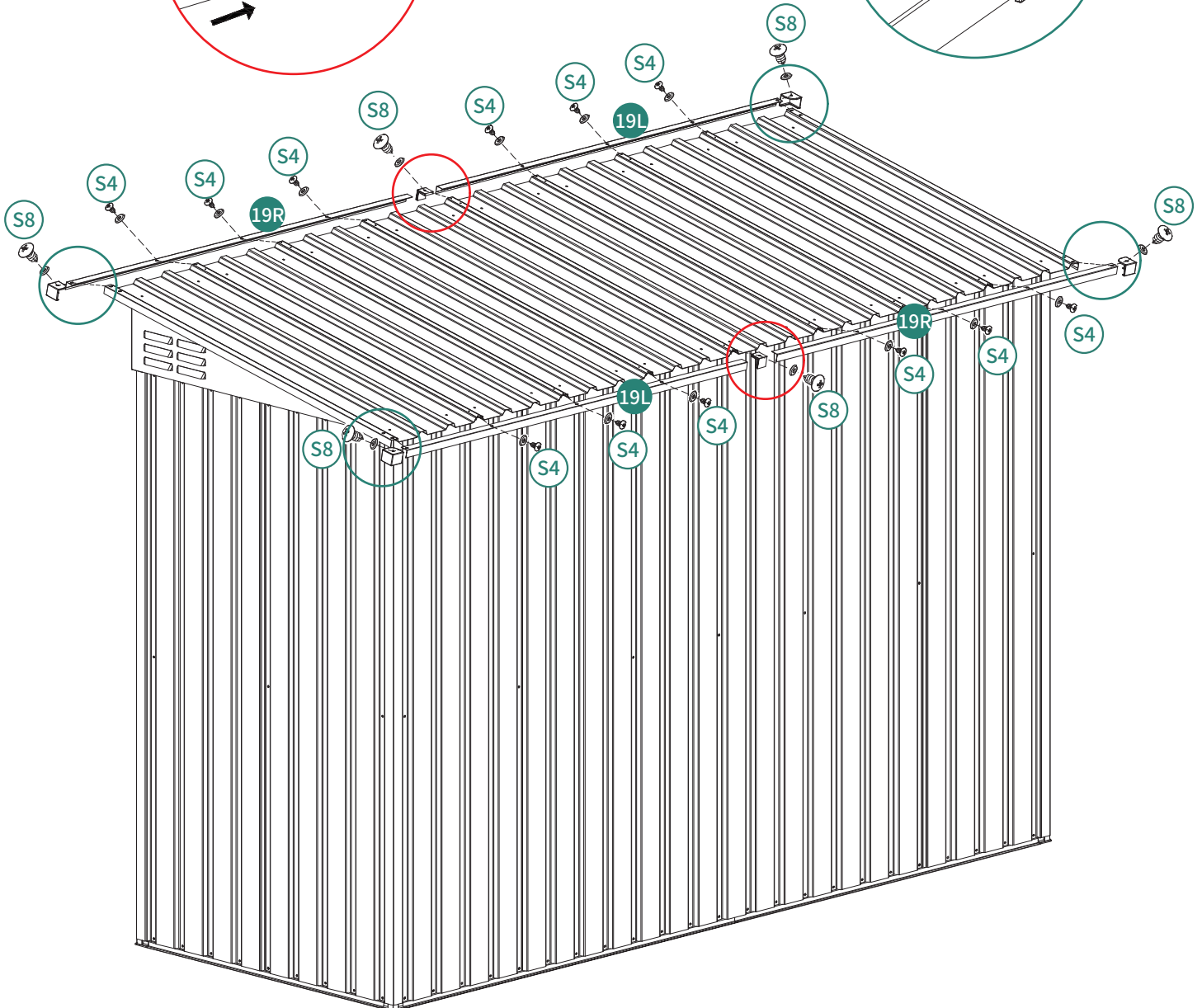
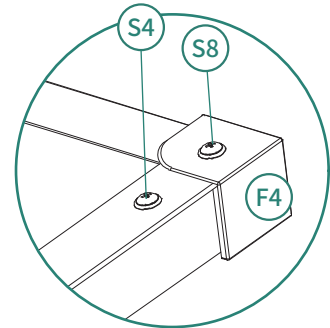
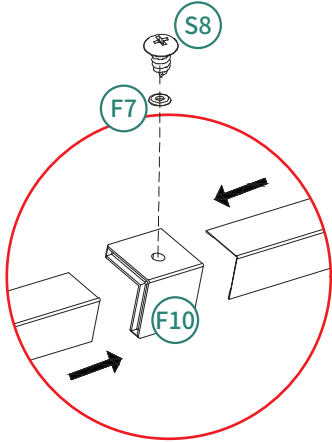

**18**



**F8** 52pcs

After fixing the screws, there will be some exposed screw parts on the component.  
Please use the provided plastic protective covers to protect the exposed screw parts,  
to avoid scratches during use.

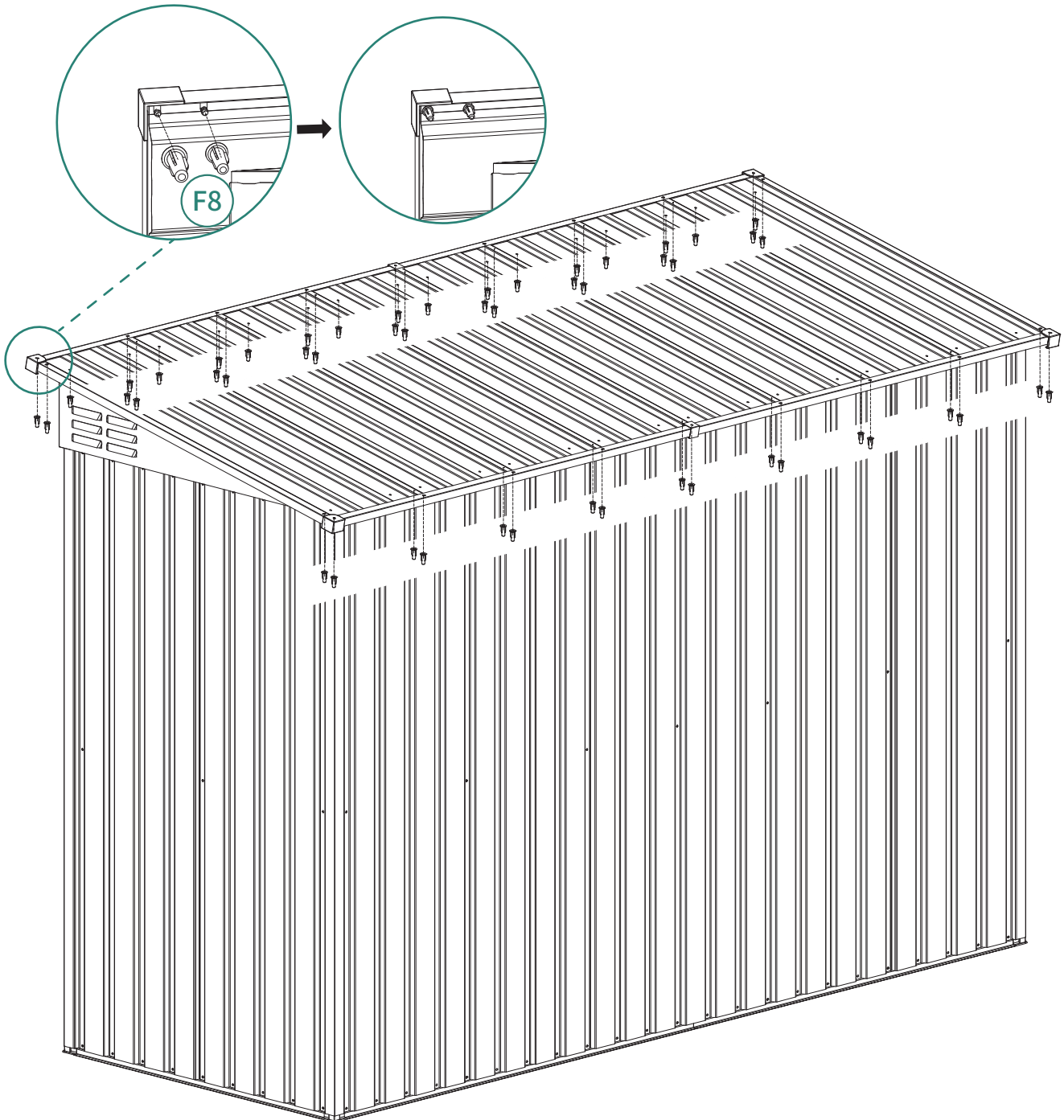

# 19

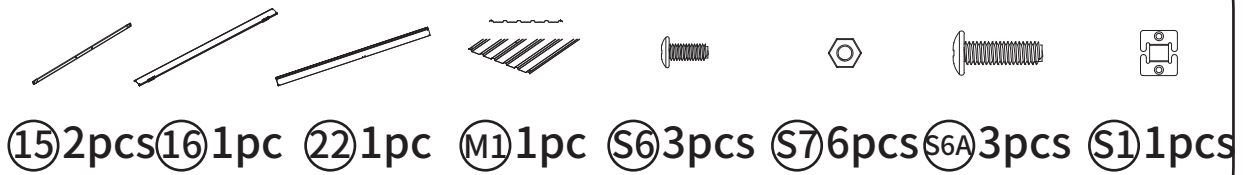

Install part 16 to the side of part M1 (front side panel) with the longer distance from the center screw hole to the edge, and part 22 to the side with the shorter distance.

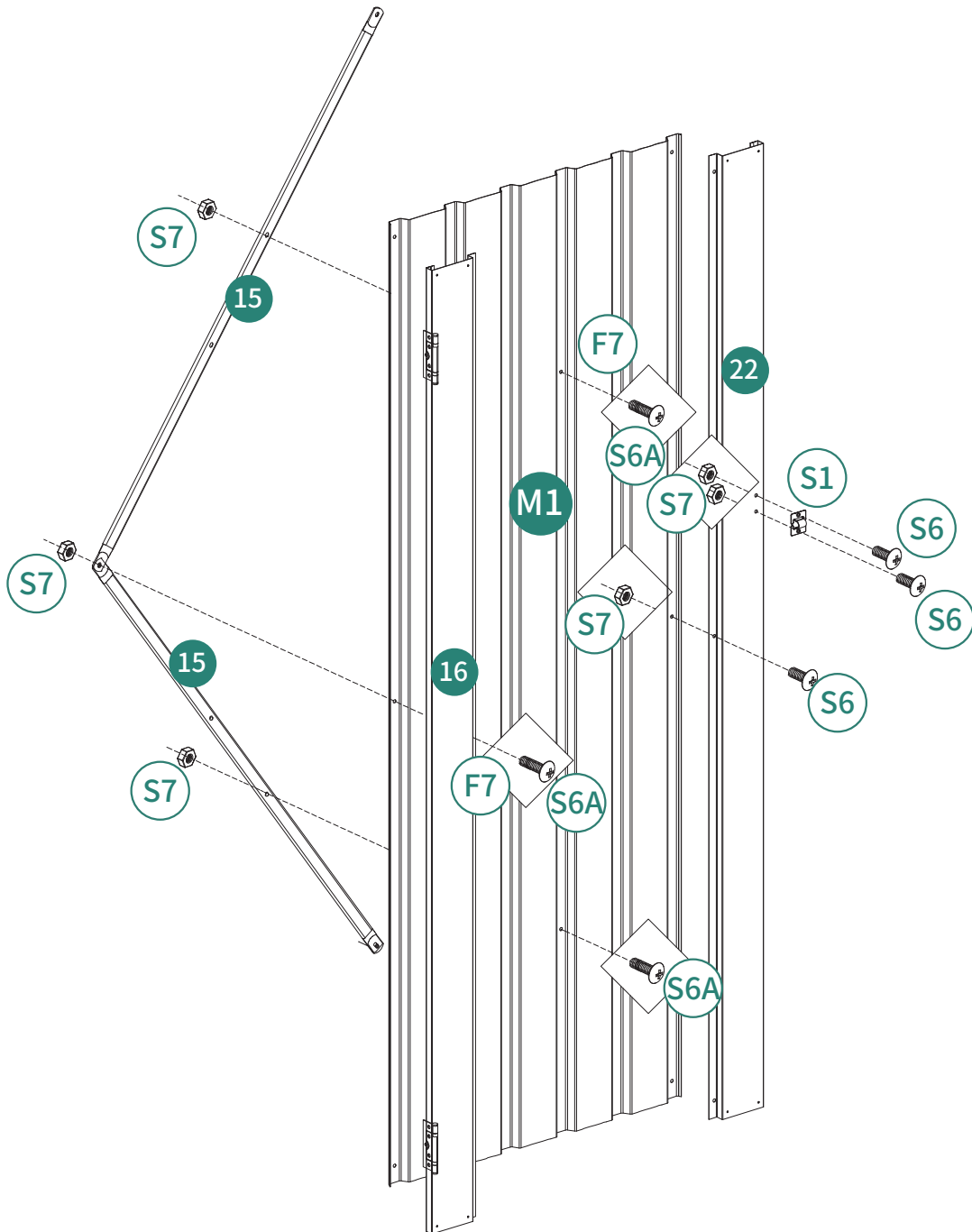

20



21 2pcs



S4 8pcs

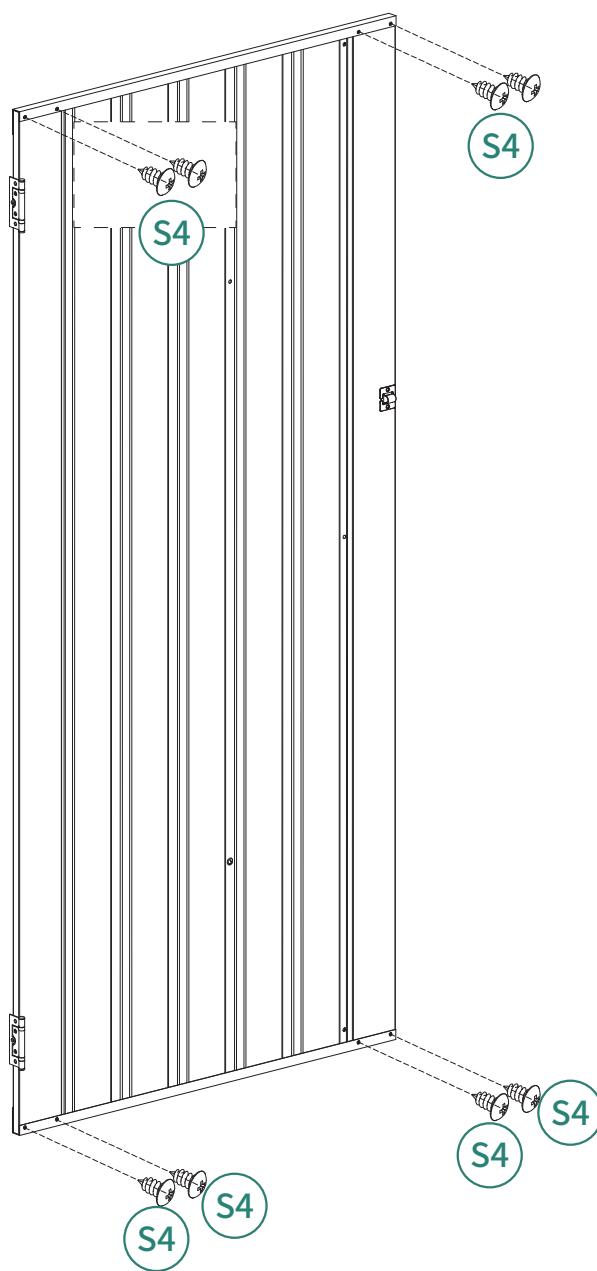
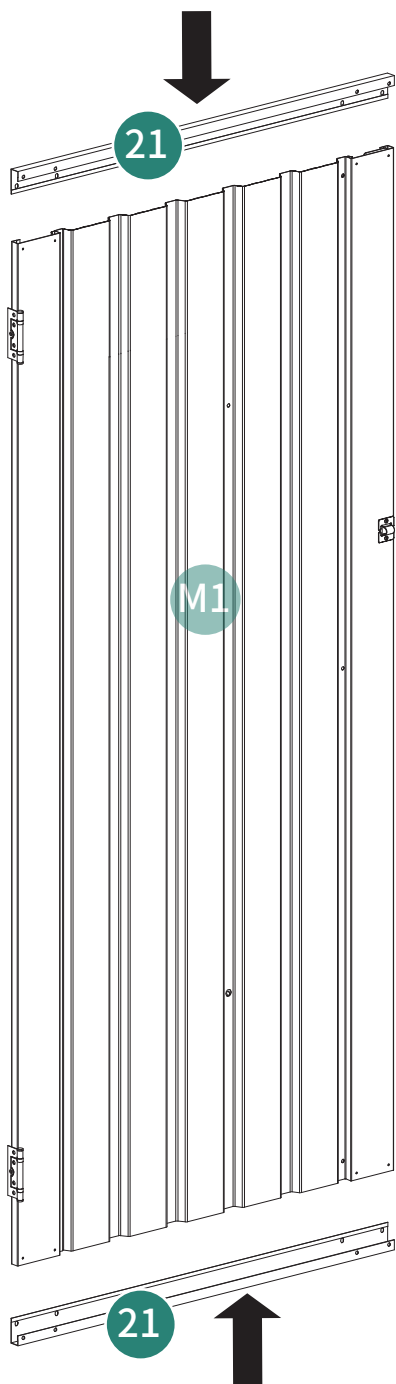

# 21

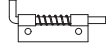
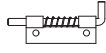

(S4) 2pcs

(S5L) 1pc

(S5R) 1pc

(S6) 6pcs

(S6A) 2pcs

(S7) 8pcs

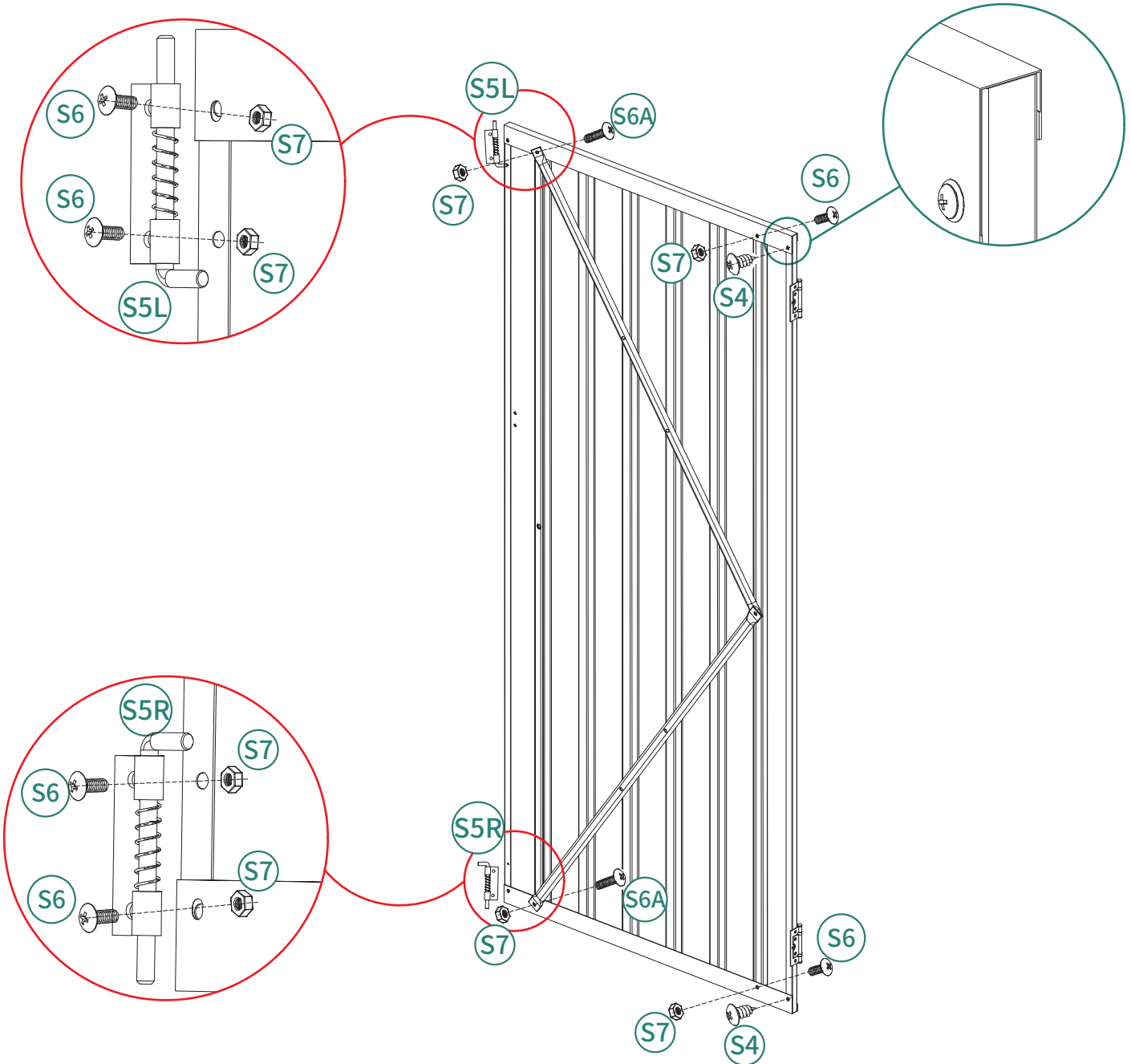

# 22

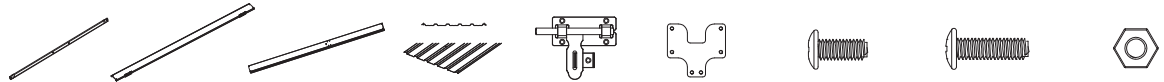
- 
- ⑮ 2pcs ⑯ 1pc ⑰ 1pc M1 1pc ⑳ 1pc ㉑ 1pc ㉒ 7pcs ㉓ 3pcs ㉔ 4pcs

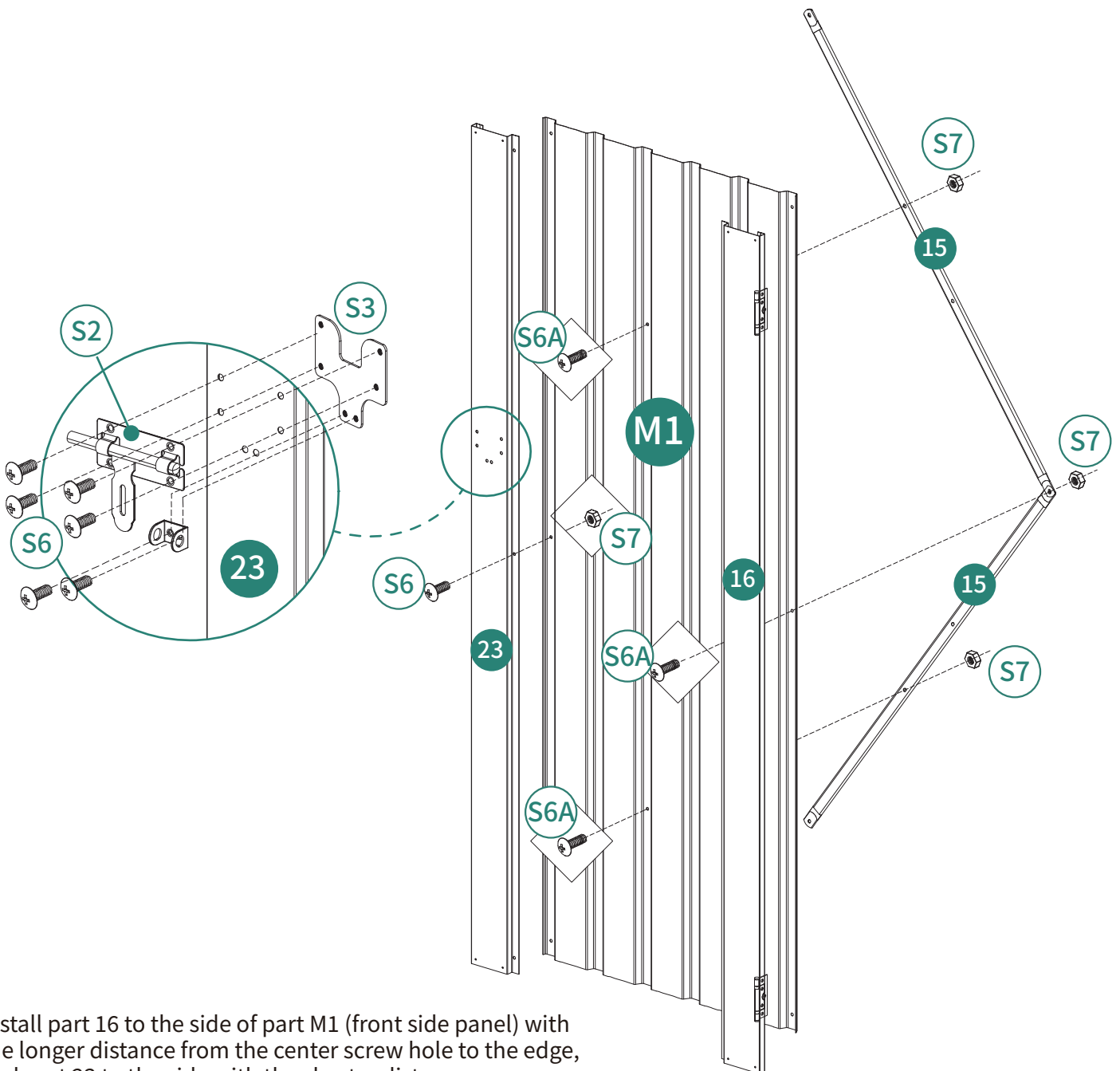

Install part 16 to the side of part M1 (front side panel) with the longer distance from the center screw hole to the edge, and part 23 to the side with the shorter distance.

23



21) 2 pcs



S4) 8 pcs

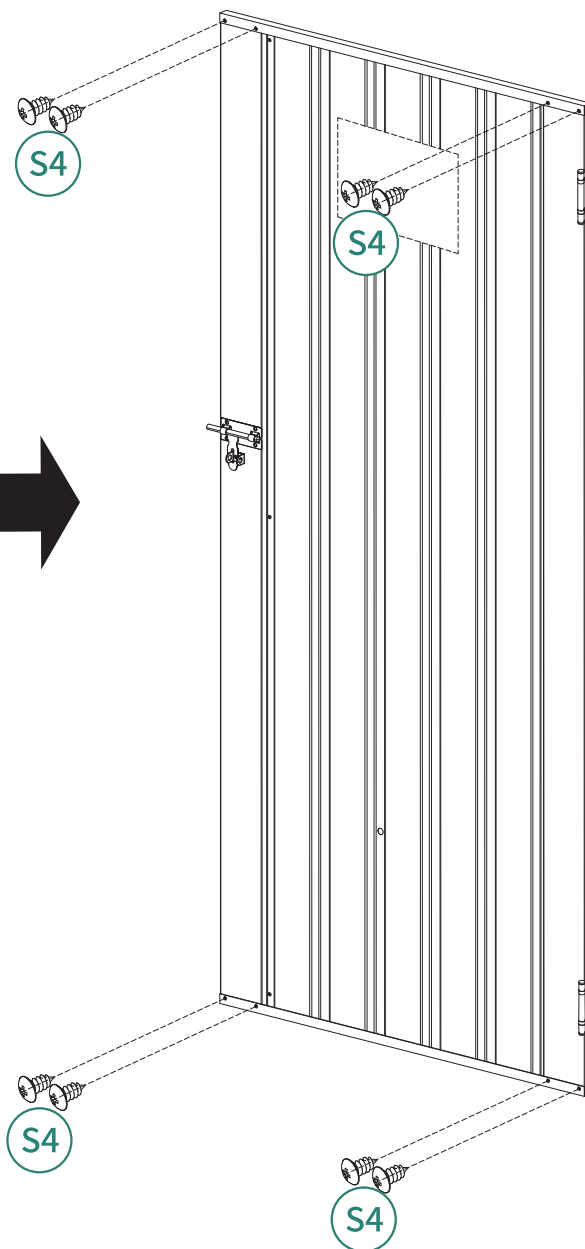
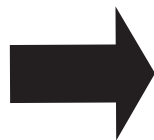
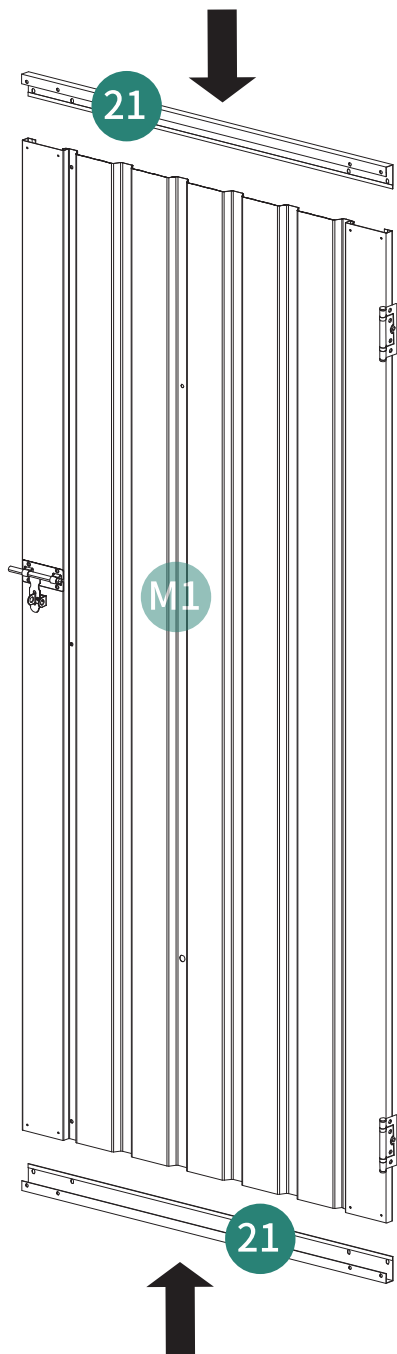

24



S4 4pcs

S6 2pcs

S6A 2pcs

S7 4pcs

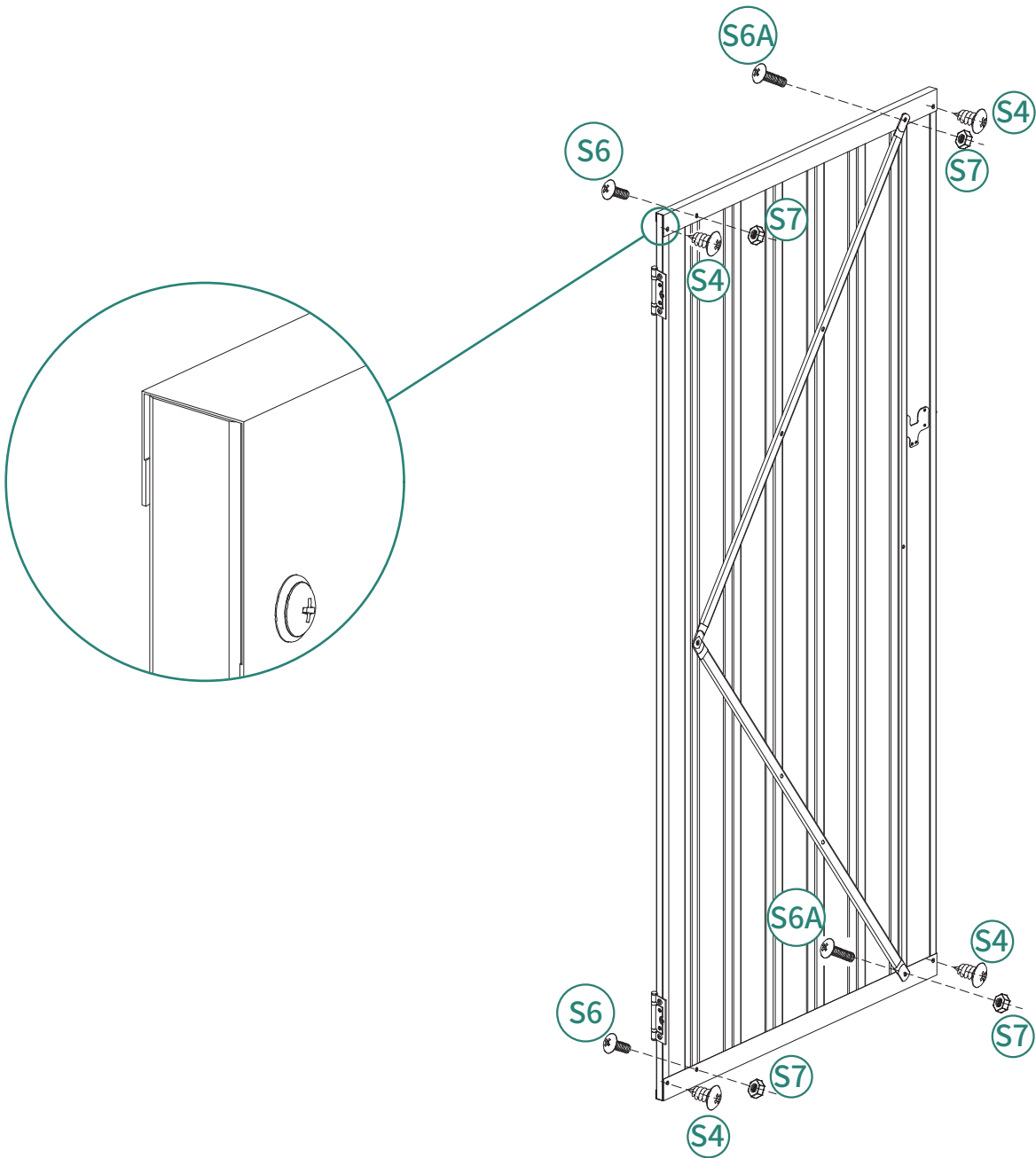

25

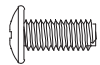

S6 12pcs

S7 12pcs

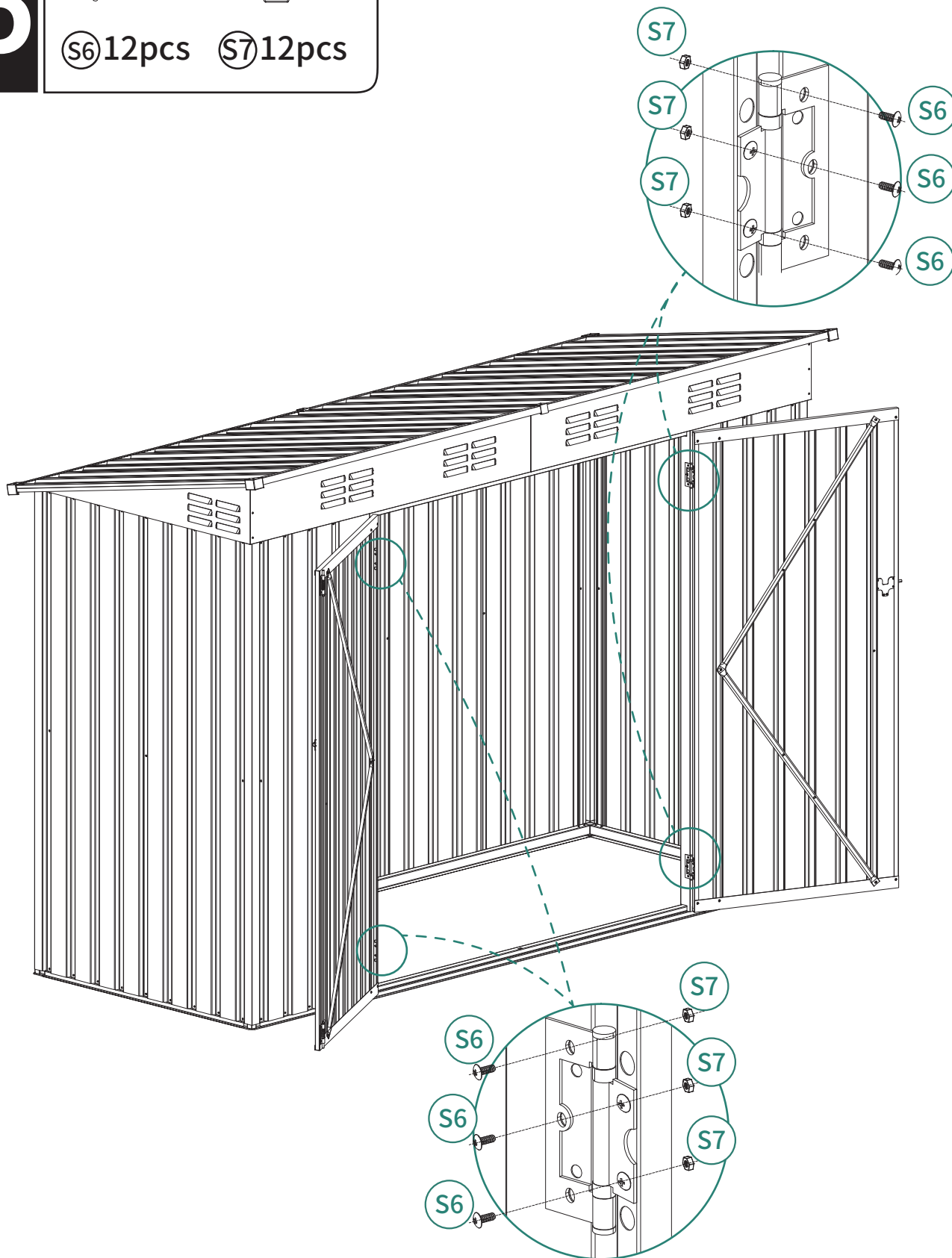

# 26



(S9) 4pcs

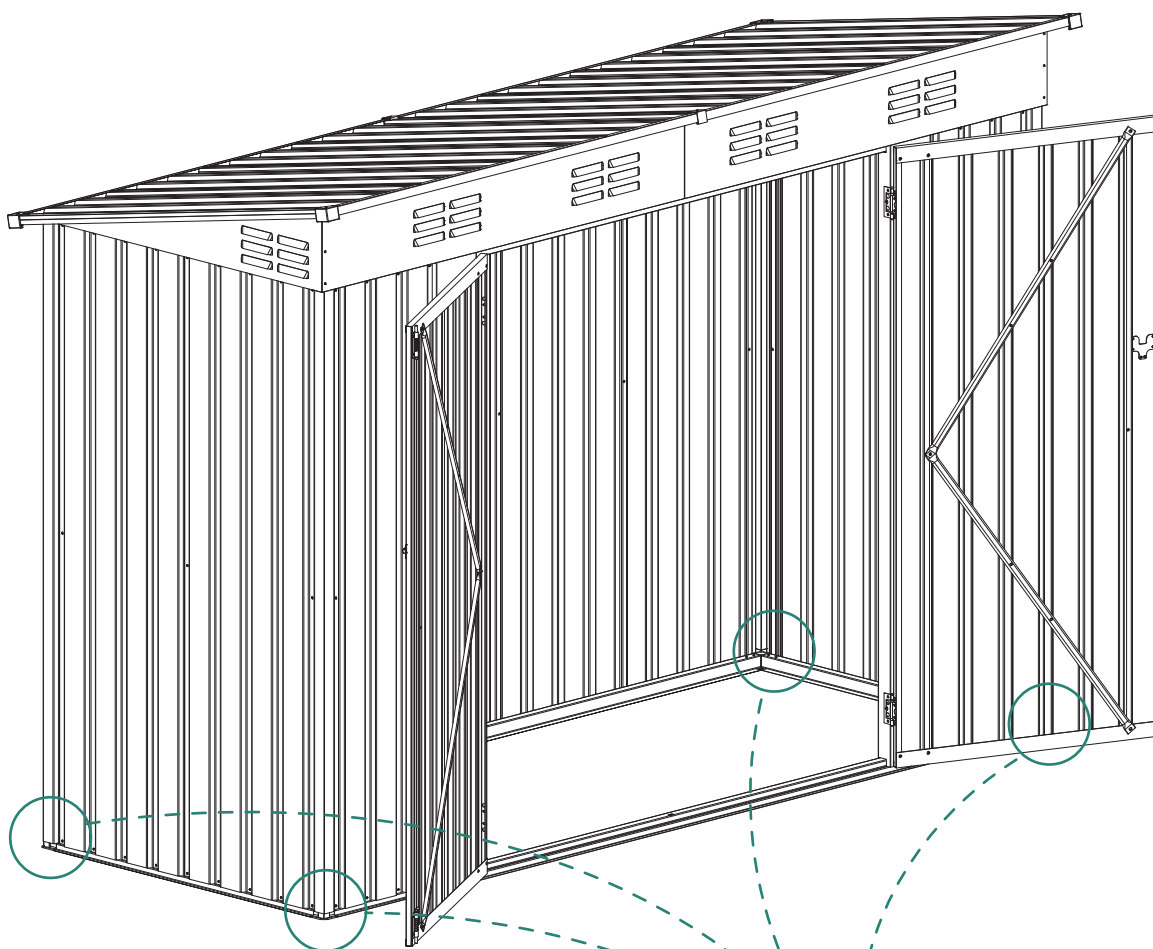

To improve the wind resistance, please be sure to complete this installation step. If expansion bolts or ground stakes are not installed, strong winds may cause the tool shed to collapse. Expansion bolts are crucial for the stability on concrete surfaces, and ground stakes are used for grassy areas. The accessory package includes the ground stake components, but the expansion bolts are not included.

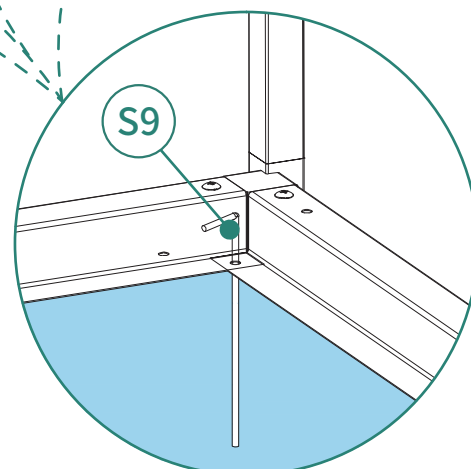

27

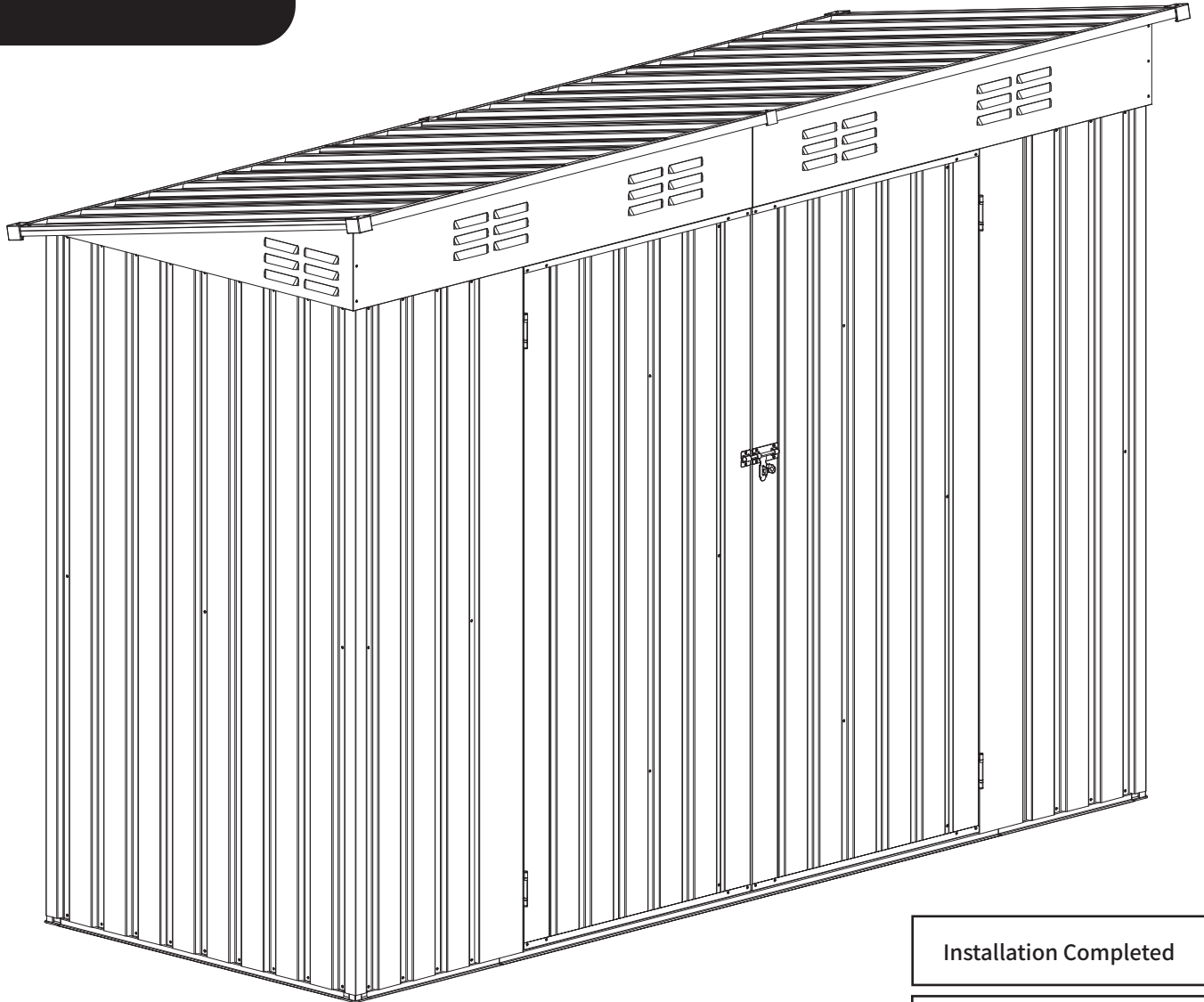

Installation Completed

Installation Abgeschlossen

Installation Complétée

Installazione Completata

Instalación Completada

# HELP CENTER



Inquiry



Assembly issue



Missing parts

If you encounter any difficulties during assembly, please contact us.

Wenn Sie während der Montage auf Schwierigkeiten stoßen, kontaktieren Sie uns bitte.

Si vous rencontrez des difficultés lors du montage, veuillez nous contacter.

Se incontri difficoltà durante il montaggio, ti preghiamo di contattarci.

Si encuentras alguna dificultad durante el ensamblaje, por favor contáctanos.

# DISCLAIMER

Manufacturer and seller expressly disclaim any and all liability for personal injury, property damage or loss, whether direct, indirect, or incidental, resulting from the incorrect attachment, improper use, inadequate maintenance, unapproved modification, or neglect of this product.

Der Hersteller und Verkäufer lehnen ausdrücklich jegliche Haftung für Personenschäden, Sachschäden oder Verluste ab, egal ob direkt, indirekt oder zufällig, die durch falsche Anbringung, unsachgemäßen Gebrauch, unzureichende Wartung, nicht genehmigte Änderungen oder Vernachlässigung dieses Produkts entstehen.

El fabricante y vendedor renuncian expresamente a toda responsabilidad por lesiones personales, daños materiales o pérdidas, ya sean directos, indirectos o incidentales, derivados de la incorrecta colocación, uso inadecuado, mantenimiento insuficiente, modificación no aprobada o negligencia de este producto.

Il produttore e il venditore declinano espressamente ogni responsabilità per lesioni personali, danni materiali o perdite, dirette, indirette o incidentali, derivanti dall'errato fissaggio, uso improprio, manutenzione inadeguata, modifica non autorizzata o negligenza di questo prodotto. Le fabricant et le vendeur déclinent expressément toute responsabilité en cas de blessures corporelles, de dommages matériels ou de pertes, qu'ils soient directs, indirects ou accessoires, résultant de la fixation incorrecte, de l'utilisation inappropriée, de l'entretien insuffisant, de la modification non approuvée ou de la négligence de ce produit.