

Instruction Manual

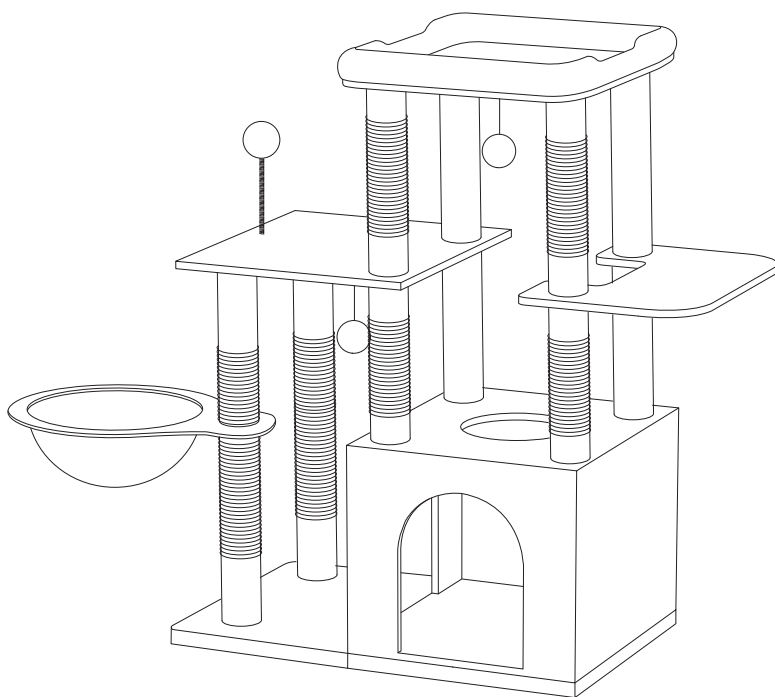

Thanks for your great support on us. Any questions or difficulty with assembly, please feel free to contact us first. Our customer service will surely address your concerns in 24 hours.

Guide of Manual

- Please read the instruction carefully and use the product appropriately.
- Please keep this manual and hand it over when you transfer the product.
- This summary may not include every detail of all variations and considered steps. Please contact us when further information and help are needed.

Warning

- Do not stand or climb to avoid the risk of injuries. Keep away from children. Be aware of danger!
- If your cat starts to chew or eat the product material, please keep your cat away from it and contact pet doctor.
- Persons with allergies should avoid assembling the product.
- Keep children away during assembly as small parts may be fatal if swallowed or inhaled. Keep all packaging materials (film, plastic bag, foam, etc.) out of the reach of children and babies to avoid choking, suffocation and other potential risks.

Notes

- The product is only designed for cats to play, climb, rest and sharpen their claws. The seller does not assume any responsibility or liability with respect to any damage caused by incorrect assembly or improper use.
- Our products are carefully designed for indoor use only. Any commercial use or outdoor use must be approved prior to purchase.
- If the package smells when opened, place the product in a well-ventilated area for 3-5 days to eliminate odors.
- When assembling, please follow the correct steps and take necessary security measures, such as wearing a pair of gloves, so as not to hurt your hands. Check the firmness of all parts monthly.
- Do not put any other items on the product.
- Make sure the product is placed on even floor to prevent toppling hazard. It is recommended to place it against wall corner and use the included anti-toppling fittings to secure it to the wall.
Please place the product in the corner or against the wall. Do not place fragile
- items near the product.

Care Instructions

- Keep the product clean to prevent fleas, ticks, and mold.
- Use a hair remover for daily care. Do not clean with water or other liquid detergents. Always keep the product dry.
- Do not expose your cat tree to strong sunlight, which can cause discoloration, or to extreme heat, cold, or humidity, which can cause cat tree to swell or warp.
- If moisture does touch the wood surface, wipe immediately with a dry, soft cloth.

Product Material

- Board : particle board
- Fabric : plush fabric
- Cover Material : natural sisal rope

Suitable Load

1 to 3 cats

※ If the product is overloaded, there is a risk of damage

Dimensions

- Product Dimensions : 23.6"L x 14"W x 35.8"H
- Product Weight : 23.6 Lbs
- Package Dimensions : 14.6"L x 14.6"W x 13.4"H

Refund and Return Policy

Q&A:

- 1.Missing parts or accessories
- 2.Product damaged by lively and active Kitties
- 3.Receive wrong color
- 4.Not satisfied with the product

PLEASE DON'T WORRY !

Our professional customer service team is dedicated to ensuring you're 100% satisfied.

We highly appreciate you gain a pleasant shopping experience from our store and share it freely.







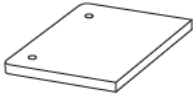
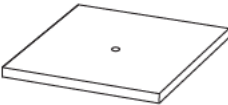

If have any problems related to the product occurred, please contact us at your earliest convenience. Our customer service will surely address your concerns in 24 hours.

Thanks for your great supports on us.We'll Always be There for You.

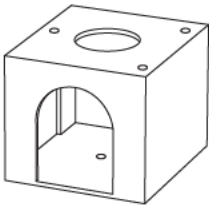
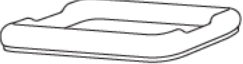
List

※ Before starting, inventory all hardware as stated on the assembly instructions.

<p>A × 1</p>  <p>250 x 350mm</p>	<p>B × 1</p>  <p>350 x 350mm</p>	<p>C × 1</p>  <p>350 x 350mm</p>
<p>D × 1</p>  <p>350 x 350 x 300mm</p>	<p>E × 1</p>  <p>350 x 350mm</p>	<p>F × 1</p>  <p>250 x 350mm</p>
<p>G × 1</p>  <p>300 mm</p>	<p>H × 1</p>  <p>200 mm</p>	<p>I × 2</p>  <p>200 mm</p>

※ Please note the orientation of the doors when assembling Part D to avoid mistakes.

List

P1

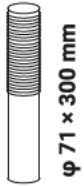

x 1

P2

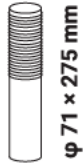

x 2

P3



x 4

P4

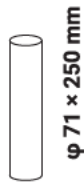

x 4

P5



x 1

P6

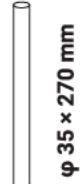

x 4

W1



x 1

W2



x 20

W3



x 6

W4



x 1

W5



x 1

Assembly Steps

Assembly Video



After scanning, you can watch our assembly video.
Hope it helps you.

Please scan the QR code

✘ For beauty, we "hide" the holes, they are surrounded by plush, sometimes you need to touch to find them.

1

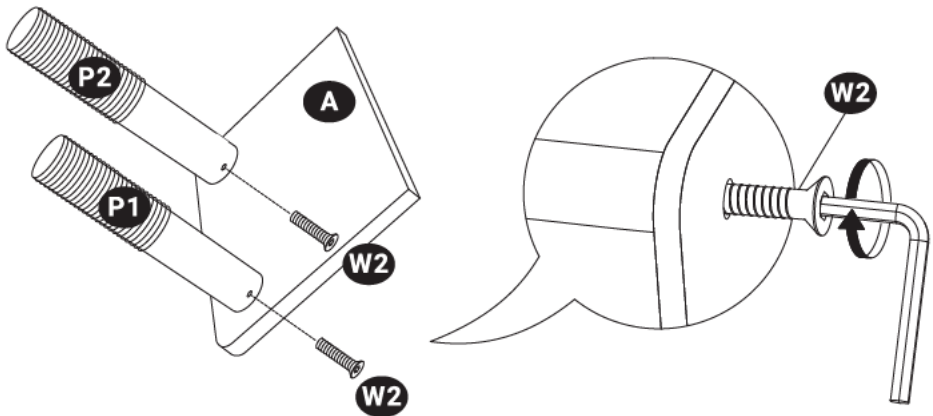

40mm **W2**  2 PCS

Assembly Steps

2

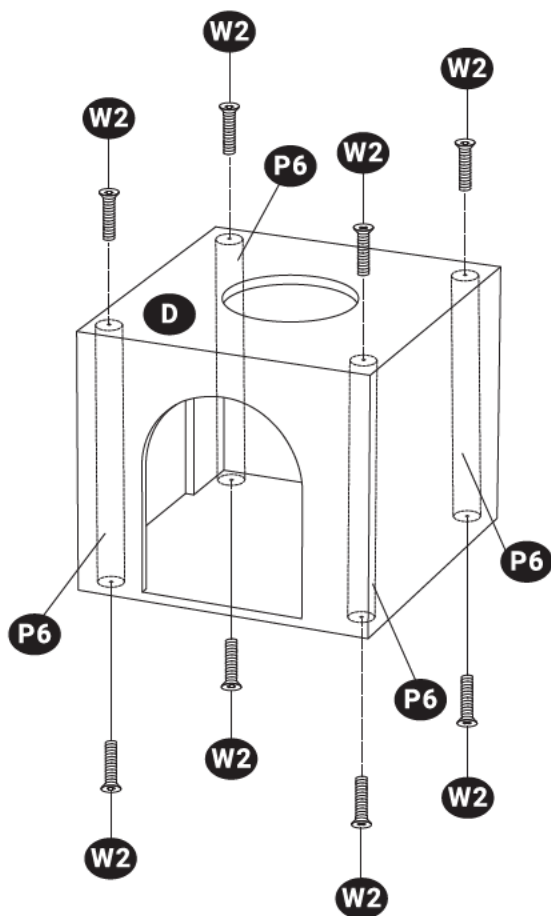

40mm **W2**  8 PCS

Assembly Steps

3

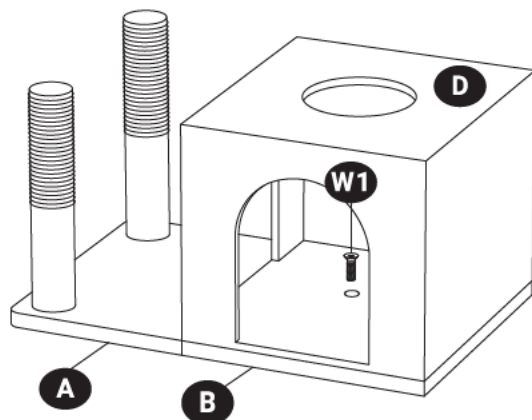

⚠ Note

Use W1 to fix Part D and Board B in place and then close to Board A.

30mm **W1**  1 PCS

4

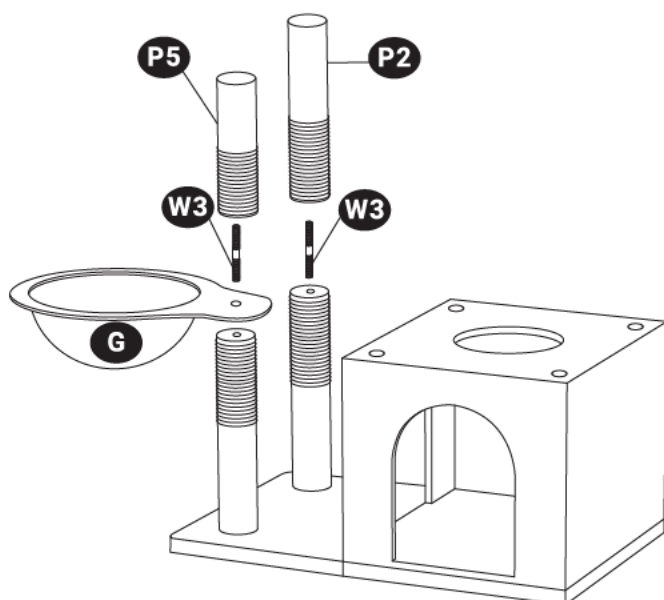

80mm **W3**  2 PCS

Assembly Steps

5

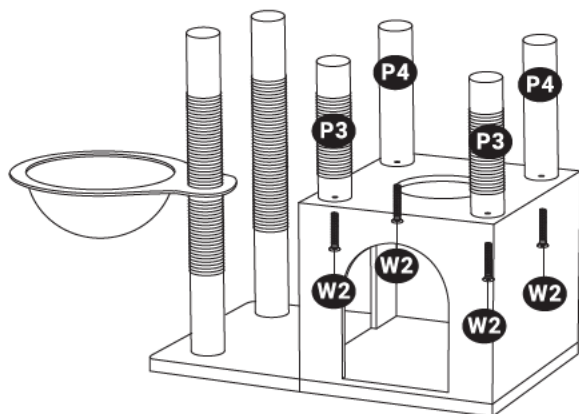

40mm **W2**  4 PCS

6

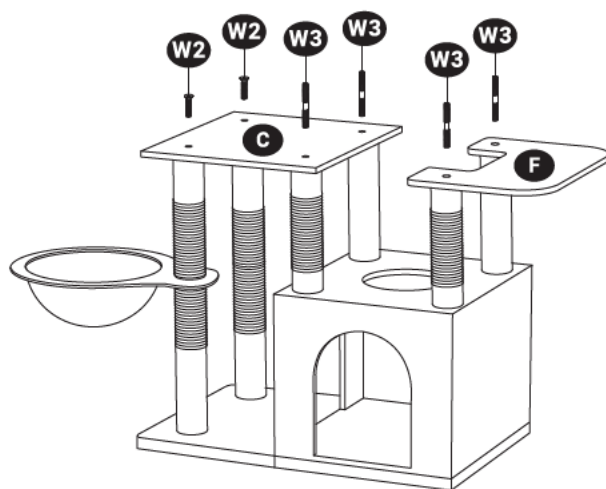

40mm **W2**  2PCS

80mm **W3**  4PCS

Assembly Steps

7

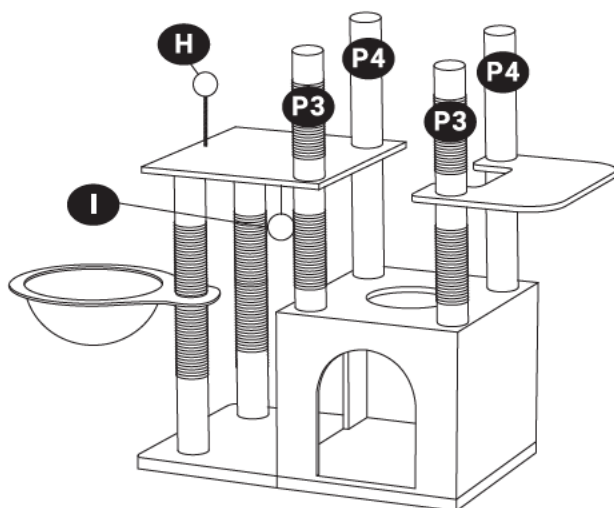

8

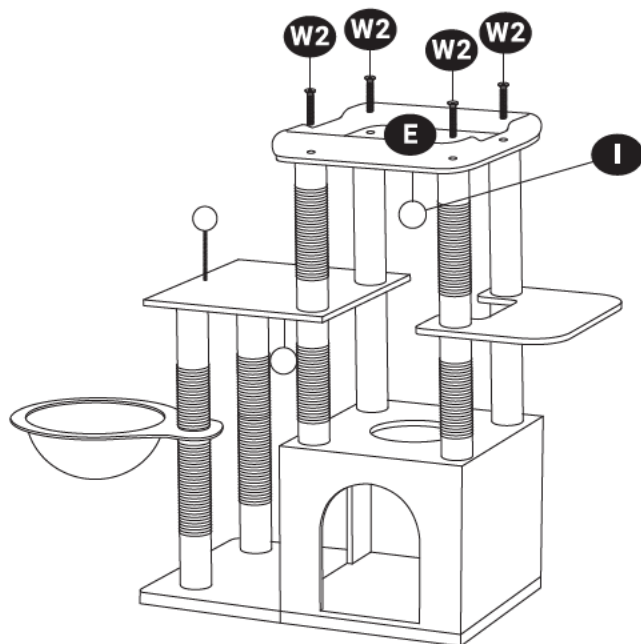

40mm **W2**  4 PCS

Assembly Steps

9

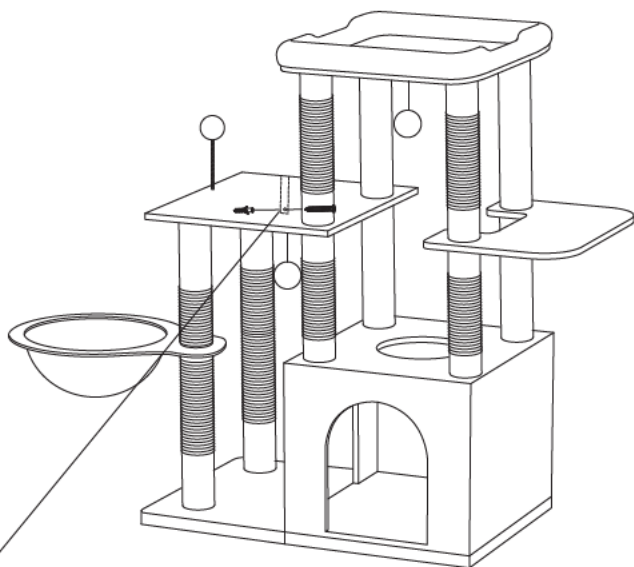
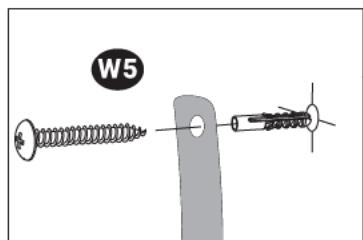
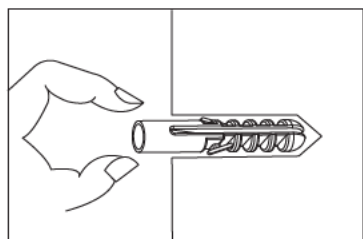
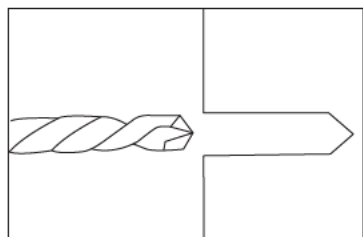

Optional : attach to the wall to prevent tipping.

W5



1PCS

Assembly Steps

- Even the box it comes in can be made to a cat box with a pair of scissors and some tape in just a few simple steps (scissors and tape are not included).

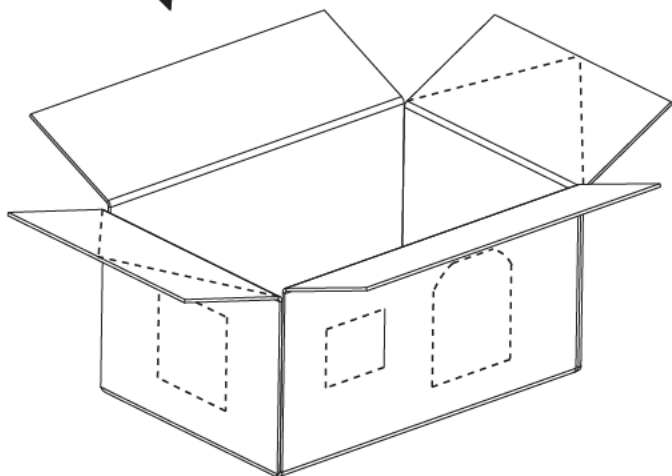
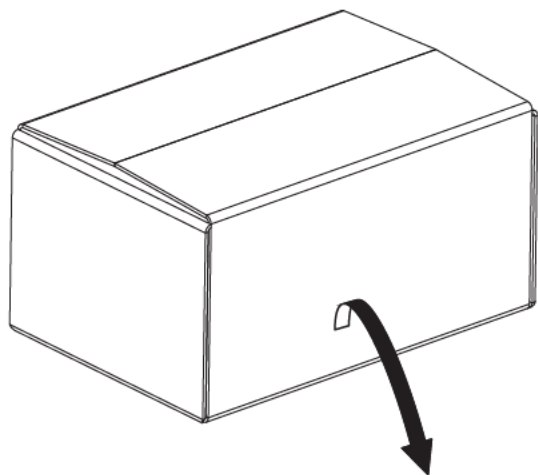

Assembly Steps

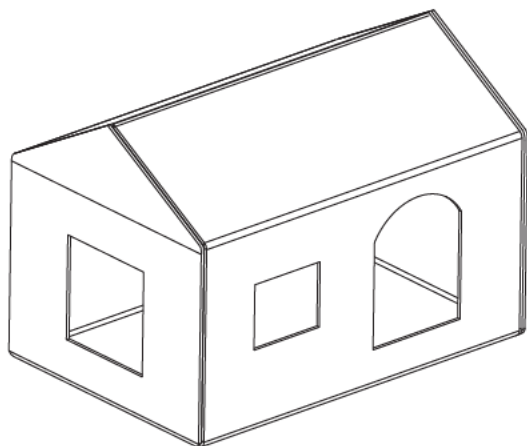
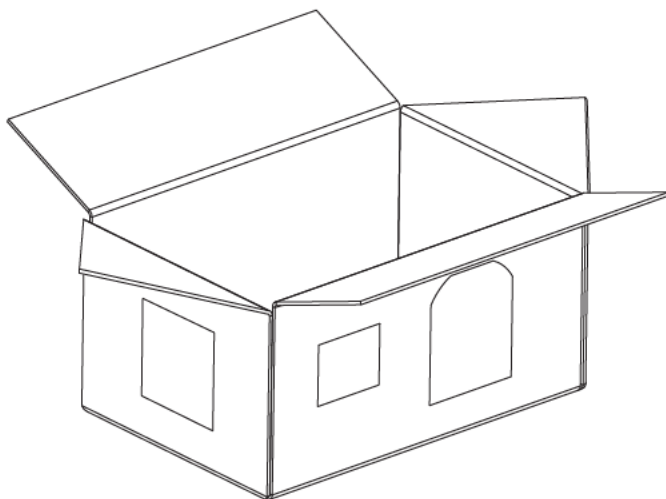

THANK YOU FOR YOUR GREAT SUPPORT ON US !



ANY PROBLEMS,PLEASE CONTACT US