









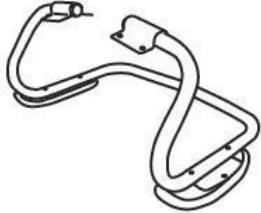

**IMPORTANT NOTICE:
HARDWARE PACKAGE IS ATTACHED
ON THE BOTTOM OF SEAT CUSHION.**

(1)  Back	(2)  Seat & Mechanism	(3)  Arm Frame
(4)  W/Casters	(5)  Knee Tilt Gas Lift	
(A)-4pcs  M6*30 BACK BAR SCREW	(B)-1pcs  M6*55 BACK SCREW	(C)-1pcs  CAP
(D)-8pcs  M6*25 ARM SCREW	(E)-1pcs  ALLEN KEY	

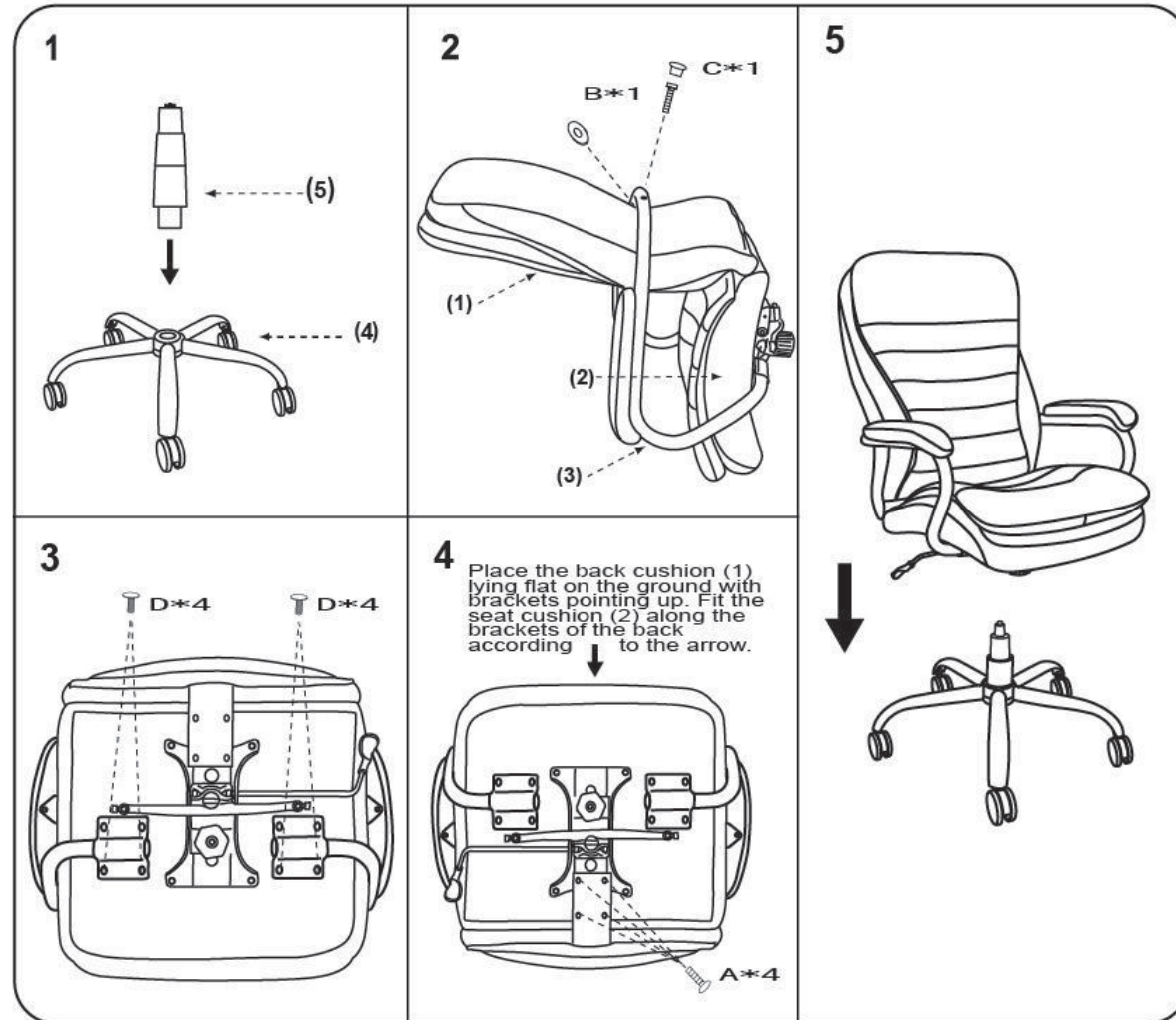

Insert and loosely tighten all screws. When assembly is completed, fully tighten all screws before using. This chair is only intended for sitting. Any other use will void the warranty.

For further assembly instructions, please visit our website