



LED	28W
	3.200lm
t	34W
T _K	1.200lm
	25.000 h
	3.000 K
	15.000 x
	<0,5s

230V/50Hz ~

1xLED-Board, 56V DC/28W

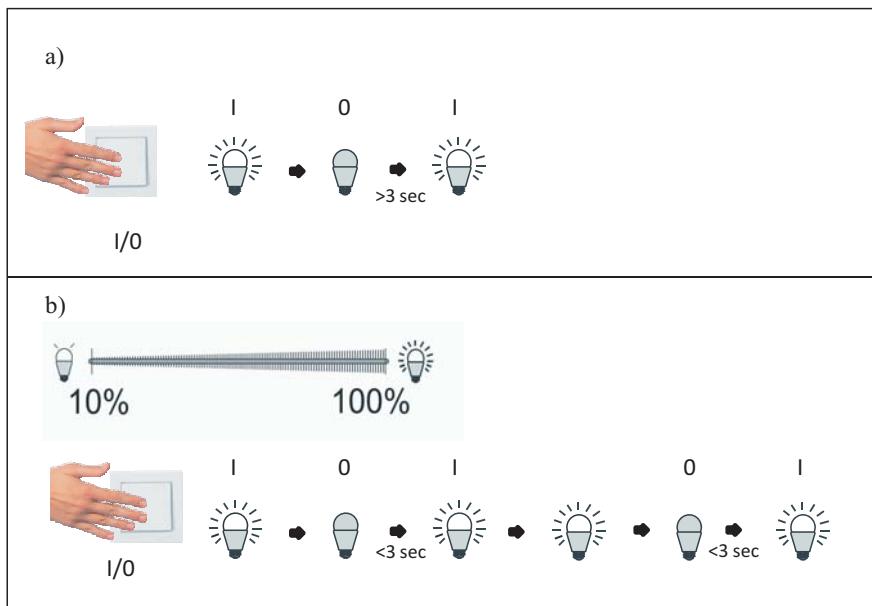
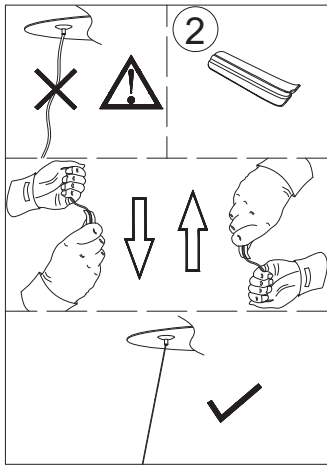
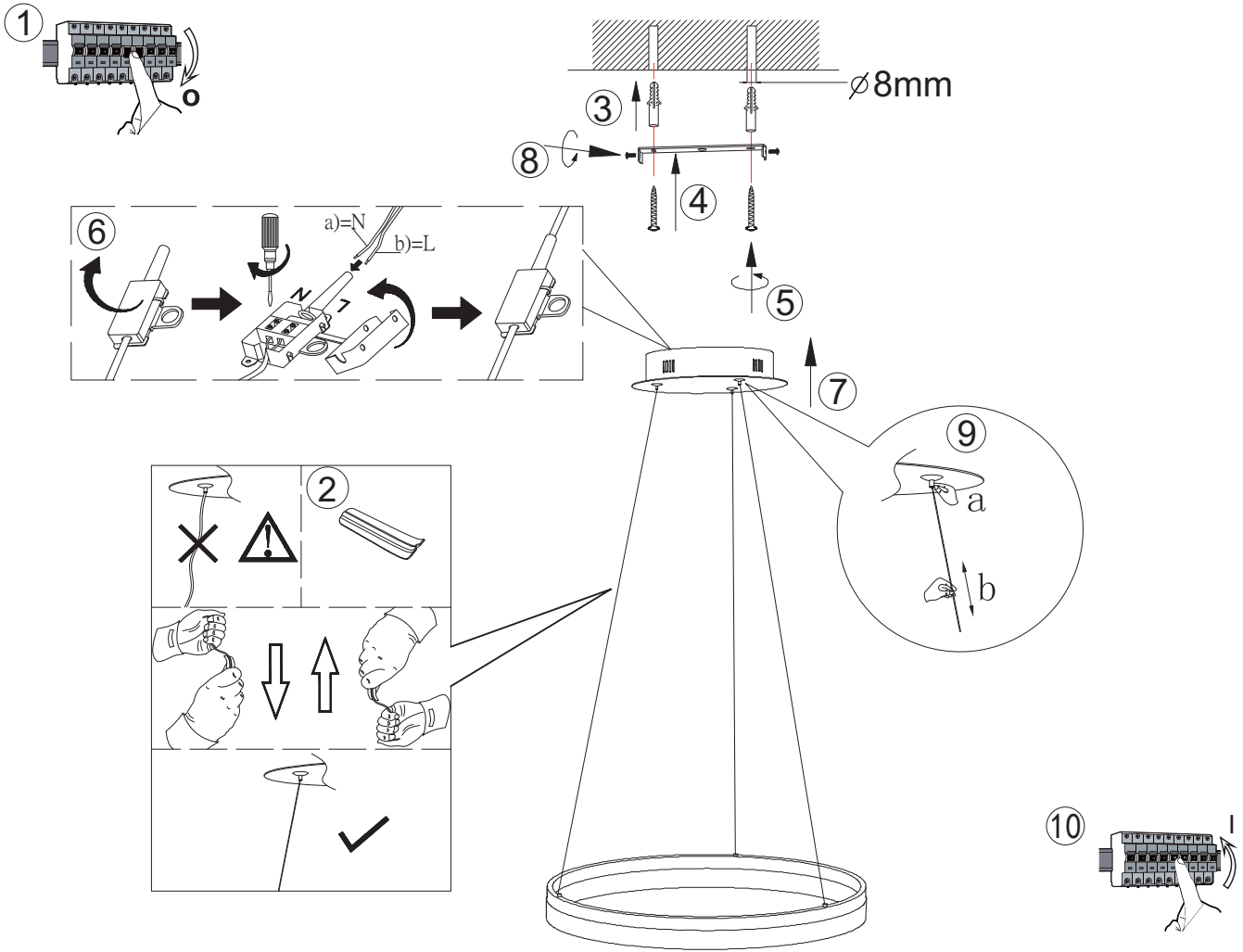

b)

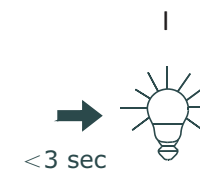
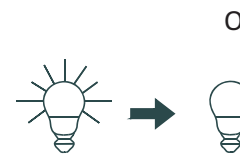
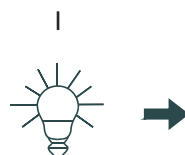
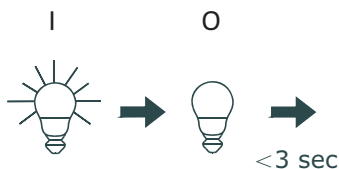

BG	функция на регулиране на светлинния поток
CZ	Funkce ztlumení
D	Dimm-Funktion
DK	Dæmpningsfunktion
E	Función reguladora
EST	Hämaduse funktsioon
F	Fonction variateur
FIN	Himmennyksen toiminto
GB	Dimmer function
GR	Λειτουργία μετρίασμού φωτισμού
H	Fénytompító funkció
HR	Funkcija prigušivanja
I	Funzione di regolazione
LT	Pritemdymo funkcija
LV	Spilgtuma samazināšanas funkcija
N	Dimmefunksjon
NL	Dimfunctie
P	Função de regulação de intensidade da luz
PL	Funkcja ściemniania
RO	Funcție de micșorare a luminii
RUS	функция диммирования
S	Dimfunktion
SK	funkcia stmievania
SLO	Funkcija zatemnitve
SRB	funkcija zatamnivanja
TR	Karartma fonksiyonu

BG	Лампата започва да регулира светлинния поток
CZ	Světlo se začne ztlumovat
D	Leuchte beginnt zu dimmen
DK	Lampen begynder at aftage i styrke
E	La lámpara comienza a regular
EST	Valgus hakkab hämaduma
F	La lumière commence à baisser
FIN	Valo alkaa himmentymään
GB	light starts to dim
GR	Το φως αρχίζει να εξασθενεί
H	A lámpa fénye tompulni kezd
HR	Svjetlo se počinje prigušivati
I	La luminosità inizia a ridursi
LT	Šviesos pritemsta
LV	Lampa sāk samazināt spilgtumu
N	Lysset begynner å dimme
NL	Lamp begint te dimmen
P	A lâmpada começa a regular a intensidade da luz
PL	Lampa zaczyna ściemniać się
RO	Lampa începe să reducă lumina
RUS	светильник плавно набирает яркость
S	Lampen börjar att dimra
SK	svietidlo sa začne stmievať
SLO	Svetilka prične zatemnjevat
SRB	svetiljka počinje da zatamnjuje
TR	Aydınlatma, kararmaya başlar

BG	Достигната желаната светлост
CZ	Dosaženo požadovaného jasu
D	gewünschte Helligkeit erreicht
DK	Nået ønsket lysstyrke
E	se alcanza la claridad deseada
EST	Soovitud heledus on saavutatud
F	atteint la luminosité souhaitée
FIN	Haluttu kirkkaus on saavutettu
GB	desired brightness attained
GR	Επίτευξη της επιθυμητής φωτεινότητας
H	A kívánt világosság elértve
HR	Željena svjetloća je postignuta
I	Raggiunge la luminosità desiderata
LT	Pasiekta norimas šviesumas
LV	Sasniegta nepieciešamā spilgtuma pakāpe
N	Lysset begynner å dimme
NL	Gewenste helderheid bereikt
P	O brilho pretendido foi atingido
PL	Pożądzany poziom jasności został osiągnięty
RO	Luminozitate dorită atinsă
RUS	желаемая яркость достигнута
S	Önskad ljusstyrka uppnådd
SK	dosiahnutý požadovaný jas
SLO	dosežena želena svetlost
SRB	postignuta željena osvetljenost
TR	İstenilen aydınlığa ulaşıldı

BG	Светлостта запаметена
CZ	Jas uložen
D	Helligkeit gespeichert
DK	Lysstyrke gemt
E	La claridad se almacena
EST	Heledus on salvestatud
F	Luminosité mise en mémoire
FIN	Kirkkaus on tallennettu
GB	brightness level saved
GR	Εξοικονόμηση φωτεινότητας
H	Világosság tárolva
HR	Pohranjena svjetloća
I	Luminosità salvata
LT	Šviesumas išsaugotas
LV	Spilgtuma pakāpe saglabāta
N	Lysset begynner å dimme
NL	Helderheid opgeslagen
P	Brilho está memorizado
PL	Zapisano poziom jasności
RO	Luminozitate memorată
RUS	яркость сохранена
S	Ljusstyrkan sparades
SK	jas uložený
SLO	svetlost shranjena
SRB	osvetljenost je memorisana
TR	Aydınlık kaydedildi