

East Grove

• H O M E •

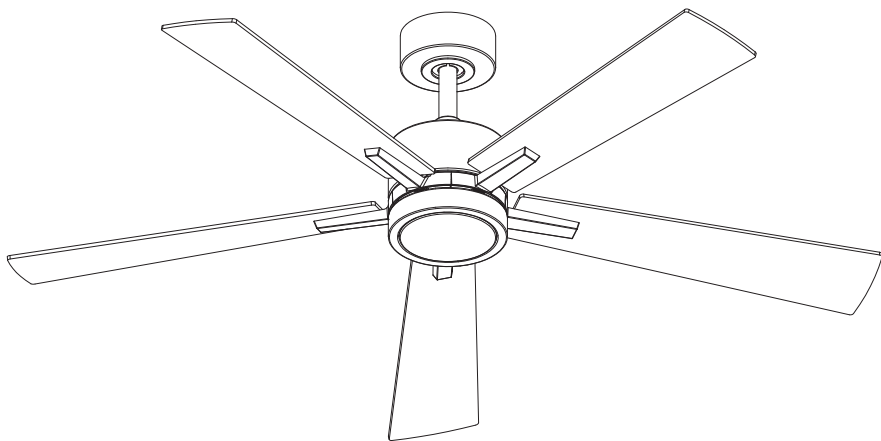

DOWNROD FAN **E-FR-042452L**

Installation Manual



Please read and
save these instructions
before installation

DO NOT RETURN TO STORE

General Inquiries

For all questions about your ceiling fan please read all included instructions, installation procedures, troubleshooting guidelines and warranty information before starting installation.

For fast service have the following information below when you call:

1. Model Name and Number
2. Part Number and Part Description
3. Date of Purchase and Purchase Location

1 (888) 602-0990

support@eastgrovehome.com

Safety Rules

For operation, maintenance, and troubleshooting information, visit <http://eastgrovehome.com>

To reduce the risk of electric shock, ensure electricity has been turned off at the circuit breaker before beginning. All wiring must be in accordance with the National Electrical Code “ANSI/NFPA 70” and local electrical codes. Electrical installation should be performed by a licensed electrician.

The fan must be mounted with a minimum of 7 ft. (2.1m) clearance from the trailing edge of the fan blades to the floor and a minimum of 1.5 ft (0.5m) from the edge of the fan blades to the surrounding walls. Never place objects in the path of the fan blades. To avoid personal injury or damage to the fan and other items, please be cautious when working around or cleaning the fan.

To avoid electrical shock or damage to the motor or finish, do not use water or chemicals when cleaning the fan or fan blades. A dry cloth or lightly dampened cloth will be suitable for most cleaning.

After making electrical connections, spliced conductors should be turned upward and pushed carefully up into the outlet box. The wires should be spread apart with the grounded conductor and the equipment-grounding conductor on one side of the outlet box, and the ungrounded conductor on the other side of the outlet box.

All set screws must be checked and re-tightened where necessary before installation.

WARNING: Do not install or use your fan if any part(s) is/are damaged or missing. This product is designed for use only with the supplied parts and/or accessories designated for use with this product by East Grove Home. Substitution of parts or accessories not designated for use with this product by East Grove Home could result in personal injury or property damage and will void the warranty. Contact an authorized dealer or the manufacturer if any parts are damaged or missing.

WARNING: To reduce the risk of electric shock, this fan must be installed and operated with the supplied wall control, or controlled from the East Grove Home app.

WARNING: Do not use power tools to assemble or install your fan. Using power tools can result in improper assembly which can lead to noise or fan damage, personal injury or property damage.

WARNING: To reduce the risk of personal injury, do not bend the blade arms when installing the brackets, balancing the blades or cleaning the fan.

WARNING: Do not insert foreign objects between rotating fan blades.

WARNING: Do not operate fan unless fan blades are in place. Noise and fan damage can occur

WARNING: This appliance is not intended for use by young children without supervision.

WARNING: To reduce the risk of fire, electric shock, personal injury or damage to the fan or other items, the outlet box and support structure must be securely mounted and capable of reliably supporting a minimum of 35 lbs (15.9 kg). Use only UL/cUL listed outlet boxes marked "FOR FAN SUPPORT." Use only the screws and washers provided with the outlet box.

WARNING: If unusual oscillating movement is observed, immediately stop using the ceiling fan and contact the manufacturer, its service agent or suitably qualified persons.

The Ceiling Fan suspension system should be examined at least once every two years.

The replacement of parts of the safety suspension system device shall be performed by the manufacturer, its service agent or suitably qualified persons.

WARNING: Ensure the wood beam's side is 1-inch wider than the canopy. The outlet box is to be sealed such that no water enters the outlet box.

WARNING: To Reduce The Risk Of Fire Or Electric Shock, Do Not Use This Fan With Any Solid-State Speed Control Device.

WARNING: To Reduce The Risk Of Fire, Electric Shock Or Injury To Persons, Do Not Use Replacement Parts That Have Not Been Recommended By The Manufacturer (e.g. Parts Made At Home Using A 3D Printer).

WARNING: This appliance is not intended for use by persons (including children) with reduced physical, sensory or mental capabilities, or lack of experience and knowledge, unless they have been given supervision or instruction concerning use of the appliance by a person responsible for their safety.

WARNING: Children should be supervised to ensure that they do not play with the appliance.

WARNING: The mounting of the suspension system shall be performed by the manufacturer, its service agent or suitably qualified persons.

WARNING: The fixing means for attachment to the ceiling shall be fixed with a sufficient strength to withstand 4 times the weight of the ceiling fan.

WARNING: To Reduce The Risk Of Electric Shock, This Fan Must Be Installed With An Isolating Wall Control/Switch.

WARNING: Means for disconnection must be incorporated in the fixed wiring in accordance with the wiring rules.



CAUTION: Before assembling your fan, refer to the "Making the Electrical Connections" section. If you feel you do not have enough wiring knowledge or experience, have your fan installed by a licensed electrician.

NOTE: Before servicing or cleaning the fan, switch power off at the circuit breaker.

Controls and Features

Integrates seamlessly
with Smart Life App

Available at



Wi-Fi enabled
for flexible control

Traditional control with
included remote

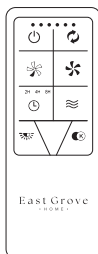

Contents

Package Contents	8
Mounting Options	10
Installing Mounting Bracket.	12
Assembling the Fan Housing	14
Assembling fan Blades	16
LED Module	18
Hanging the Fan	19
Electrical Connections	20
Finishing Installation	22
Operating the Fan	23

Tools Required

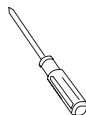





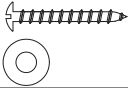

Package Contents

1. Blades
2. Hanging Bracket/Downrod Assembly
3. Canopy & Canopy Screw Ring
4. Coupling Cover
5. Motor Housing
6. Blade Arms
7. LED Module
8. Acrylic Shade
9. Receiver
10. Remote Control

Hardware Bag

Hardware Bag 

A	Machine Screws (2pcs) Flat Washers (2pcs)	
B	Wood Screws (2pcs) Flat Washers (2pcs)	
C	Blade Screws (10pcs) Fiber Washers (10pcs)	
D	Blade Holder Screws with Washers (7pcs)	
E	Wire Nuts (4pcs)	
F	Balance Block (3pcs)	
G	Metal Light Cover Screw (1 Extra)	



Before discarding packaging materials be certain all parts have been removed.
Place the parts from the hardware bag into a small container to keep them from being lost.

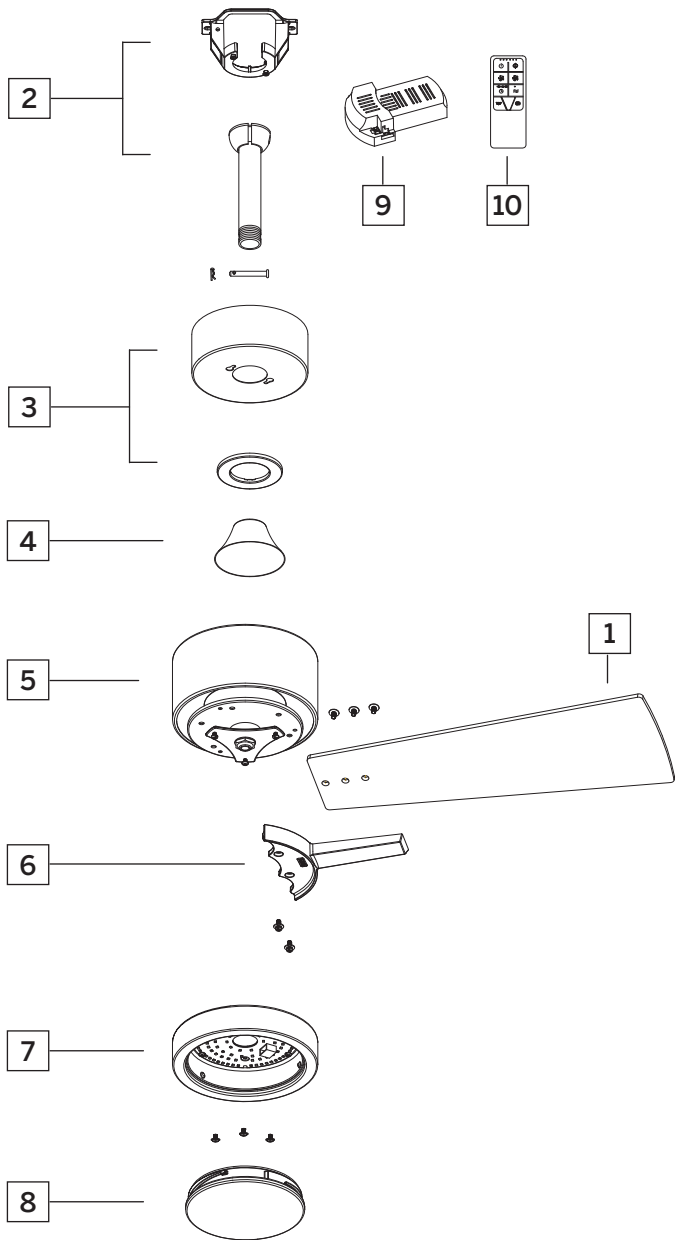

1. Mounting Options



CAUTION: To prevent electrical shock, ensure electricity has been turned off at the circuit breaker before beginning.

If there isn't an existing UL/cUL listed outlet box, please refer to the following instructions. Secure the outlet box directly to the building structure. Use appropriate fasteners and building materials. The outlet box and support structure must be able to fully support the moving weight of the fan (at least 50 lbs. or less 22.7 kg). Do not use plastic outlet boxes. Use only UL/cUL listed outlet boxes marked "FOR FAN SUPPORT."

Secure the outlet box directly to the building structure. Use Part A if needed to mount the outlet box.

Figures 1-1B are examples of different ways to mount the outlet box.

NOTE: To hang your fan where there is an existing fixture but no ceiling joist, you may need an installation hanger bar.

1

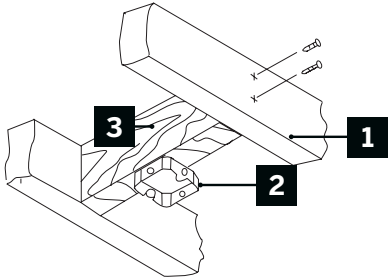

1. Support Brace
2. Outlet Box
3. Joist

1A

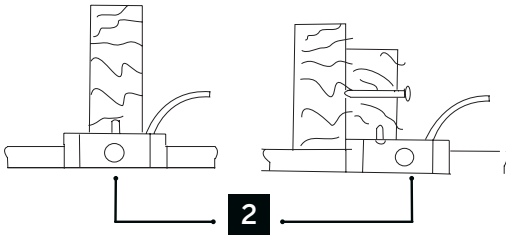

1B

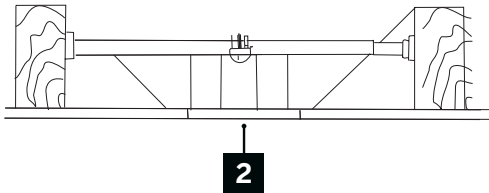

2. Installing the Mounting Bracket

Remember to disconnect the power at the circuit breaker.

1. Loosen 2 screws from the bottom of the mounting bracket, for later use in the installation.
2. Pass the 120-volt supply wires through the center hole in the mounting bracket as shown (Fig. 2A).
3. Secure the mounting bracket to the ceiling outlet box with the screws and washers provided with your outlet box. Use Part A if needed to mount your Outlet Box.

NOTE: Make sure that mounting screws are tight.

2A

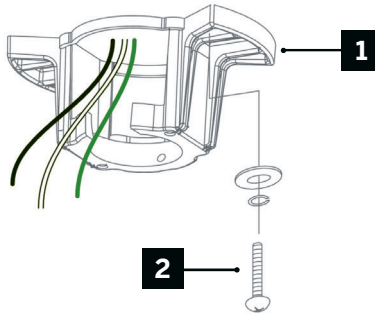

1. Mounting Bracket
2. Screw

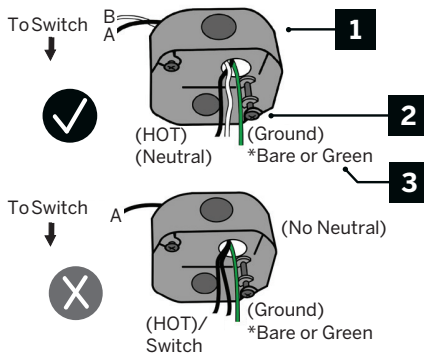

1. cUL/UL Listed Outlet Box
2. Mounting Screws
(outlet box screws not included)
3. 120V Wires

3. Assembling the Fan

1. Remove tension screw attached to ball joint of the Downrod Assembly and remove the cotter pin (Fig. 3A).
2. On a flat surface, feed Downrod Assembly through the Canopy, Canopy Cover, Canopy Cone and Canopy Ring (Fig. 3B).
3. Remove safety foam packaging from Motor.
4. Feed the wires up from the Motor, completely through the Downrod Assembly.
5. Reinstall the cotter pin and tension screw.
6. Loosen screws on Motor Housing (Fig. 3C).
7. Align Downrod and motor collar holes, re-insert pins and screws (Fig. 3D).
8. Retighten screws from Step 6.

3A

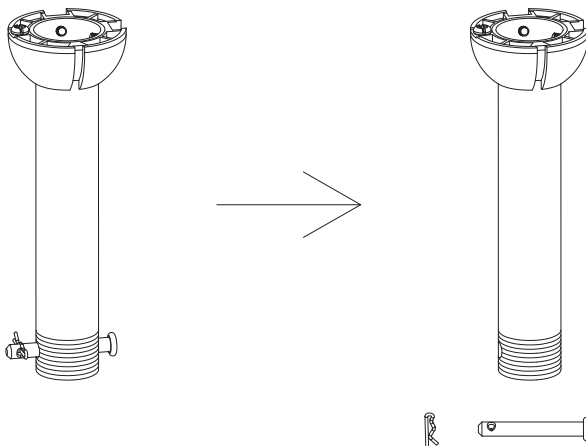

3B

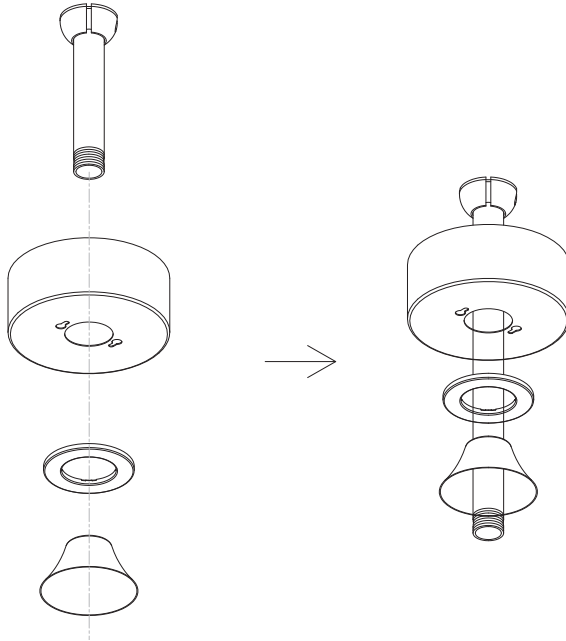

3C



3D

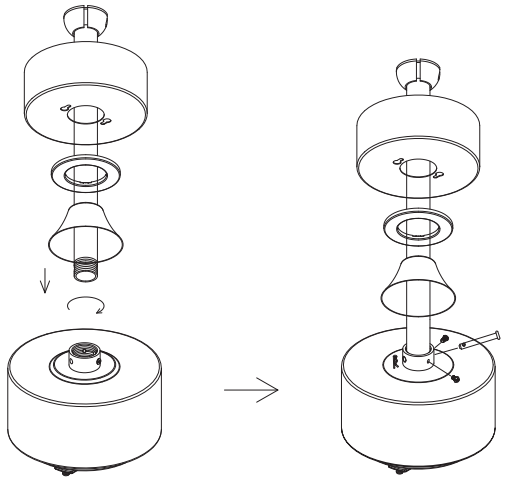

4. Attaching the Fan Blades

1. Place assembled fan housing upside down, vertically on a flat surface.
-Do not rest fan housing on top of wires below.
2. Attach Fan Blade Arms to the Blades using the screws with red washers attached (Fig 4A).
3. Depending on finish options, you may choose which side of the fan blade will be visible at this time.
4. Attach blade arms to housing, using the provided screws with metal washers (Fig 4B).

4A

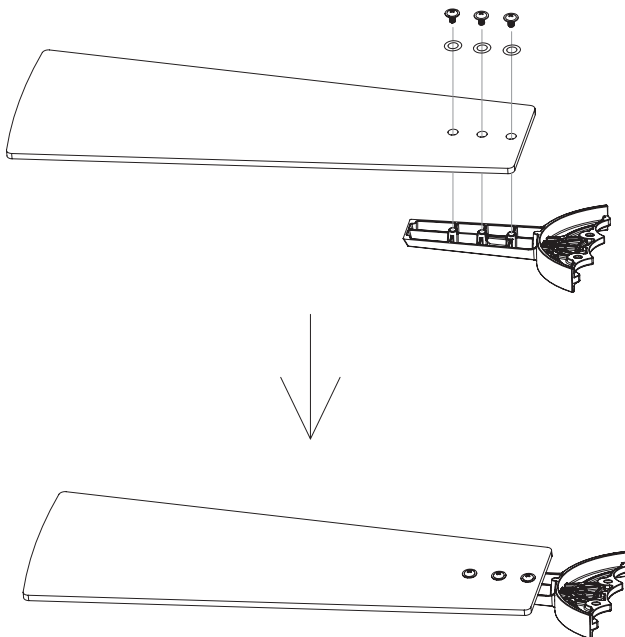

4B

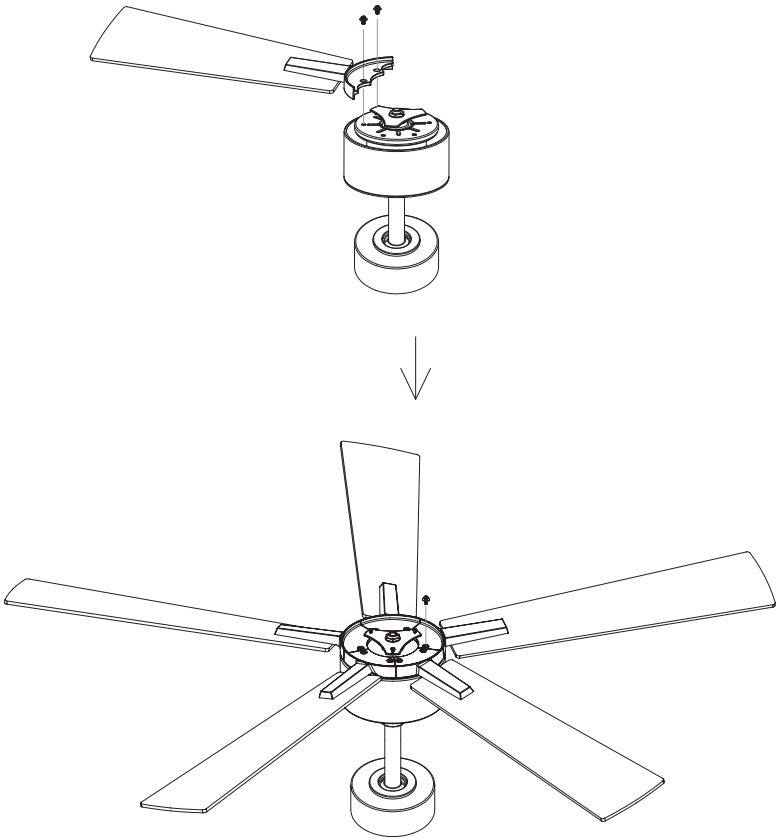

5. Installing the LED Module / PC Shade

1. Remove the 3 screws from the adapter plate (Fig. 5A).
2. Align 3 holes in LED Module with the adapter plate, and secure using the 3 screws from Step 1.
3. Attach LED wires from motor assembly to LED Module (Fig. 5B).
4. Install the shade by twisting it into place. Make sure it is on tight. (Fig. 5C).

5A

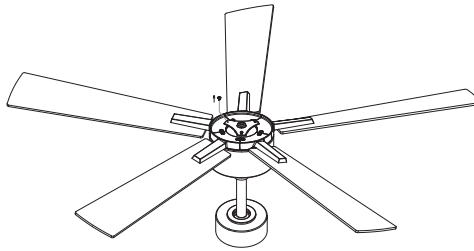

5B

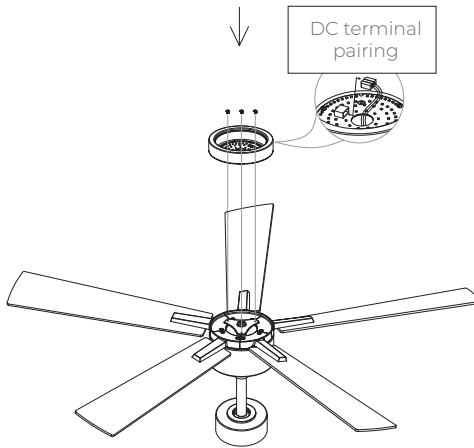

5C

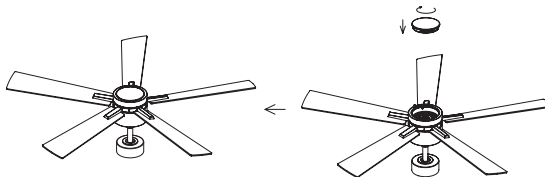

6. Hanging the Fan

1. Carefully rotate the fan right-side up.
2. Slide ball end of Downrod Assembly into the mounting bracket.
3. Align notch in bracket with groove in the downrod assembly (Fig. 6A).

6A

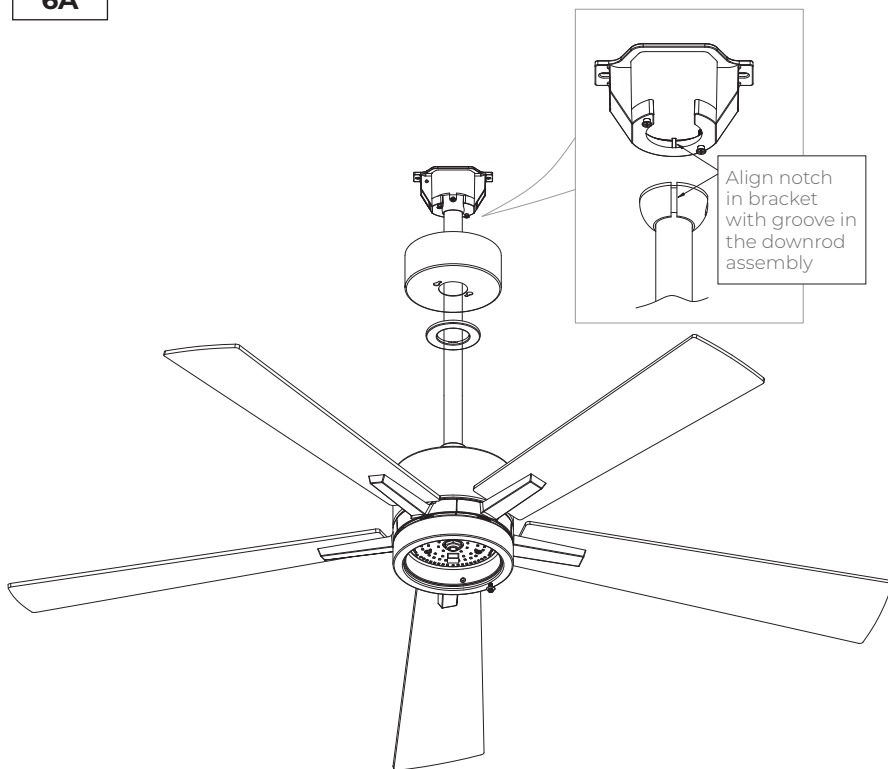

7. Making the Electrical Connections

⚠ WARNING: Installation of this fan requires that a three-conductor cable (including ground wire) which should run between ceiling and wall outlet box. Use provided wirenuts.

⚠ WARNING: Check to see that all connections are tight, including ground, and that no bare wire is visible at the wire nuts, except for the ground wire.

Insert the receiver into the mounting bracket as shown (Fig. 7A).

NOTE: Failure to make correct wire connections can permanently damage the receiver. Make certain you follow the below steps and diagram.

Motor to Receiver & Receiver to house supply wires (Fig. 7B).

1. Connect the fan assembly ground wire, mounting bracket ground wire, and receiver ground wire to the ground wire in the outlet box.

⚠ WARNING: Failure to connect ground wires could result in poor fan control functionality.

2. Connect the black (hot) wire from the ceiling to the black wire marked "AC in L" from the receiver.
3. Connect the white (neutral) wire from the ceiling to the white wire marked "AC in N" from the receiver.
4. Connect the quick connect from the fan to the slot marked "TO MOTOR" from the receiver.
5. Connect the quick connect from the fan to the slot marked "TO LIGHT" from the receiver.

7A

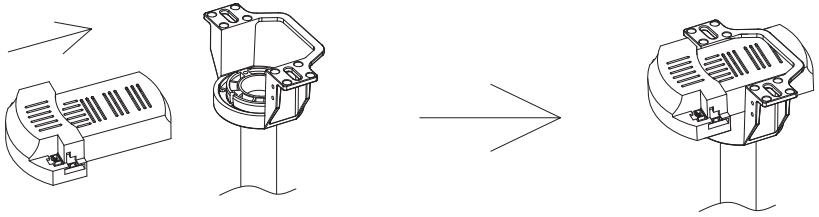

7B

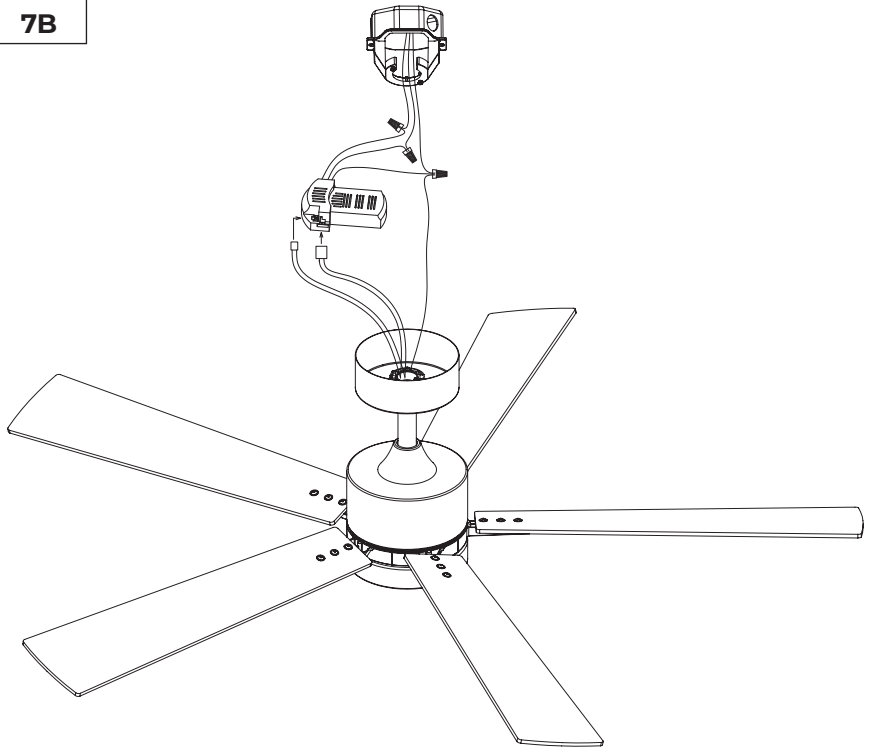

8. Finishing the Installation

1. Align canopy holes with the screws and secure to mounting bracket (Fig. 8A). Note: These screws may need to be slightly loosened first, to allow placement of canopy.
2. Install canopy screw ring as shown (Fig. 8B).

8A

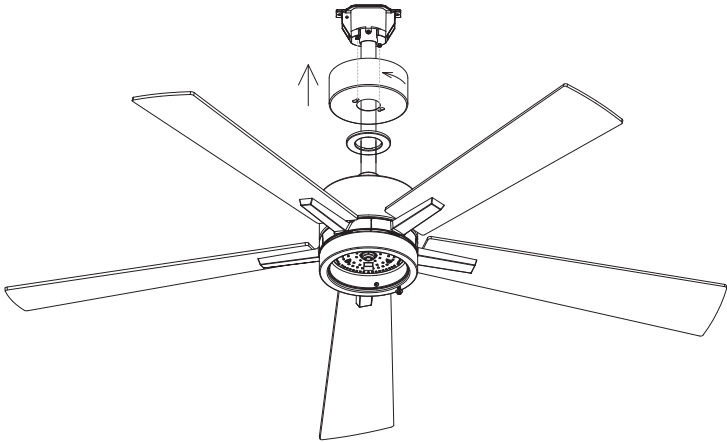

8B

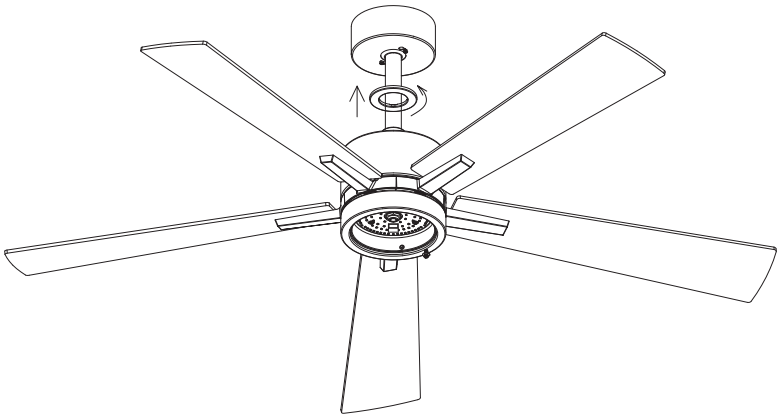

9. Operating the Fan

The included remote control may need to be paired with the fan.

1. Press and hold OFF button for 10 seconds (Fig 9A). The fan will beep once after it successfully pairs with remote.

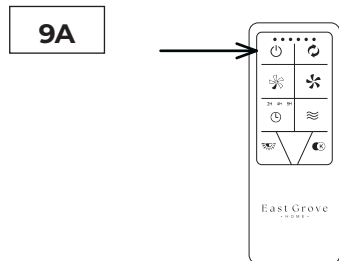

See Fig. 9B for remote functions

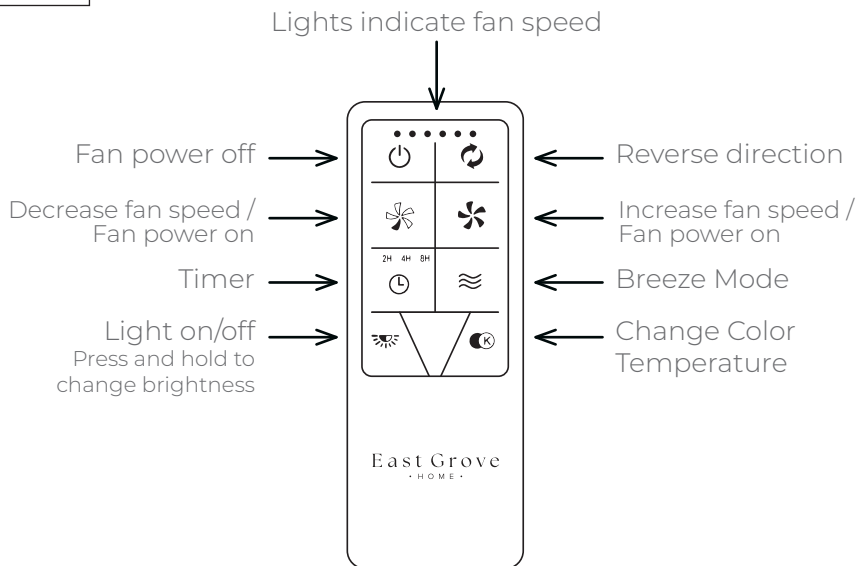
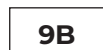

Summer / Winter Modes

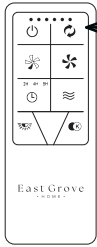

Press once to reverse blade spin

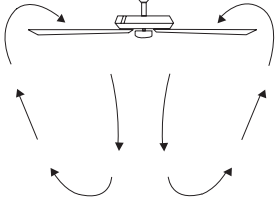

Summer Mode
(Counter-Clockwise)

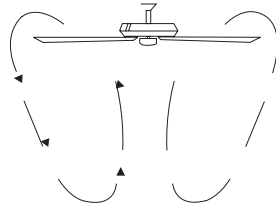

Winter Mode
(Clockwise)

Color Temperature



Press once to toggle color temperature ranging from 2700K to 6000K

Certificate of Warranty

Congratulations on your new purchase.

Your new East Grove Home Smart Fan is engineered to make life easier every day. East Grove Home creates future-forward fans and luminaires that provide energy savings and outstanding efficiency. Our dedication to doing things the right way goes beyond our love for amazing products. East Grove Home Smart Fans™ warrants any of its outdoor rated ceiling fan products that they are to be free from defects in material and workmanship for a period of one (1) year from the date of purchase; outdoor painted finishes are warranted for two (2) years; LED light modules and electronic components are warranted for five (5) years; DC motors and stainless steel finishes are warranted for lifetime under normal use to the first non-dealer purchaser.

Although East Grove Home uses the best available materials and does extensive testing for finish endurance, some fading or chalking may occur and is considered normal. For coastal locations, some corrosion and/or deterioration is considered "normal wear" in this environment. Therefore, any finish claim due to coastal environment conditions is not applicable to our warranty. If a product is defective, all efforts will be made to correct the problem in the field. If the problem cannot be resolved, an RGA number will be issued. East Grove Home obligation is expressly limited to repair or replacement, without charge, at the East Grove Home factory after prior written return authorization has been granted. East Grove Home obligation under this warranty shall not extend beyond the distributor's initial purchase price of the product and accordingly any consequential damages or labor costs arising out of a defect are expressly excluded. This warranty shall not apply to products that have been altered, improperly installed, mishandled or misused. Notice of a defect in writing must be received by East Grove Home within five (5) years from the date of purchase (or according period of time as outlined by material). Excluded from warranty are any 3rd party component which carries its own manufacturer's warranty. Note: East Grove Home product warranty applies only to purchases from authorized East Grove Home distributors. THERE ARE NO WARRANTIES WHICH EXTEND BEYOND THE DESCRIPTION ON THE FACE HEREOF INCLUDING WARRANTIES OF MERCHANTABILITY AND FITNESS FOR A PARTICULAR PURPOSE. The Bluetooth® word mark and logos are registered trademarks owned by Bluetooth SIG, Inc. and any use of such marks by East Grove Home is under license. Other trademarks and trade names are those of their respective owners.

Felicidades por tu nueva compra.

Su nuevo ventilador East Grove Home modernas está diseñado para facilitarle la vida cada día. East Grove Home crea ventiladores y luminarias para el futuro que proporcionan ahorros de energía y eficiencia excepcional. Nuestra dedicación a hacer las cosas de la manera correcta va más allá de nuestro amor por los productos asombrosos. East Grove Home garantiza a cualquiera de sus productos para ventiladores de techo con clasificación exterior que estén libres de defectos en materiales y mano de obra por un período de un (1) año desde el fecha de compra; Los módulos de luz LED están garantizados por cinco (5) años; Los motores de CC y los acabados de acero inoxidable están garantizados de por vida bajo el uso normal para el primer comprador no distribuidor.

Aunque East Grove Home utiliza los mejores materiales disponibles y realiza pruebas exhaustivas para la resistencia del acabado, puede producirse cierto desvanecimiento o parloteo y se considera normal. Para las ubicaciones costeras, cierta corrosión y / o deterioro se considera "desgaste normal" en este entorno. Por lo tanto, cualquier reclamación de acabado debido a las condiciones del entorno costero no se aplica a nuestra garantía. Si un producto es defectuoso, se harán todos los esfuerzos para corregirlo. El problema en el campo. Si el problema no se puede resolver, se emitirá un número RGA. La obligación de East Grove Home se limita expresamente a la reparación o el reemplazo, sin cargo, en la fábrica de East Grove Home después de que se haya otorgado una autorización previa por escrito.

La obligación de East Grove Home bajo esta garantía no se extenderá más allá del precio de compra inicial del producto por parte del distribuidor y, en consecuencia, cualquier daño consecencial o costo de mano de obra que surja de un defecto se excluye expresamente. Esta garantía no se aplicará a los productos que hayan sido alterados, instalados incorrectamente, mal manejados o mal utilizados. La notificación de un defecto por escrito debe ser recibida por East Grove Home dentro de los cinco (5) años a partir de la fecha de compra (o según el período de tiempo indicado en el material). Quedan excluidos de la garantía todos los componentes de terceros que tengan la garantía de su propio fabricante. Nota: la garantía del producto East Grove Home se aplica solo a las compras de los distribuidores autorizados de East Grove Home. NO HAY GARANTÍAS QUE SE EXTIENDAN MÁS ALLÁ DE LA DESCRIPCIÓN DE SU CARACTERÍSTICA, INCLUIDAS LAS GARANTÍAS DE COMERCIALIZACIÓN Y ADECUACIÓN PARA UN PROPÓSITO PARTICULAR. La marca denominativa y los logotipos Bluetooth® son marcas registradas propiedad de Bluetooth SIG, Inc. y cualquier uso de dichas marcas por parte de East Grove Home se realiza bajo licencia. Otras marcas comerciales y nombres comerciales pertenecen a sus respectivos propietarios. obligación de East Grove Home bajo esta garantía no se extenderá más allá del precio de compra inicial del producto por parte del distribuidor y, en consecuencia, cualquier daño consecencial o costo de mano de obra que surja de un defecto se excluye expresamente. Esta garantía no se aplicará a los productos que hayan sido alterados, instalados incorrectamente, mal manejados o mal utilizados. La notificación de un defecto por escrito debe ser recibida por East Grove Home dentro de los cinco (5) años a partir de la fecha de compra (o según el período de tiempo indicado en el material). Quedan excluidos de la garantía todos los componentes de terceros que tengan la garantía de su propio fabricante. Nota: la garantía del producto East Grove Home se aplica solo a las compras de los distribuidores autorizados de East Grove Home. NO HAY GARANTÍAS QUE SE EXTIENDAN MÁS ALLÁ DE LA DESCRIPCIÓN DE SU CARACTERÍSTICA, INCLUIDAS LAS GARANTÍAS DE COMERCIALIZACIÓN Y ADECUACIÓN PARA UN PROPÓSITO PARTICULAR. La marca denominativa y los logotipos Bluetooth® son marcas registradas propiedad de Bluetooth SIG, Inc. y cualquier uso de dichas marcas por parte de East Grove Home se realiza bajo licencia. Otras marcas comerciales y nombres comerciales pertenecen a sus respectivos propietarios.

Félicitations pour votre nouvel achat.

Votre nouveau ventilateur intelligent East Grove Home est conçu pour vous simplifier la vie au quotidien. East Grove Home crée des ventilateurs et des luminaires d'avant-garde qui permettent des économies d'énergie et une efficacité exceptionnelle. Notre engagement à bien faire les choses va au-delà de notre amour pour les produits étonnants. East Grove Home garantit à tous ses produits pour ventilateurs de plafond pour extérieur qu'ils ne doivent présenter aucun défaut de matériau ou de fabrication pendant un (1) an date d'achat; Les modules d'éclairage à LED sont garantis pendant cinq (5) ans; Les moteurs à courant continu et les finis en acier inoxydable sont garantis à vie dans les conditions normales d'utilisation par le premier acheteur non revendeur.

Bien que East Grove Home utilise les meilleurs matériaux disponibles et effectue des tests approfondis pour l'endurance de la finition, des décolorations ou des craies peuvent se produire et sont considérés comme normaux. Pour les zones côtières, une certaine corrosion et / ou détérioration est considérée comme une «usure normale» dans cet environnement. Par conséquent, toute réclamation liée à la finition en raison des conditions de l'environnement côtier ne s'applique pas à notre garantie. Si un produit est défectueux, tous les efforts seront déployés pour y remédier. Le problème sur le terrain. Si le problème ne peut pas être résolu, un numéro RGA sera attribué. L'obligation de East Grove Home est expressément limitée à la réparation ou au remplacement, sans frais, dans l'usine de East Grove Home après autorisation écrite préalable du retour. L'obligation de East Grove Home au titre de cette garantie ne s'étendra pas au-delà du prix d'achat initial du produit par le distributeur. En conséquence, tout dommage indirect ou tout coût de main-d'œuvre résultant d'un défaut est expressément exclu. Cette garantie ne s'applique pas aux produits modifiés, mal installés, manipulés ou utilisés de manière inappropriée. East Grove Home doit recevoir un avis écrit du défaut dans un délai de cinq (5) ans à compter de la date d'achat (ou selon la période précisée dans les informations fournies). Sont exclus de la garantie tout composant tiers bénéficiant de la garantie du fabricant. Remarque: la garantie des produits East Grove Home ne s'applique qu'aux achats auprès des distributeurs agréés East Grove Home. IL N'Y A AUCUNE GARANTIE QUI ALLAIT AU-DELÀ DE LA DESCRIPTION FACE AU PRESENT, INCLUANT LES GARANTIES DE QUALITÉ MARCHANDE ET D'ADÉQUATION À UN USAGE PARTICULIER. La marque et les logos Bluetooth® sont des marques déposées appartenant à Bluetooth SIG, Inc. et toute utilisation de ces marques par East Grove Home est sous licence. Les autres marques et noms commerciaux appartiennent à leurs propriétaires respectifs.

East Grove

• H O M E •



Smart Life - Smart Living

App Instruction Manual

Available at:



Pairing East Grove Home ceiling fan with mobile device using the Smart Life App

Bluetooth must be enabled on the mobile device and connected to WIFI at location of the fan

East Grove

• HOME •

1 Register and sign in your account of Smart Life APP, press "Add Device" button

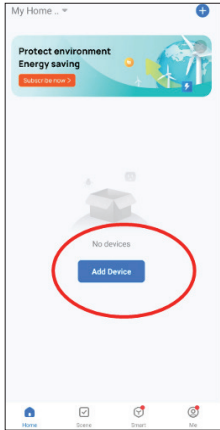

2 Turn on the Bluetooth function of the mobile device

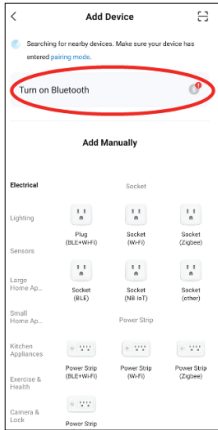

3 Press and hold the 8H button on the remote until you hear a long beep sound, then go to next step



4 Press "Add" button to discover the device

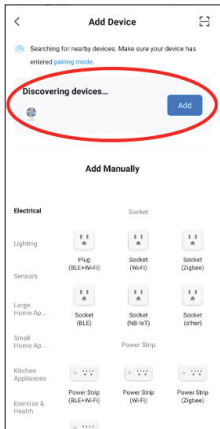

5 Select 2.4G WIFI and enter password
Note: only 2.4G WIFI compatible

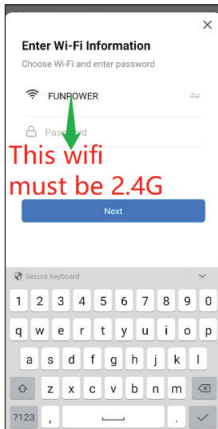

6 Confirmation device has been added successfully

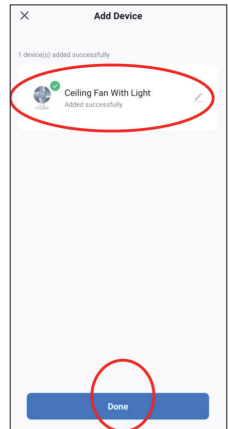

Ceiling Fan Control with Smart Life App

East Grove
• HOME •

1

From home screen, select ceiling fan to control

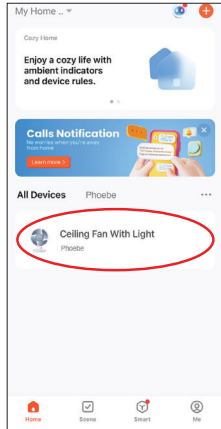

2

Select the power icon labeled "Switch" to start fan blade spin

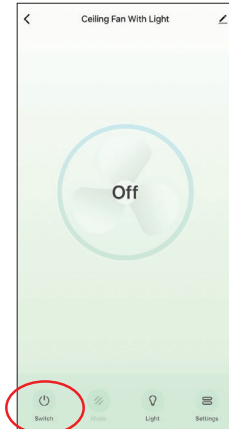

3

To adjust fan speed, slide the speed indicator to your desired speed

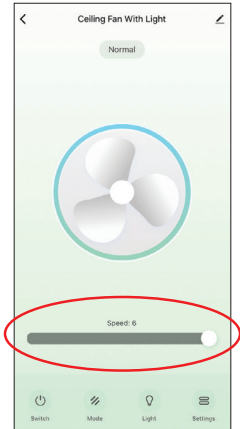

4

Select "Mode" to access Normal, Sleep, and Natural modes. By default, fan is in Normal mode.

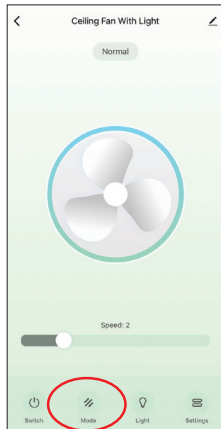

5

With "Natural", fan speed will switch from 1 to 6 intermittently, to create breeze-like effect. Tap "Done" to confirm desired setting

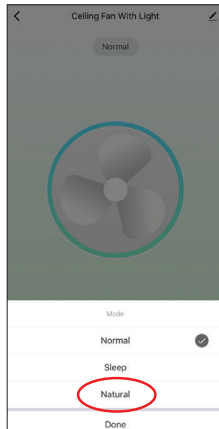

6

Select "Settings" to access fan forward/reverse spin direction and automatic timer setting

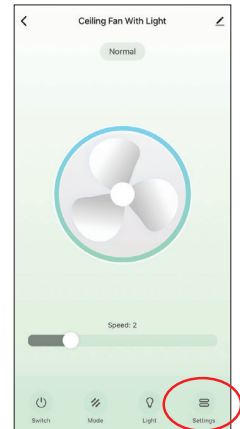

Ceiling Fan Control with Smart Life App

East Grove
• HOME •

7

Under Settings, Fan Direction, choose forward or reverse. Tap "Done" to confirm desired setting

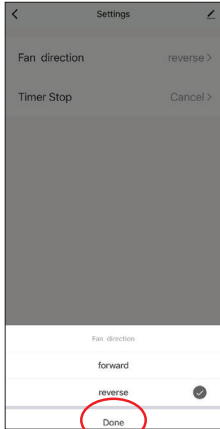

8

Under Settings, Timer Stop, select time for fan to shut off. Tap "Done" to confirm desired setting

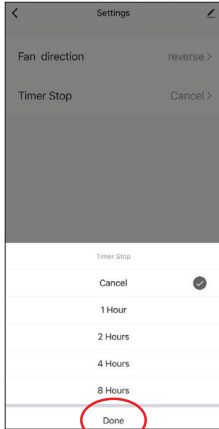

9

To turn light on/off and access light settings, select "Light"

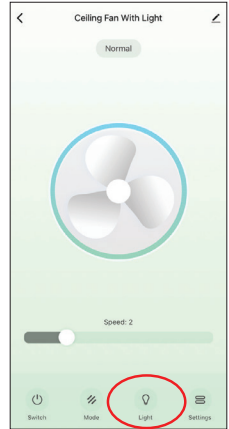

10

Toggle switch to turn light on and off

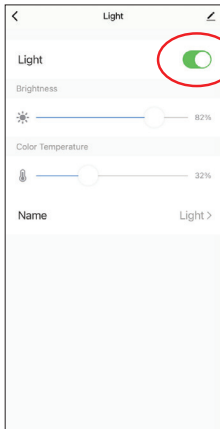

11

To increase LED brightness, slide the indicator to the RIGHT. Slide LEFT to dim

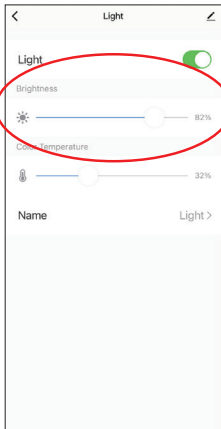

12

Slide indicator from LEFT to RIGHT to choose from 2700K Warm White to 6000K Cool White

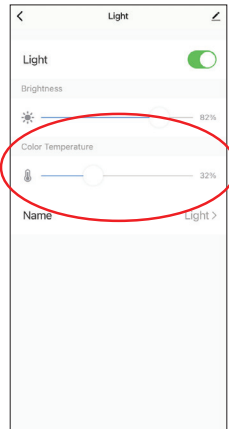

Set up Home in App to enable sharing

Follow steps below to allow multiple users to control fan with other mobile devices

East Grove

• HOME •

1

From the home page, select "me" in the bottom right corner

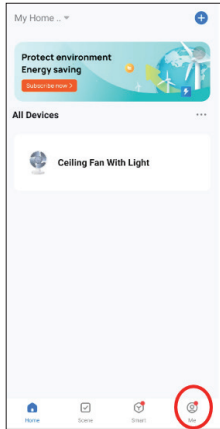

2

Then press "Home Management"

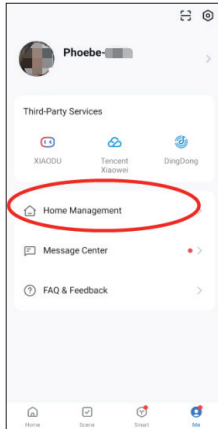

3

Then "Create a home"

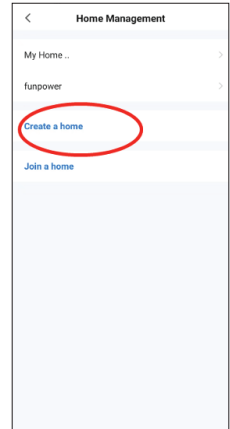

4

Enter a custom "Home name" here

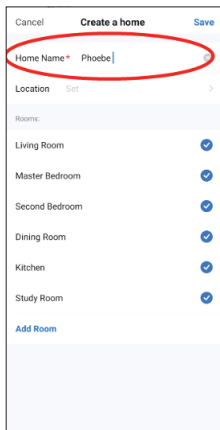

5

When "Home successfully created" appears, press "Done"

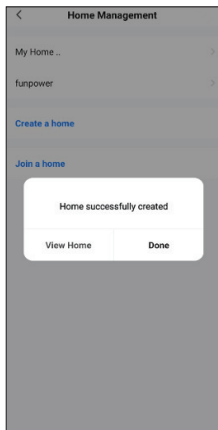

6

Now from the home screen, other users on the same WIFI can operate the fan from the app

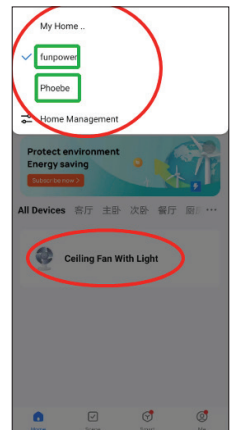

How to Unpair and Remove Your Ceiling Fan from the Smart Life App

1 From home screen, select ceiling fan to remove

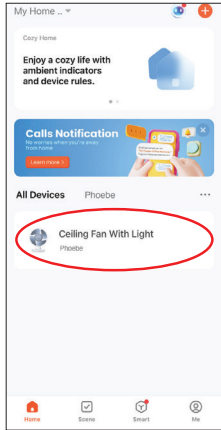

2 Select "Remove Device" at the bottom of the screen

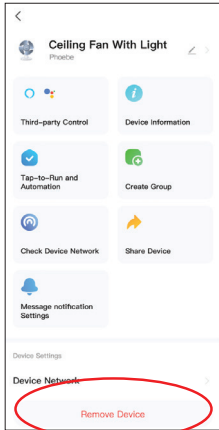

3 Choose "Remove" or "Remove and Clear Data"

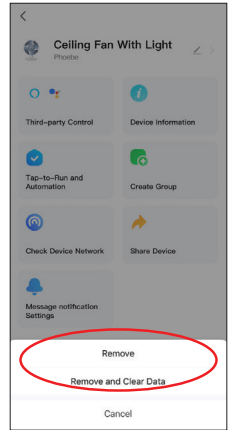

4 Select "Confirm" to complete un-pairing device process

