



Electric Fireplace Inserts User Manual

Size : 25.35"W , 30.5"W , 33"W , 36"W , 36"W21"H , 40"W , 43"W , 50"W

**NO VENTING REQUIRED
AC120V 60 Hz 750/1500 Watts**



⚠ WARNING

Read and understand this entire owner's manual, including all safety information, before plugging in or using this product. Failure to do so could result in fire, electric shock, or serious personal injury.

⚠ CAUTION

Keep this owner's manual for reference. If you sell or give this product away, make sure this manual accompanies this product.

Do Not Return This Item

If you have any questions about assembly or operation or missing parts, or product is damaged of this product, please contact us feel free.

**E-mail: flameline@flamelinefireplaces.com
Tel.: 302-281-1886**



Table of Contents

Important Instructions.....	1
Unpacking And Testing Appliance.....	3
Grounding Appliance.....	3
Packing List.....	3
Specification.....	3
Product Dimension.....	4
Installation.....	5
Operation.....	6
Temperature Limiting Control.....	6
Heater Rating.....	6
Remote Control /Switch Panel Instruction.....	6
Remote Control Battery Information.....	8
Safety Instructions.....	9
Care and Maintenance.....	10
Cleaning instruction.....	10
Maintenance.....	10
Trouble shooting.....	11
Limited Warranty.....	12

! **IMPORTANT:** It is important to read these instructions carefully before using the appliance for the first time. Keep the instructions safe so that you can refer to them later if necessary.

Important Instructions

When using electrical appliances basic precautions should always be followed to reduce the risk of fire, electric shock, and injury to persons, including the following:

- **Read all instructions before using this heater.**
- This heater is **hot when in use**. To avoid burning, **DO NOT** touch its hot surface. If required, use handles when moving this heater. Keep combustible materials, such as furniture, pillows, bedding, papers, clothes, and curtains at least 3 feet(0.9m) from the front of the heater and keep them away from the sides and rear. In order to avoid overheating, **DO NOT** partially or fully cover the vent in front of the heater.
- **Extreme caution** is necessary when any heater is used near children or the infirm and whenever the heater is left operating and unattended.
- **Always** unplug the heater when not in use.
- **DO NOT** operate any heater with a **damaged cord or plug** or after the **heater malfunctions**, has been **dropped**, or is **damaged in any manner**, return the heater to an authorized service facility for examination, electrical or mechanical adjustment, or repair.
- **INDOOR use only! Never use this heater outdoors!**
- This heater is not intended for use in bathrooms, laundry areas, and similar indoor locations. **NEVER** locate the heater where it may fall into a bathtub or other water container.
- **DO NOT** run cord under carpeting. Do not cover the cord with throw rugs, runners, or similar coverings. Arrange the cord away from the traffic area so that it will not be tipped over.
- To disconnect the heater, turn the controls off, then remove the plug from the outlet.
- **ALWAYS** plug heaters directly into a wall outlet/receptacle. **NEVER** use an extension cord or relocatable power tap (outlet/power strip). Connect to properly grounded outlets **ONLY**.
- **DO NOT** insert or allow **foreign objects** to **enter any ventilation or exhaust opening** as this may cause an **electric shock** or fire, or **damage the heater**.
- To prevent a possible fire, **DO NOT** block air intakes or exhaust. **DO NOT** use soft surfaces, like a bed, where openings may become blocked. **DO NOT** rinse or get wet
- A heater has **hot and arcing or sparking parts inside**. **DO NOT** use it in areas where gasoline or flammable liquids are used or stored.
- **Use this heater only as described in this manual. Any other use not recommended by the manufacturer may cause fire, electric shock, or injury to persons.**
- Replacement of the lamps should be done only while the heater is **disconnected** from the supply circuit.
- This appliance is not intended for use by persons (including children) with reduced physical,

sensory or capabilities, or lack of experience and knowledge unless they have been given supervision or instruction concerning the use of the appliance by a person responsible for their safety.

- Children should be supervised to ensure that they do not play with the appliance.
- **CAUTION:** In order to avoid a hazard due to inadvertent resetting of the thermal cut-out, this appliance must not be supplied through an external switching device, such as a timer, or connected to a circuit that is regularly switched on and off by the utility.
- **NEVER** permanently install in a recessed area of the wall. This may result in blocked air flow, overheating, or fire.
- **WARNING: DO NOT DEPEND ON THE POWER SWITCH THE SOLE MEANS OF DISCONNECTING POWER WHEN SERVICING OR MOVING THE HEATER. ALWAYS UNPLUG THE POWER CORD.**
- **WARNING: REDUCE THE RISK OF FIRE OR ELECTRIC SHOCK---DO NOT USE THIS HEATER WITH ANY SOLID STATE SPEED CONTROL DEVICES.**
- **This product is not intended to be a primary heat source. It is for supplemental heat ONLY.**
- **NEVER** modify this heater. Doing so could result in personal injury or property damage.
- Modification of this fireplace completely voids all warranties.
- **ONLY** use this heater on a 120V AC 15-Amp circuit. **NEVER** overload the circuit. If this heater trips the circuit breaker, unplug all other appliances on the same circuit before the next use.
- Avoid plugging other appliances into the same circuit as this heater.
- **ALWAYS** check your heater cord and plug connections with each use!
- **MAKE SURE** the plug fits tightly in the outlet! Faulty wall outlet connections or loose plugs can cause the outlet to overheat.
- **Heaters draw more current** than small appliances. Overheating may occur even if it has not occurred with the use of other appliances.
- During use check frequently to see if the plug outlet or faceplate is **HOT!**
- If the outlet or faceplate is **HOT, discontinue use** immediately and have a qualified electrician inspect and/or replace the faulty outlets.
- This heater has a polarized plug (one blade is wider than the other). As a safety feature to reduce the risk of electrical shock, this plug is intended to fit in a polarized outlet only one way. If the plug does not fit fully in the outlet, reverse the plug. If it still does not fit, contact a qualified electrician. Do not attempt to defeat this safety feature.
- **SAVE THESE INSTRUCTIONS!**

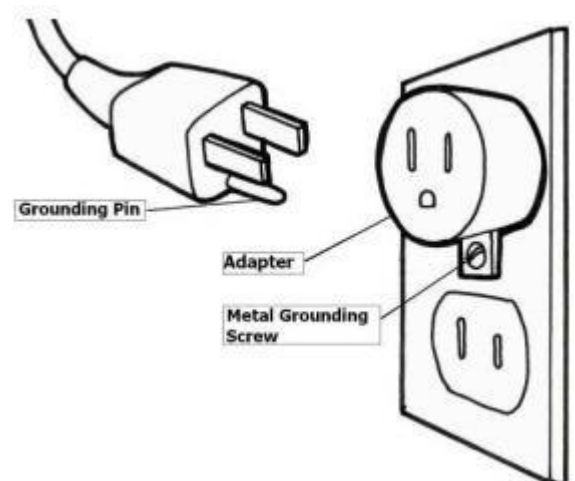



DO NOT use this Electric Fireplace if any part has been under water. Immediately call a qualified **service technician** to inspect and to replace any part of the electrical system if necessary. Keep plastic wrapping away from **children**.

Unpacking And Testing Appliance

Remove all parts and hardware from the carton and place them on a clean, soft, dry surface. Check the parts list to make sure no parts are missing. If parts are missing, please contact technical support for replacement.



Prior to installing the appliance, test to make sure the appliance operates properly by plugging the power supply cord into a conveniently located 110-120 Volt grounded outlet.

NOTE: Dispose of plastic bag, as it may cause choking hazard with young children. Do not let children play with plastic bag.

● Grounding Appliance

This appliance is for use on 120 Volts. For connecting three-blade grounding type plugs to three -slot receptacles. The green grounding lug extending from the adapter must be connected to a permanent ground such as a properly grounded outlet box. The adapter should not be used if a three-slot grounded receptacle is available. To disconnect appliance, turn controls off, then remove the plug from outlet.

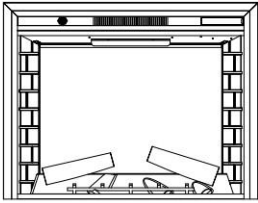
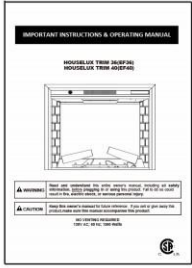
Packing List

 <p>Firebox X 1 pc</p>	 <p>Owner's Manual X 1 pc</p>
 <p>Remote Handset X 1 pc</p>	

Specification

Model	Houselux Trim (EFT)
Power supply	120V-60Hz
Amps	15
Power consumption	Max1500W
Light bulb	LED
Cord length	6 ft

Product Dimensions

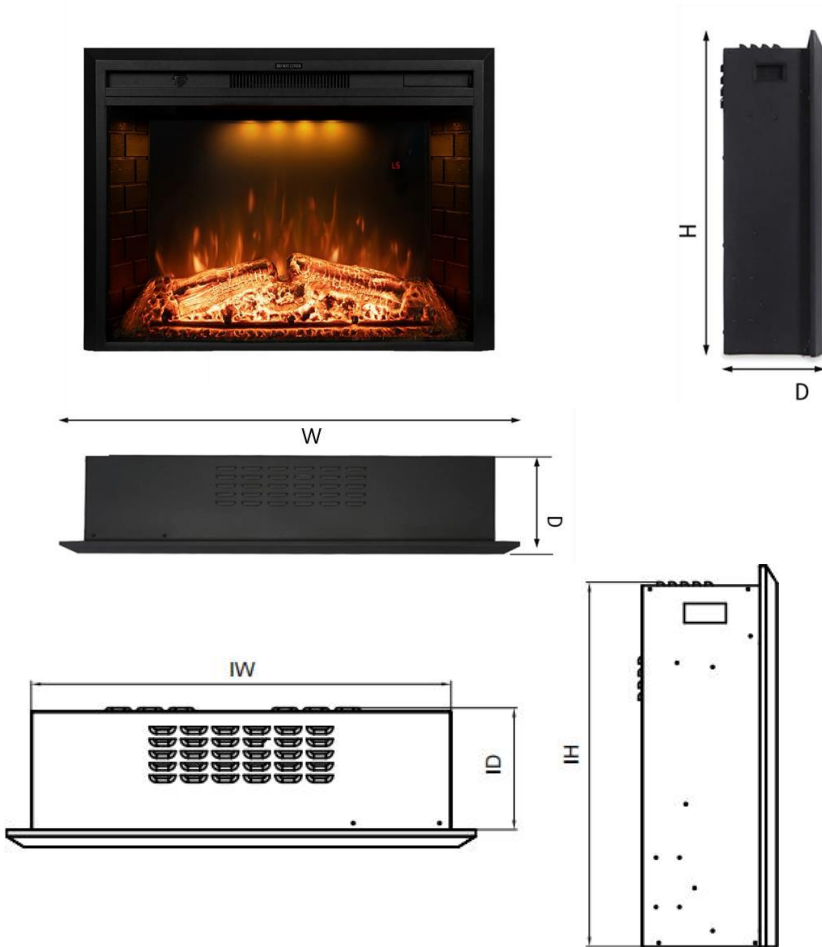

Dimensions FOR Insert Part

Unit: inch

MODEL	Size (Outer Width)	Insert Width (IW)	Insert Height (IH)	Insert Depth (ID)
EF23T	25.35"W	21.95	19.61	7.7
EF28T	30.50"W	27.11	23.43	7.7
EF30T	33"W	29.59	23.43	7.7
EF33T	36"W	32.23	26.02	7.7
EF33WT	36"W21"H	32.23	19.61	7.7
EF36T	40"W	36.62	26.18	7.7
EF40T	43"W	39.57	26.18	7.7
EF50T	50"W	46.62	26.18	7.7

Dimensions FOR Overall Sizes and Advise Installation Sizes

Unit: inch

MODEL	Size (Outer-Width)	Width (W)	Height (H)	Depth (D)	Advise Installation Opening Size		Advise Installation Minimum Depth
					Width (OW)	High (OH)	Depth (RD)
EF23T	25.35"W	25.4	20.9	8.84	22.3-22.4	19.9-20.0	8.5-8.7
EF28T	30.50"W	30.5	24.7	8.84	27.5-27.6	23.7-23.8	8.5-8.7
EF30T	33"W	33.0	24.7	8.84	30.0-30.2	23.7-23.8	8.5-8.7
EF33T	36"W	35.6	27.32	8.84	32.6-32.7	26.4-26.5	8.5-8.7
EF33WT	36"W21"H	35.6	20.9	8.84	32.6-32.7	20.0-20.2	8.5-8.7
EF36T	40"W	40	27.32	8.86	37.0-37.2	26.6-26.8	8.86-9.06
EF40T	43"W	43	27.32	8.86	39.9-40.2	26.6-26.8	8.86-9.06
EF50T	50"W	50	27.32	8.86	47.0-47.2	26.6-26.8	8.86-9.06

Installation

Your new electric fireplace may be installed virtually anywhere in your home. However, when choosing a location ensure that the general instructions are followed. For best results, install out of direct sunlight. Power supply service must be either completed or placed within the electric fireplace prior to finishing to avoid reconstruction.

WARNING:

- AFTER installation, ensure that there is $\geq 0.004 \text{ m}^2$ ventilation area between inside and outside of fireplace
- When moving the insert into the mantel, DO NOT let bottom of insert touch the mantel to avoid the scratch.

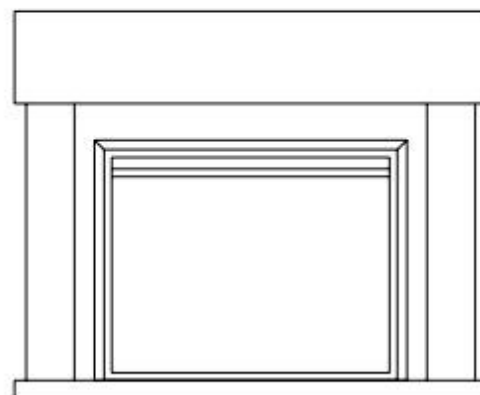
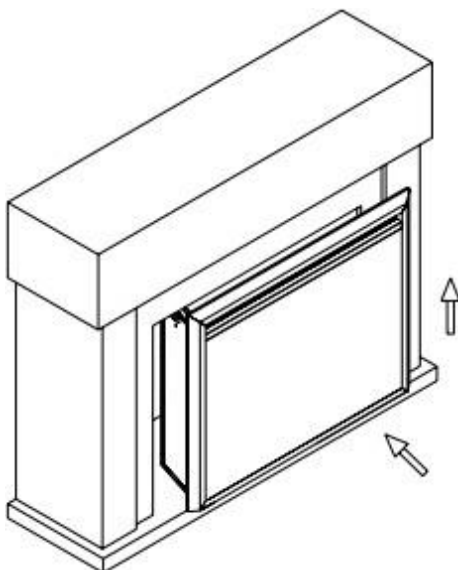

Operation

Plug the power cord into a 110-120 Volt 15 Amp outlet. Make sure the outlet is in good condition and that the plug is not loose. **NEVER** exceed the maximum amperage for the circuit. **DO NOT** plug other appliances into the same circuit.

● Temperature Limiting Control

This heater is equipped with a Temperature Limiting Control. Should the heater reach an unsafe temperature (212°F / 100°C), the heater will automatically turn OFF.

To reset:

1. Unplug the power cord from the outlet
2. Turn the ON/OFF switch on the CONTROL PANEL to OFF. **Wait at least 5 minutes.**
3. Inspect the fireplace to make sure no vents are blocked, or clogged with dust or lint. If they are, use a vacuum to clean the vent areas.
4. With the POWER switch in the OFF position, plug the power cord back into the outlet.
5. If it switches off again, **UNPLUG THE HEATER RIGHT AWAY!** Have the outlets, wiring, and breaker box inspected by a professional. Make necessary repairs before using the heater

● Heater Rating

Maximum Heat Output: 1500 W (5000 BTU)

Maximum Heating Area: 400 square feet.



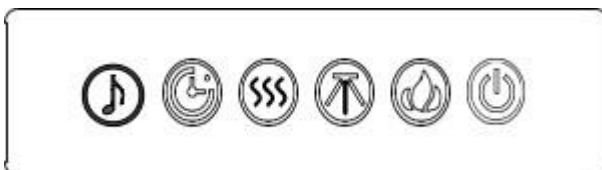
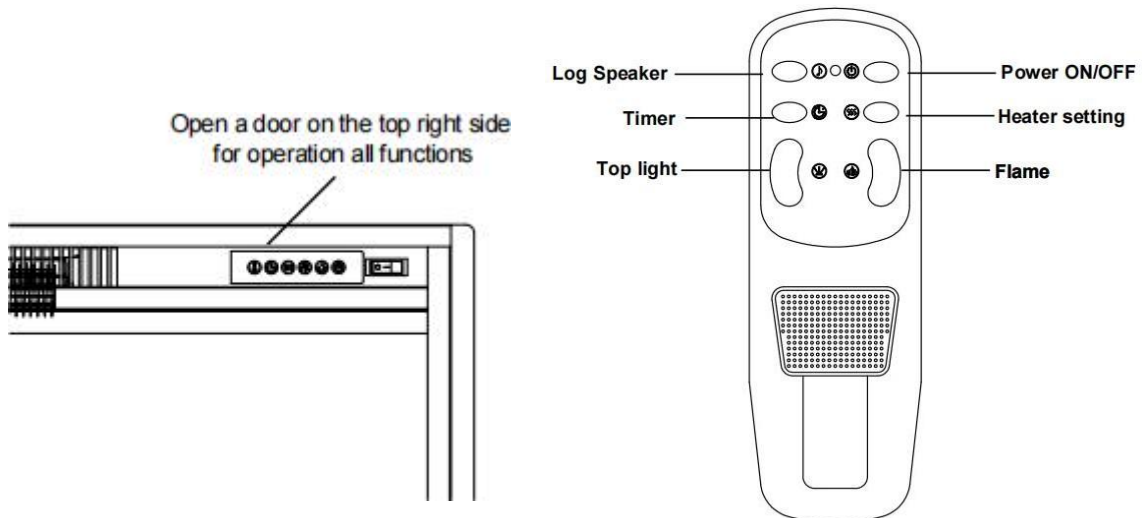



● Remote Control /Switch Panel Instruction



(Control panel power switch must be ON to use remote control.)

The touch display panel is shown by LED's on the front bottom right of the appliance. The LED's will appear on the bottom of the fireplace control panel.

WARNING: Do not move or remove the mesh trim panel, when the appliance is plugged in and operating. This will cause the remote control and touch panel to no longer function.

POWER		Turns the appliance ON/OFF.
FLAME		Controls Flame change. The flame will be cycled F1 – F2 – F3 – F4 – F5- Flame Off. F1 is the less flame,F5 is the biggest flame.
TOP LIGHT		Controls Log Flame change. There are three colors for option. Press the first time for orange color, Press the second time for the blue color, Press the third time for the purple color.
HEATER		Controls the Heater. Press button to initiate the heater. (OFF) no heater or blower. (LO), heater blows warm air (750W) (HI), heater blows hot air (1500W) NOTE: Heater functions cycle from OFF-LO-HI
TIMER		Controls the Timer. <u>9 Settings:</u> (1h, 2h, 3h, 4h, 5h, 6h, 7h, 8h,9h) Press button until reach desired setting.
LOG SPEAKER		The log speaker can make the real log burning effect. Press first time to turn on the log speaker, Press second time to turn off the log speaker.

● Remote Control Battery Information

- This remote control uses two AAA batteries (Not included).
- Instructions for battery installation are on the Remote Control battery compartment.

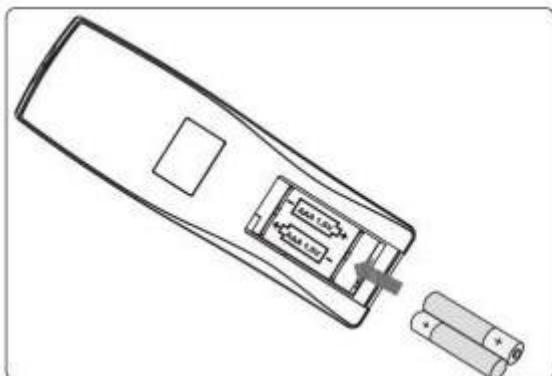

NEVER dispose of batteries in **fire**. Failure to observe this precaution **may result in an explosion**. Dispose of batteries at your local hazardous material processing center.

NOTICE

When the heater is first turned on, a slight odor may be present. This is normal and should not occur again unless the heater is not used for a long period of time.

NOTICE

To improve operation, **aim** the remote control at the front of the fireplace. **DO NOT press the buttons too quickly**. Give the unit time to respond to each command.

Safety Instructions

- Only use the appliance in accordance with the instructions in this manual! It cannot be used for any other purpose.
- Never operate the appliance when the appliance itself or the main cable show any signs of damage. In order to avoid overheating, do not cover the heater.
- Be responsible when handling the packing material. Warning: plastic wrapping may be lethal to children. Do not place the appliance next to a socket.
- Never operate the heater on a program switch, timer switch or any other appliance for automatic operation.
- The heater is only suitable for indoor use.
- Never use the heater in the bathroom, shower or near a swimming pool. The heater must not be located immediately below a socket-outlet
- If the supply cord is damaged, it must be replaced by the manufacturer or its service agent or a similarly qualified person in order to avoid a hazard.
- Never leave small children unattended near the appliance. In case of malfunction, disconnect the plug immediately.
- When not in use for a considerable amount of time, unplug the appliance. Components should only be serviced by an approved electric technician.

To switch on:

Plug in the appliance into the socket. Turn on the **Power Switch**.

The control **Switch Panel** is on the bottom of fireplace (**See pic**).

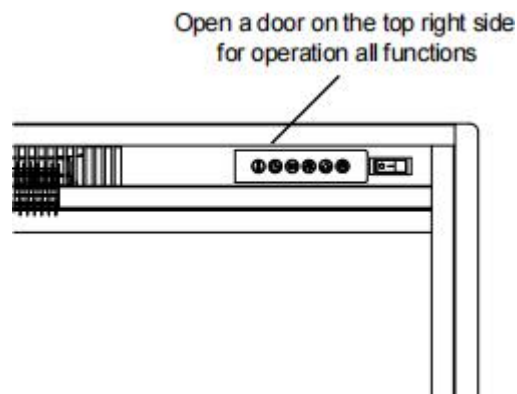

Care and Maintenance

● Cleaning instruction



ALWAYS turn the heater **OFF** and **unplug the power cord from the outlet** before cleaning, performing maintenance, or moving this fireplace. Failure to do so could result in **electric shock, fire, or personal injury**.



NEVER immerse in water or **spray with water**. Doing so could result in **electric shock, fire, or personal injury**.

Glass:

- ① Use a good quality glass cleaner sprayed onto the cloth or towel. Dry thoroughly with a paper towel or lint-free cloth.
- ② NEVER use abrasive cleansers, liquid sprays, or any cleaner that could scratch the surface.

Vents:

Use a vacuum or duster to remove dust and dirt from the heater and vent areas.

Plastic:

- ① Wipe gently with a slightly damp cloth and a mild solution of dish soap and warm water.
- ② NEVER use abrasive cleansers, liquid sprays, or any cleaner that could scratch the surface

Metal:

- ① Buff using a soft cloth, slightly dampened with a citrus oil-based product.
- ② DO NOT use brass polish or household cleaners as these products will damage the metal trim.

● Maintenance

- ◆ After installation, the power plug should be accessible.
- ◆ If the power cord is damaged. It must be replaced by the manufacturer or its service agent or a similarly qualified person in order to avoid a hazard.
- ◆ The heater must not be located immediately below a socket.
 - ◆ The appliance is not intended for use by young children or infirm persons. Young children should be supervised to ensure that they do not play with the appliance.
- ◆ Do not use this heater in the immediate surroundings of a bath, a shower or a swimming pool.
- ◆ In order to avoid overheating, do not cover the heater.
- ◆ Electrical and Moving Parts: The fan motors are lubricated at the factory and will not require lubrication. Electrical components are integrated in the fireplace and are not serviceable by the customer.
- ◆ Storage: Store fireplace in a clean, dry place when not in use.

Trouble shooting

1.Q: Unit does not heat?

- A:** 1. Turn on the heater to see if the heater will work continuously.
2. If not, unplug the unit for a whole night. And then turn it on again.
3. If still not, contact service team for help

2.Q: Why is there no flame effect?

- A:** 1. Make sure the unit is plugged into a power outlet.
2. Check if the main power on the right side of the fire place is turned on.
3. Switch the flame color by the remote or touch screen to check whether there is flame effect.
4. If still not, please contact service team for help.

3.Q: Fireplace turns off and will not turn on.

- A:** Fireplace has overheated and safety device has caused thermal switch to disconnect or home circuit breaker has opened. Reset switch by turning main power off and waiting turning it back on or breaker circuit breaker.

4.Q: The remote does not work and the new unit cannot be turned on.

- A:** 1. Replace batteries in remote control.
2. Aim control at sensor located directly behind glass screen in center of unit just above logs.
3. Replace remote control and/or sensor.

5.Q: The front trim is out of shape, the remote is missed or the log is broken.

- A:** Please contact customer service for a replacement and instruction.

6. Q: There is a black tie inside the unit or there is a small spot on the glass.

- A:** Please contact customer service for an instruction of removing the glass.

7.Q: There is a noise only when the flame is on.

- A:** The spindle touches the wires or panels around, please contact customer service team for a checking instruction manual.

8.Q: The heater of my new product does not work.

1. There is no air blowing.

Check if the connector on the PCB board that links to the fan is loosen, if not, the problem might be the PCB board.

2. There is only cold air.

The heating element might be broken. Please contact customer service team for help.

3. It blows a little heat and then shut off and never come back unless re-plug it.

The fan might be stuck or the heat motor is fall off. Confirm if there is something getting red inside the air outlet when turn the heater on, then contact customer service for help.

4. The blower works for about 5s then shuts off.

Press the temperature on the remote until there is no temp number showing on the remote display to see if the blower will work. If not, check if the sensor is loosen, if yes, please kindly noted that there would be a 3 degree deviation between the temp the sensor feels and the room temperature.

Limited Warranty

- This warrants to the original purchaser that this product is free from defects in material and workmanship as of the date of purchase and that it will, under normal use and proper care, remain so for one year from the date of purchase.
- Missing or initially defective parts will be replaced free of charge during the period of this limited warranty. If parts are unavailable, comparable replacement or refund will be given. The original dated sales receipt is required for all warranty claims.
- This warranty does not cover damage which has occurred during transport from the point of purchase to the consumer's home.
- This warranty does not cover glass, light bulbs, batteries, transportation, labor, or other issues not associated with the manufacture of the product.
- This product is for residential use only. Any and all commercial use of this product voids all warranties, and frees the manufacturer from all liability.
- Read and understand all assembly and operating instructions, and all safety information and warnings before use.
- The following will void this warranty: Damage caused from tampering with, modifying, or altering the fireplace insert in any manner; Damage due to incorrect assembly, improper care, misuse, or abuse; Damage from being used with the wrong power source; Water damage; Damage caused from this insert being used outdoors; Damage caused from this insert being used for excessive periods of time; Damage caused by the insert being used in a commercial application; Damage from use as a primary heat source; Other misuse or abuse not specifically listed herein.
- This product is not intended to be used as a primary heat source. It is for supplemental heating purposes only.

Thank you for purchasing this product!

For immediate help with assembly, or product information, or if your product arrives damaged, please contact us first. Our staff are ready to provide assistance.

E-mail: flameline@flamelinefireplaces.com

Tel.: 302-281-1886

