

# ASSEMBLY INSTRUCTION







## CHAIR

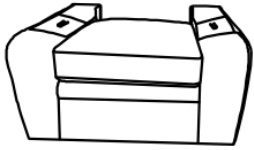

Legs and hardware are stored in the bubble bag and located underneath the seat, please take out for assembly

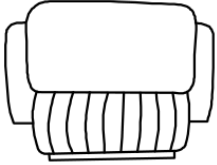
Note: Do not use power tools for assembly. Power tools increase the risk of over tightening which lead to splitting or cracking the wood

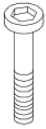
### Component list .

| Label | Picture   | Description | QTY(pc) |
|-------|---|-------------|---------|
| A     |    | SEAT        | 1       |
| B     |  | LSF ARM     | 1       |
| C     |  | RSF ARM     | 1       |
| D     |  | BACK REST   | 1       |
| E     |  | PLASTIC LEG | 4       |
| F     |  | BOLT        | 4       |
| G     |  | FLAT WASHER | 4       |
| H     |  | DRIVER      | 1       |

Step #1

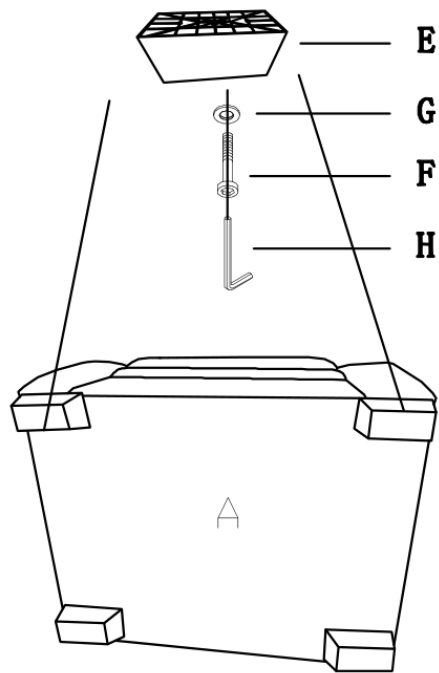

Step #2

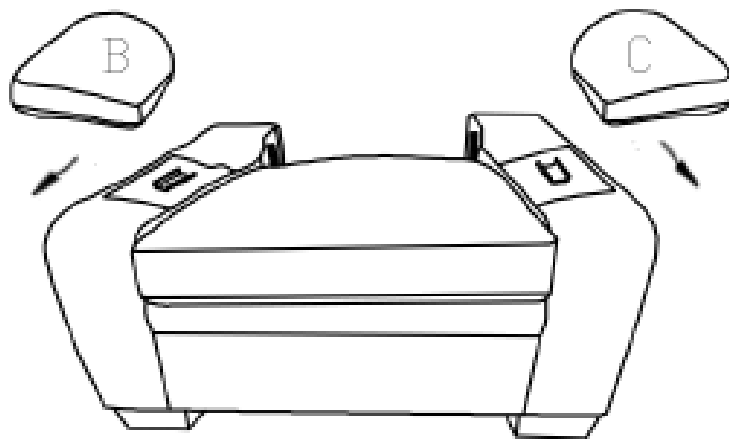

Step #3

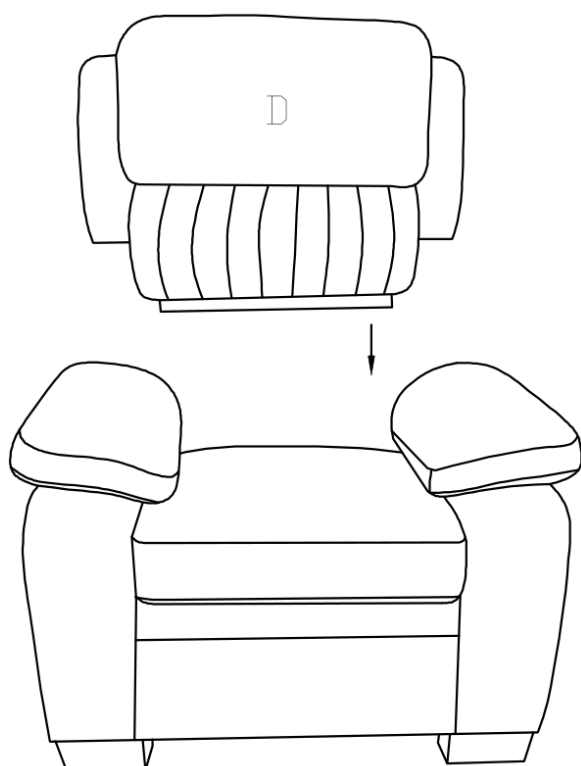

Step #4

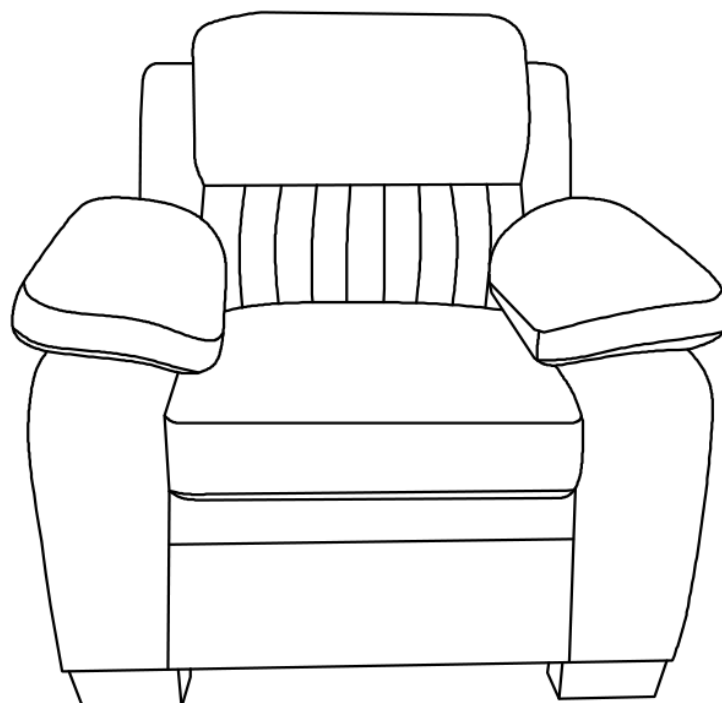

### Care Instruction for Textured Fabric Furniture:

In order to maintain the original appearance of your textured fabric furniture, please follow below simple care procedures:

- Avoid exposing furniture directly to sunlight or heating and air conditioning outlets. Sunlight and or exposure to heating and air conditioning outlets will fade/damage textured fabric .
- Vacuum or wipe with a soft cloth to remove dust.



For item use on wooden floor, hard surfaces or carpets, it is recommended to install protective pads under all legs and supports to avoid/prevent from damages/scratches and discoloration.