













ASSEMBLY INSTRUCTION

**(BOX 1)
BOX OF HEADBOARD & FOOTBOARD**

ITEM	DRAWING	DESCRIPTION	QTY
A		HEADBOARD PANEL	1
B		LEFT HEADBOARD LEG	1
C		RIGHT HEADBOARD LEG	1
D		FOOTBOARD PANEL	1
E		LEFT FOOTBOARD LEG	1
F		RIGHT FOOTBOARD LEG	1

**(BOX 1)
HARDWARE LIST**

ITEM	DRAWING	DESCRIPTION	QTY
1		JCBC SCREW (M6 x 45mm)	12
2		SPRING WASHER (M6) (1 / 4)	12
3		FLAT WASHER (M6 x 13mm)	4
4		WOOD PLUG	4
5		ALLEN KEY (M4)	1
6		FLAT WASHER (M6 x 19mm)	8

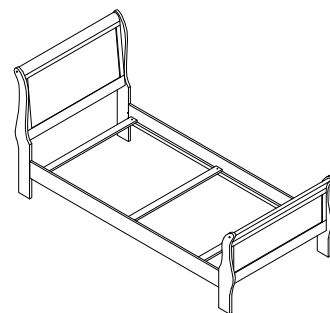

**COMPLETED TWIN BED
ASSEMBLY**

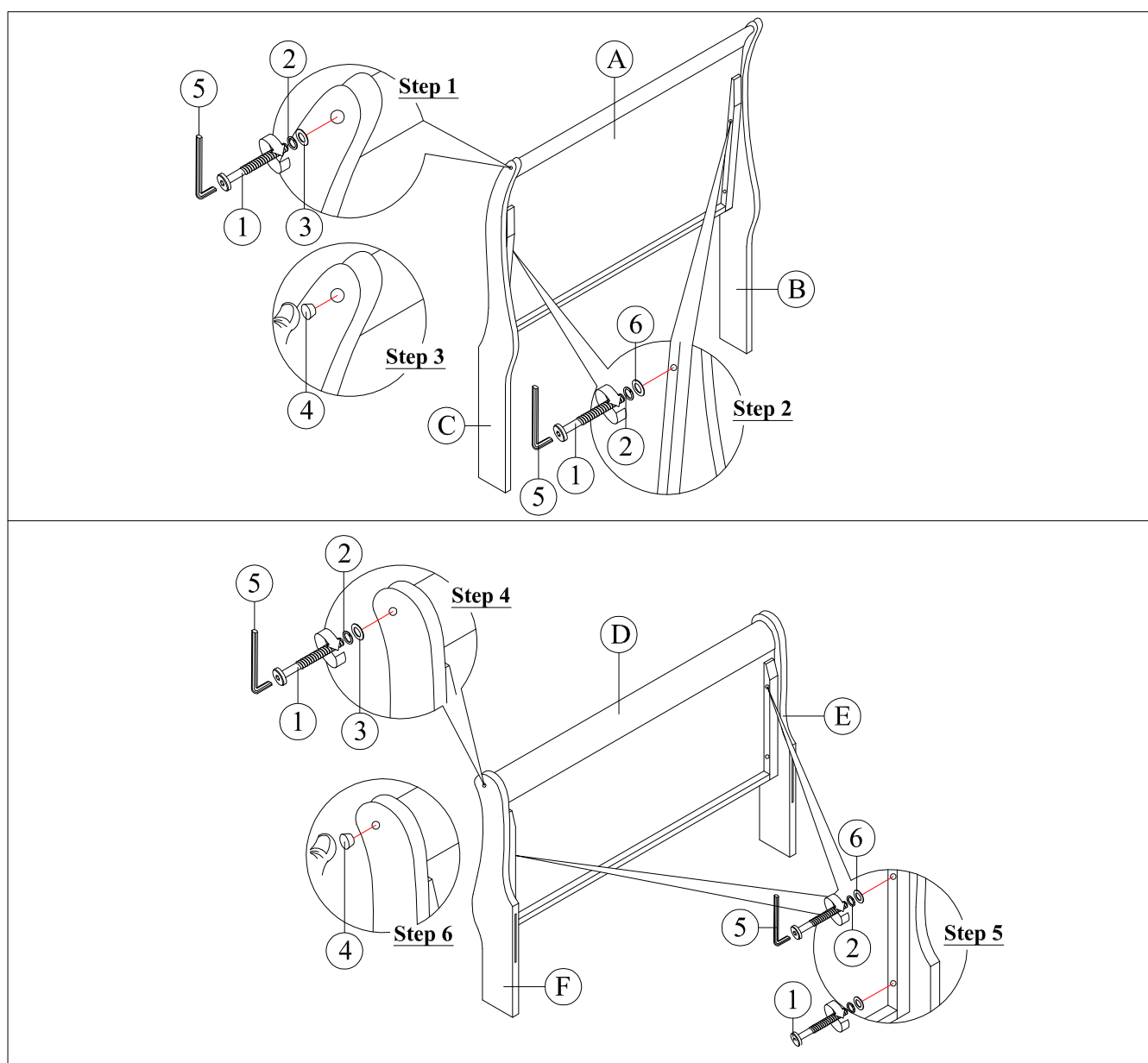

THE HARDWARE IS LOCATED IN THE PACKING ITEMS

NOTE : MUST TIGHTEN SCREWS PERIODICALLY. WITH USE SCREWS MAY BECOME LOOSE.
CHECK TIGHTNESS OF ALL SCREWS EVERY 6-8 WEEKS.

CLEANING INSTRUCTION

After assembled, clean & polish the completed parts if necessary with soft cloth and industrial recognized furniture polish

MADE IN MALAYSIA