

# Assembly Instruction

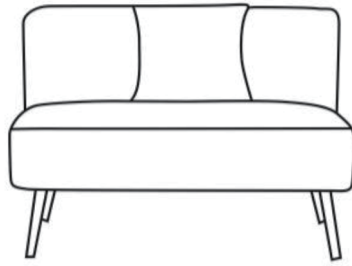

A

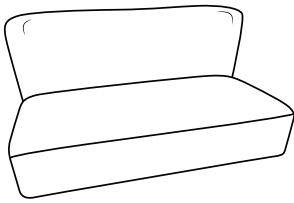

x1

B

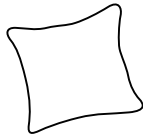

x1

C

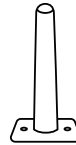

x4

D



x8

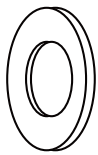

x8

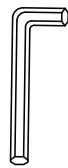

x1

STEP 1

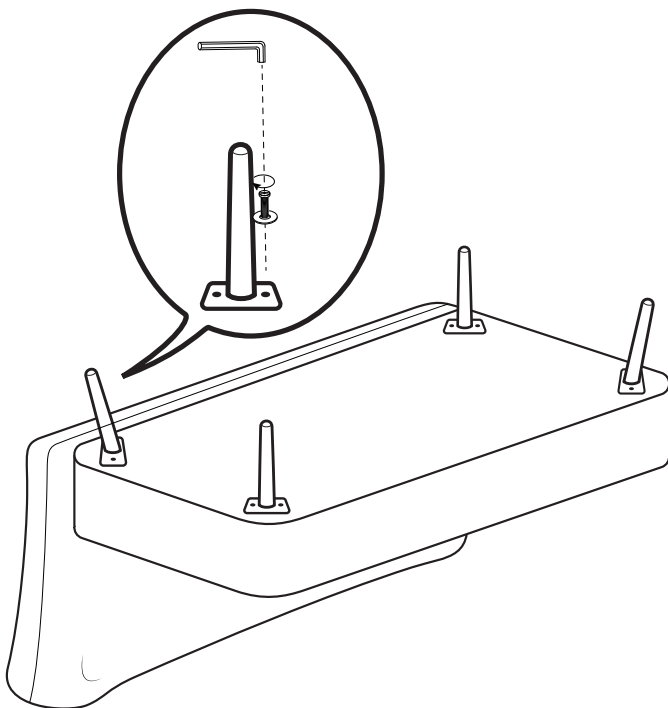

STEP 2

