

ASSEMBLY INSTRUCTION

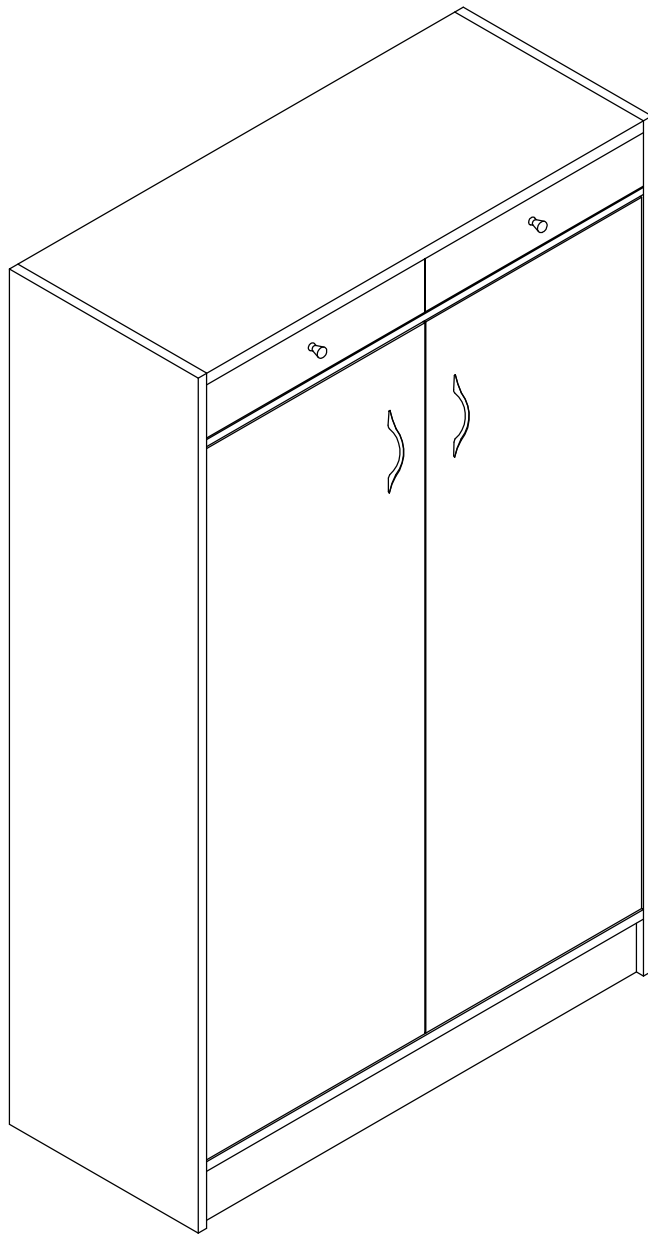

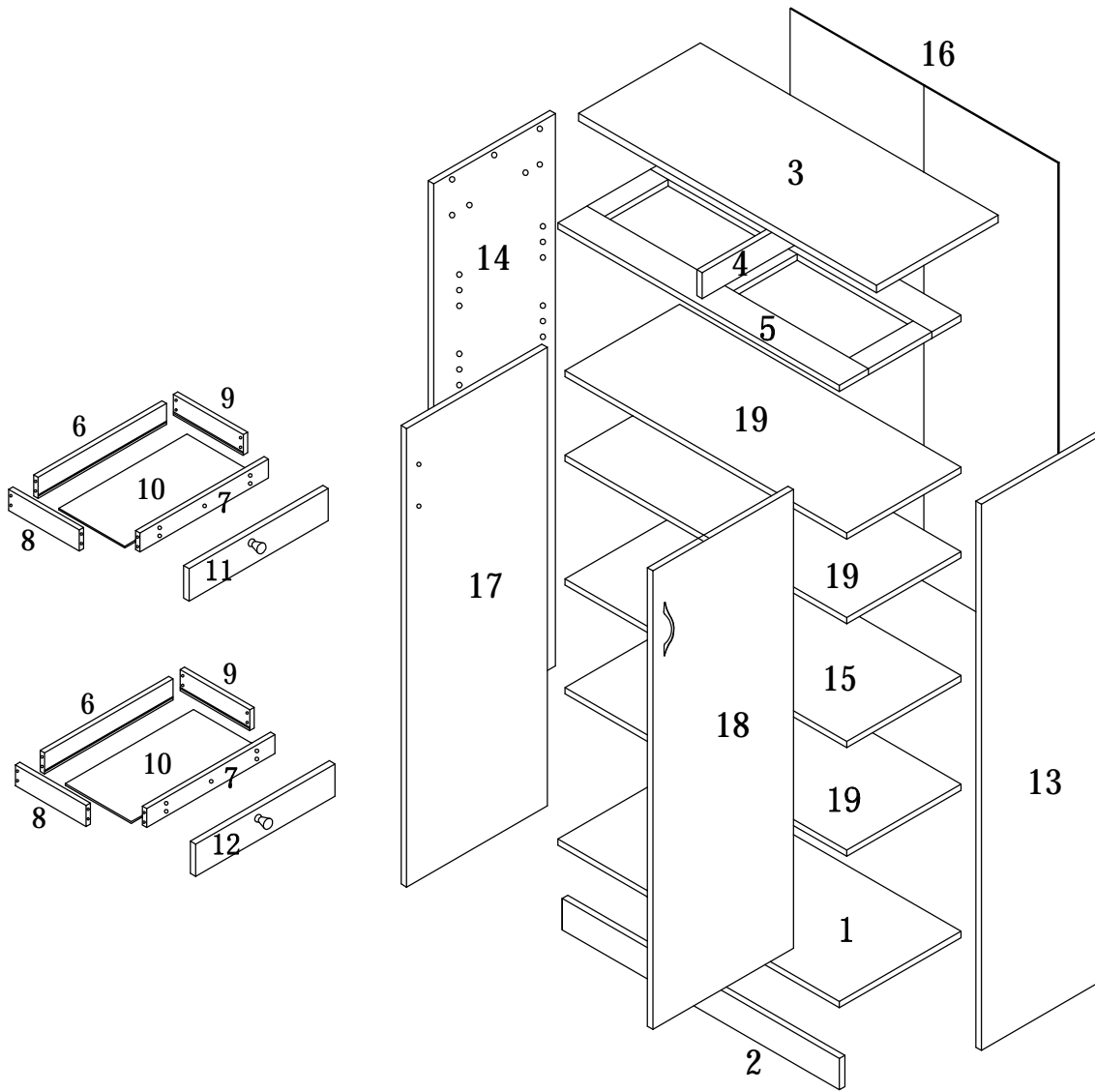









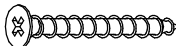
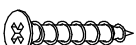



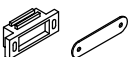







PARTS IDENTIFICATION

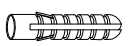

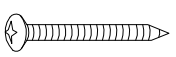
(1)	1pc	(8)	2pcs	(15)	1pc
(2)	1pc	(9)	2pcs	(16)	1pc
(3)	1pc	(10)	2pcs	(17)	1pc
(4)	1pc	(11)	1pc	(18)	1pc
(5)	1pc	(12)	1pc	(19)	3pcs
(6)	2pcs	(13)	1pc		
(7)	2pcs	(14)	1pc		

HARDWARE IDENTIFICATION

A		L29	4pcs
B		□15	4pcs
C		□4 x 40	20pcs
D		□4 x 30	16pcs
E		□4 x 25	10pcs
F		□4 x 32	2pcs
G		□5	2pcs
H			2pcs
I		□3 x 16	4pcs
J			30pcs
K		□8 x 25	13pcs
L			2pcs
M		□3 x 14	4pcs
N		96MM	2pcs
O		□4 x 20	4pcs
P		□5	12pcs
Q		□8 x 40	2pcs
R			1pc
S		□8 x 40	1pc
W		□8 x 40	2pcs
X		□5 x 40	1pc
T		□4 x 25	1pc
U		□16	5pcs
V			1pc

Glue: For securing please apply to wood dowel first before inserting into panel

ASSEMBLY INSTRUCTION

STEP1

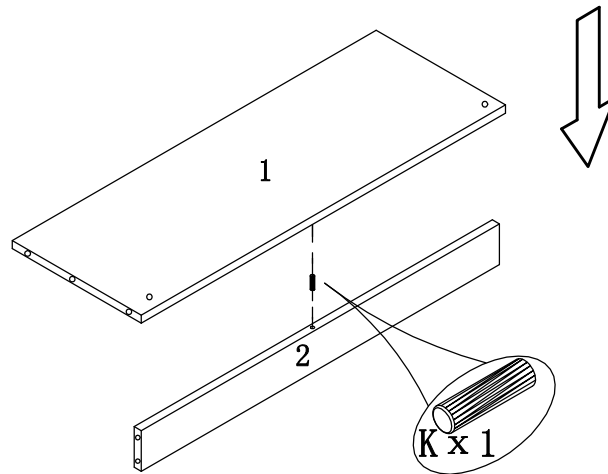

STEP2

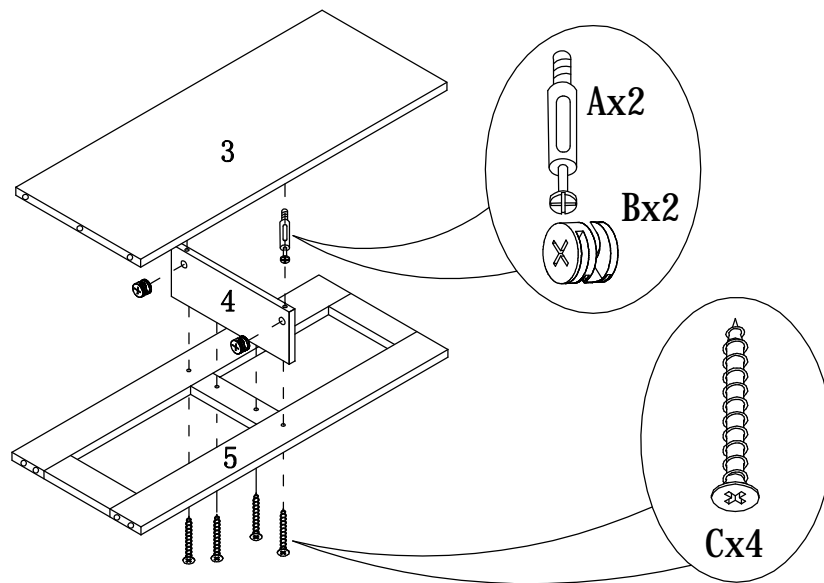

STEP3

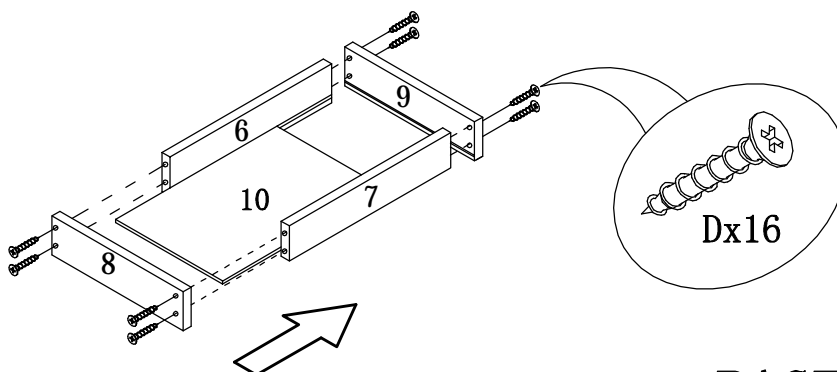

ASSEMBLY INSTRUCTION

STEP4

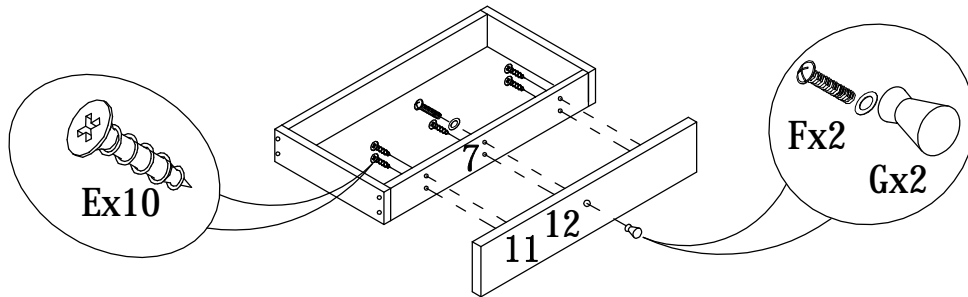

STEP5

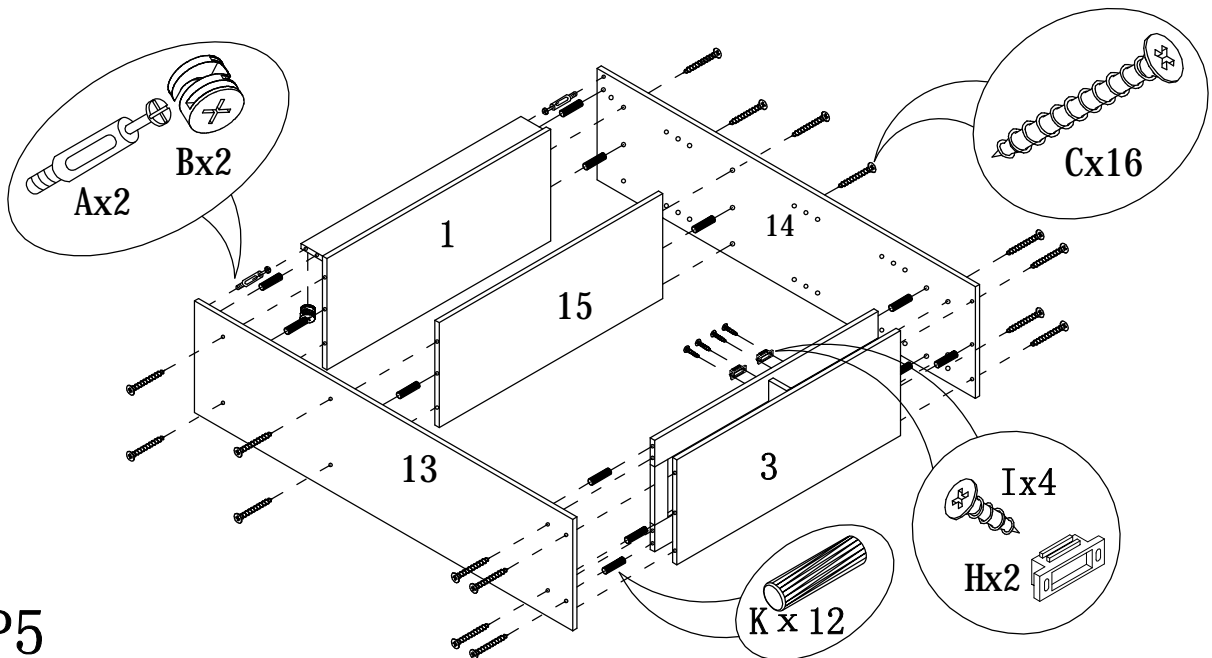

STEP6

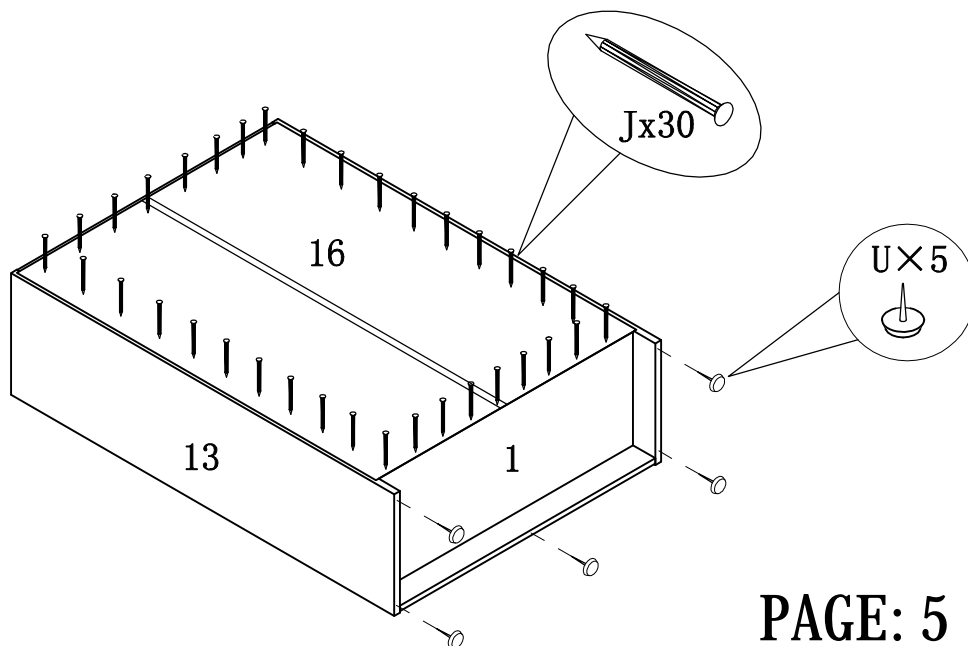

ASSEMBLY INSTRUCTION

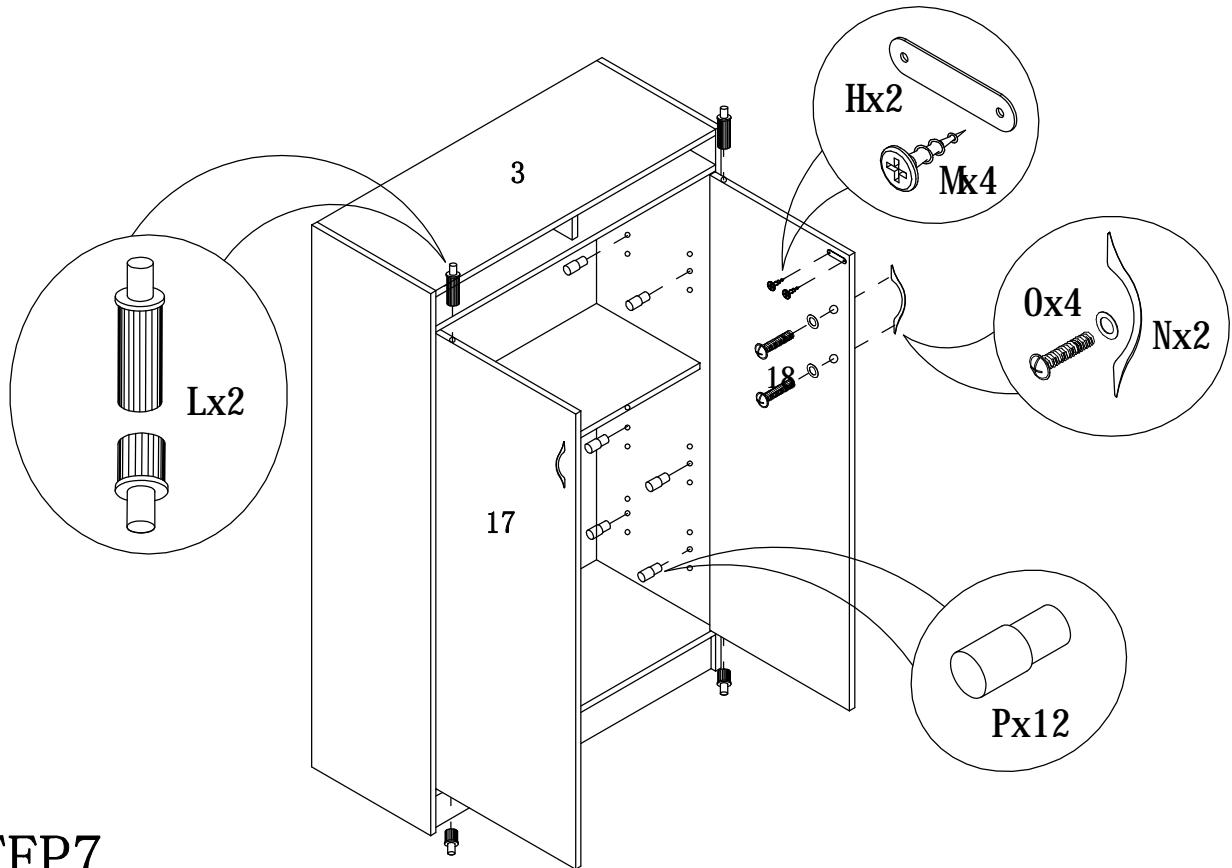

STEP7

STEP8

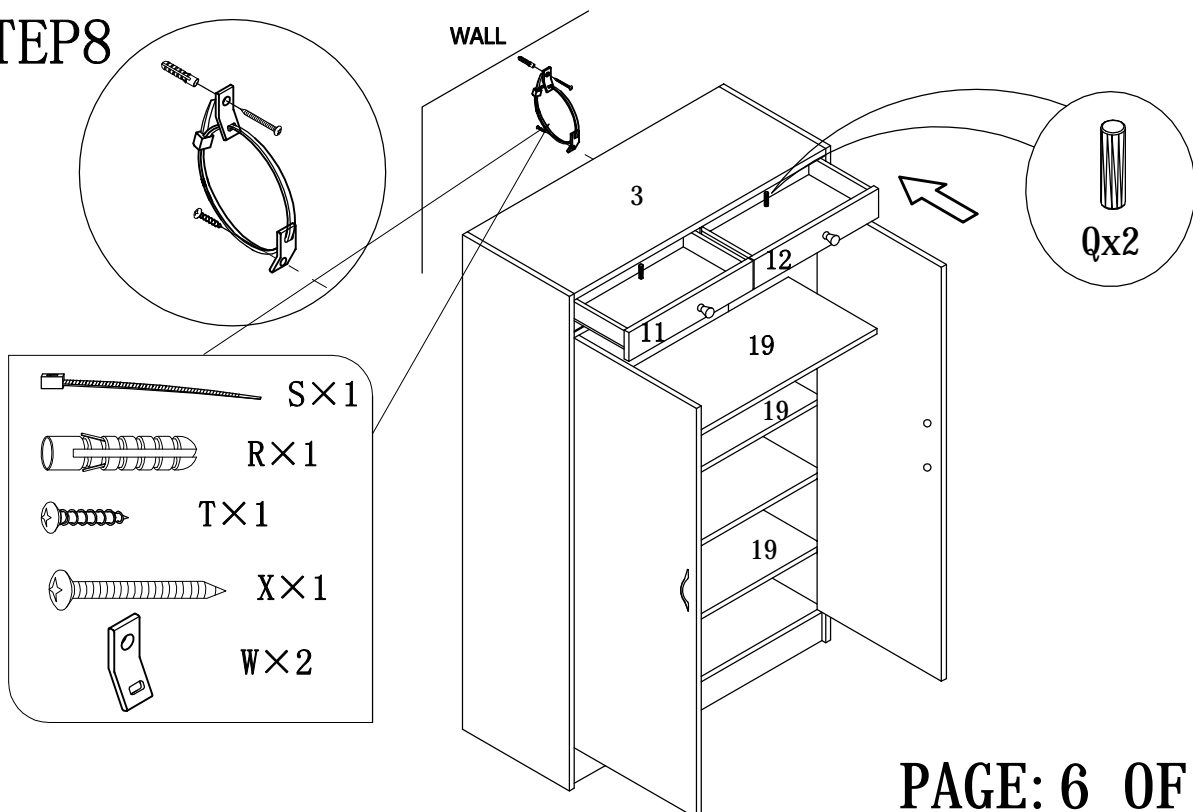

ASSEMBLY INSTRUCTION

PLEASE READ BEFORE ASSEMBLING!

Tip #1: Make sure you've taken all the pieces and hardware out of its packaging before discarding the box.

Tip #2: Using page 2 and/or page 3 of instruction manual make sure all pieces and hardware are accounted for.

Tip #3: Read manual before assembling, it helps!

