









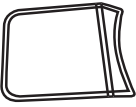

# Assembly Instruction

## Parts List:

NO.	part	Diagram	Qty pcs
A1	Left Arm		1
A2	Right Arm		1
B	Chair Back		1
C	Seat Panel		1
D	Runner		2
E	Bolts M6*38mm		10
F	Washers		10
G	Screws		4
H	Seat Cushion		1
I	Back Cushion		1
J	Wrench		1

\* Don't fully tighten all the bolts till the very end!

### PRE-ASSEMBLY PREPARATION:

--- Please read through the instructions before beginning assembly.

--- Clear out the space for assembly and lay out all of the parts based on the Parts List, extra room will allow you to easily determine if all the pieces are present.

--- Keep small parts and pieces away from children until fully assembled.

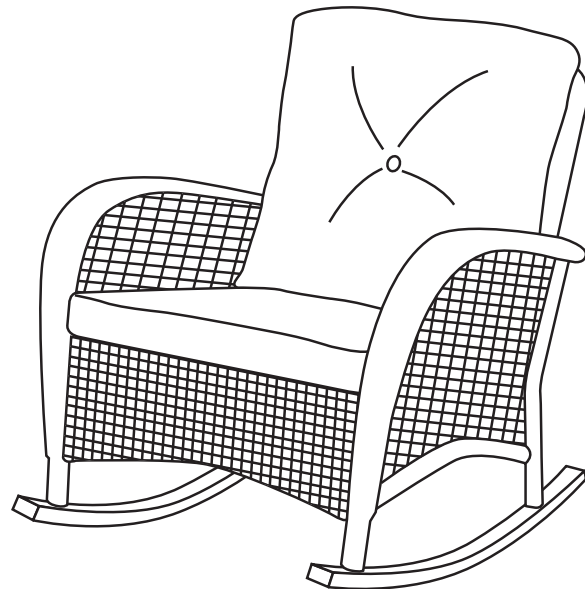

# Assembly Instruction

Step 1

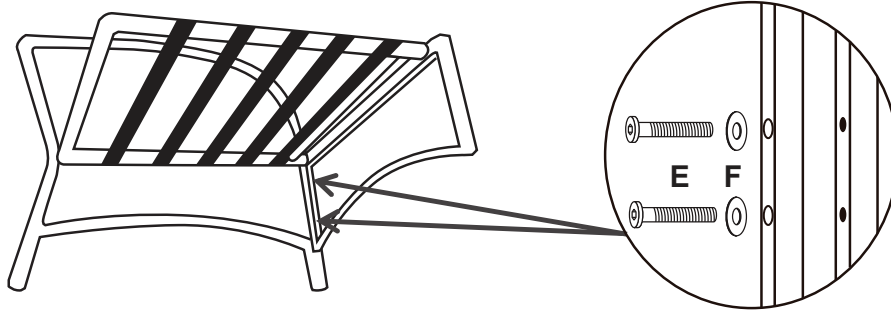

Attach left, right arms and seat panel with E and F. Don't tighten bolts!

Step 2

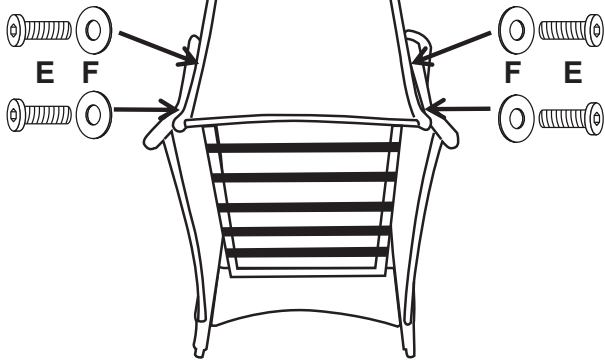

Don't tighten bolts!

Step 3

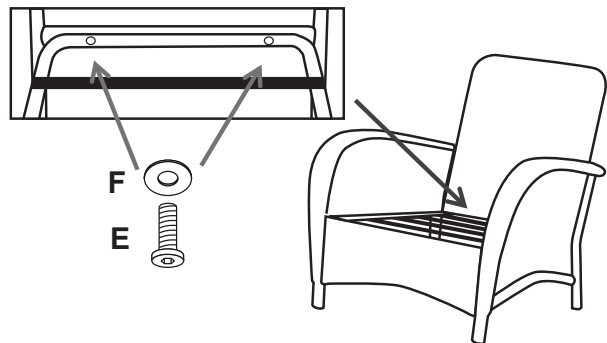

Tighten the bolts E 100%

Step 4

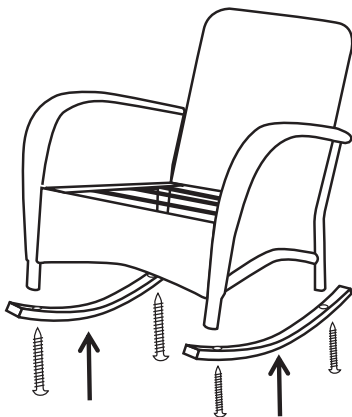

Tighten all the screws (G) with wrench (J).

Step 5

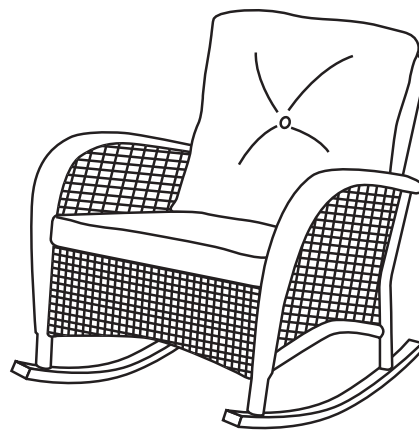





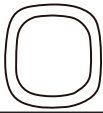

Now tighten all the bolts E.  
Put seat and back cushions on the chair.

The chair is full assembled now.

# Assembly Instructions

## Parts List (END TABLE):

NO.	part	Diagram	Qty pcs
A	Table Top		1
B	Table Leg		4
C	Table Shelf		1
D	Screws		12
E	Washers		12
F	Hex Wrench		1

