

# INSTALLATION MANUAL

## CHANDELIER

Model No.: OLDP002BW-3A

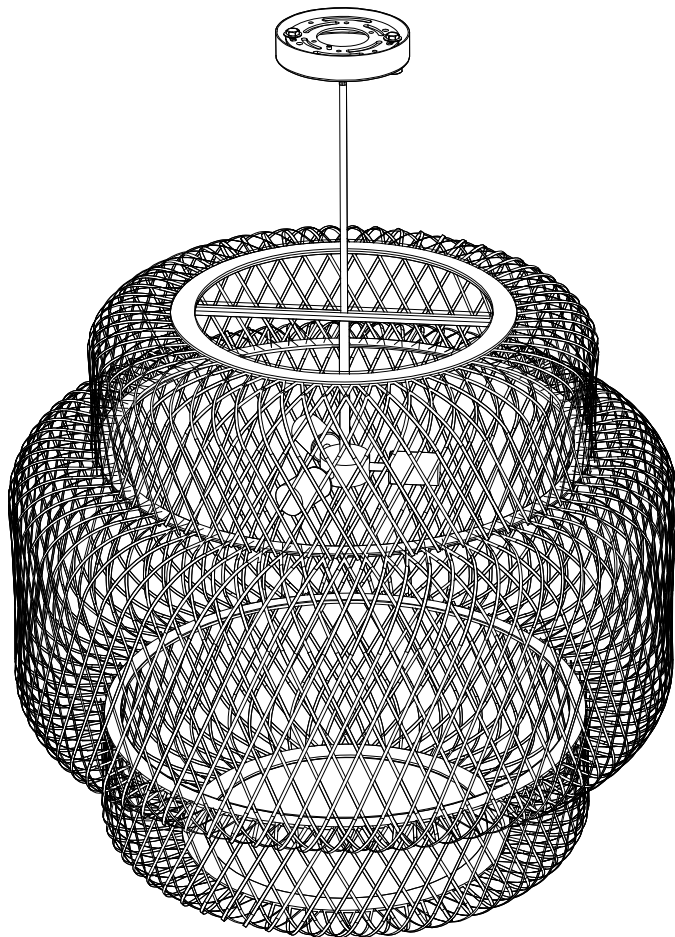

# Safety Rules

---

**WARNING: BE SURE THE ELECTRICITY TO THE WIRES YOU ARE WORKING ON IS SHUT OFF; EITHER THE FUSE IS REMOVED OR THE CIRCUIT BREAKER IS TURNED OFF. TURNING THE POWER OFF USING THE LIGHT SWITCH IS NOT SUFFICIENT TO PREVENT ELECTRICAL SHOCK.**

**NOTE:** The important safeguards and instructions appearing in this manual are not meant to cover all possible conditions or situations that may occur. It must be understood that common sense, caution, and care, are factors which cannot be built into any product. These factors must be supplied by the person(s) installing this unit.

## **READ & SAVE THESE INSTRUCTIONS**

**CAUTION:** Before assembling the lighting fixture, refer to the section titled Wiring Connections. If you feel you do not have enough electrical wiring experience, either refer to a do-it-yourself wiring handbook or have your lighting fixture installed by a qualified, licensed electrician.

## **INSTALLATION & OPERATION INSTRUCTIONS GENERAL**

Before starting the installation, disconnect the power by turning off the circuit breaker or by removing the appropriate fuse at the fuse box. Turning the power off using the light switch is not sufficient to prevent electrical shock.

All electrical connections must be in accordance with local and National Electrical Code (NEC) standards. If you are unfamiliar with proper electrical wiring connections, obtain the services of a qualified electrician.

# Installation Preparation

---

## Tools You Need

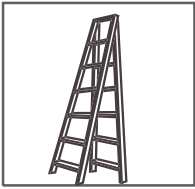

Ladder

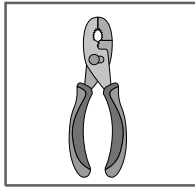

Pliers

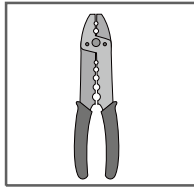

Wire Strippers

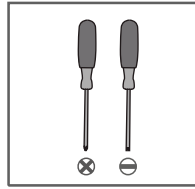

Screwdrivers

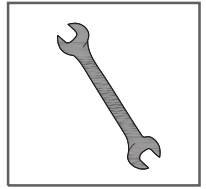

Wrench

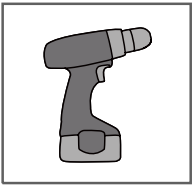

Power Drill  
(optional)

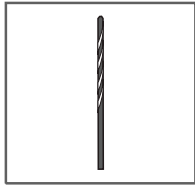

Drill Bit  
(optional)

## What to Expect with your Installation



Check the box to see the weight of the light

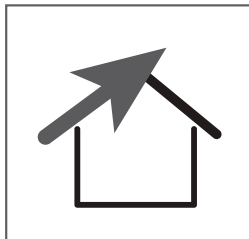





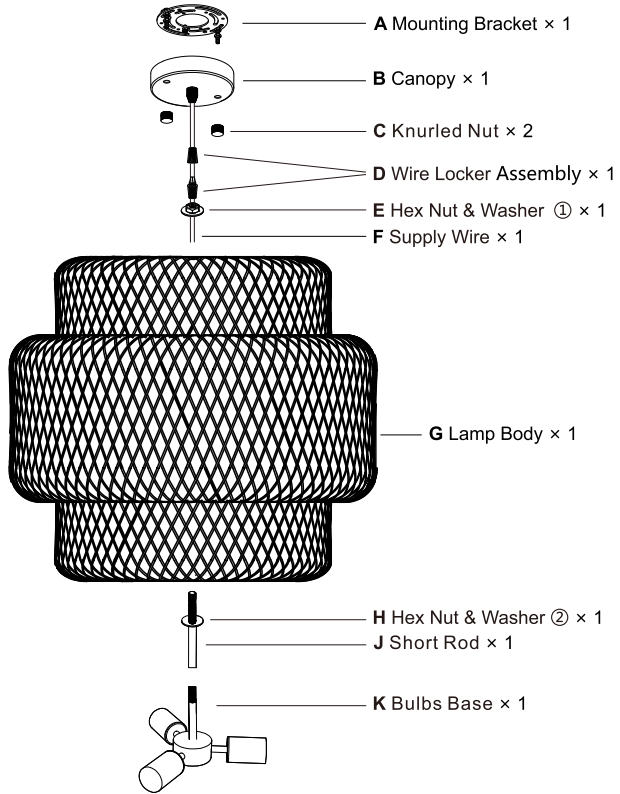

Angled ceiling applicable

# Packing List



## Installation Kit

AA	3x	BB	2x	CC	2x	DD	2x
							
Wire Nut		Outlet Box Screw		Wood Screw		Washer	
EE	2x	FF	1x	GG	1x		
							
Plastic Anchor		Wrench		Gloves			

### NOTE:

1. The listed quantity is for installation, extra hardware may be included.
2. The knurled nuts (C) have already been pre-installed on the canopy(B).
3. The wire locker assembly (D) and hex nut & washer assembly ① (E) are pre-installed on the supply wire(F).
4. The hex nut & washer assembly ② (H) are pre-installed on the short rod(J).

# Installation Instructions

## 1. Remove the Mounting Bracket

Loosen the knurled nuts (C) on the canopy (B), and take out the mounting bracket (A).

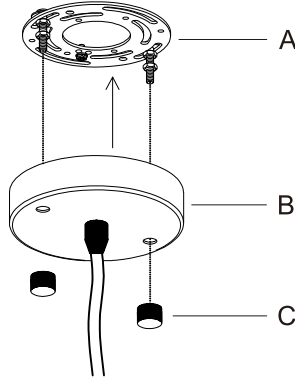

## 2. Mount the Bracket (3 Options)

### Option1. (For Outlet Box)

Secure the mounting bracket (A) to the outlet box with screws taken off from outlet box or screws (BB) and washers (DD) provided.

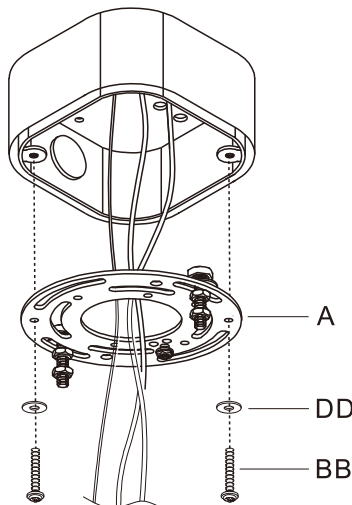

### Option 2. (For Solid Wood Structure)

Mark and drill the screw holes on the solid wood structure.

Mount the mounting bracket with screws (CC) and washers (DD).

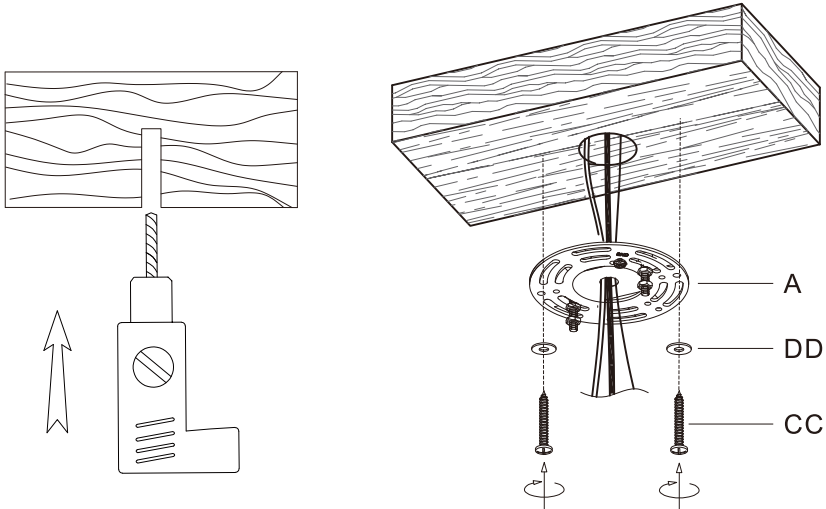

### Option 3. (For Concrete Structure)

Mark and drill the anchor holes on the concrete structure, and then insert the anchors (EE).

Mount the mounting bracket to the concrete structure with wood screws (CC) and washers (DD).

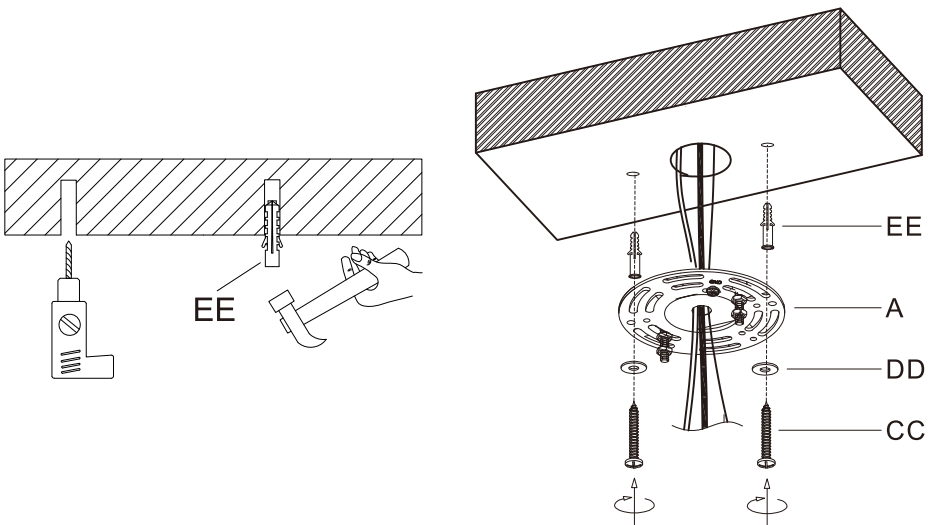

### 3. Connect the Wires

**Step 1:** Connect the wires from the fixture to the house supply wires with wire nuts (AA), neutral wire (white) to neutral wire, and hot wire (black) to the hot wire. Wrap the connection with electrical tape.

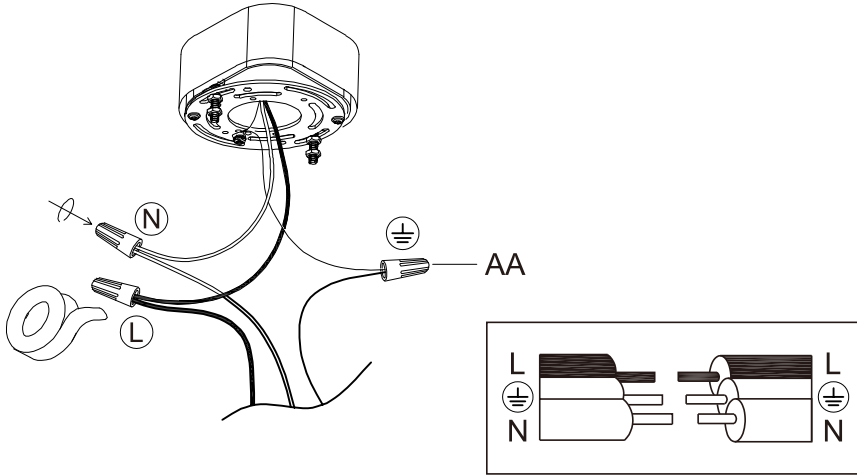

**Step 2:** Attach the canopy (B) to the mounting bracket (A), then secure with knurled nuts (C).

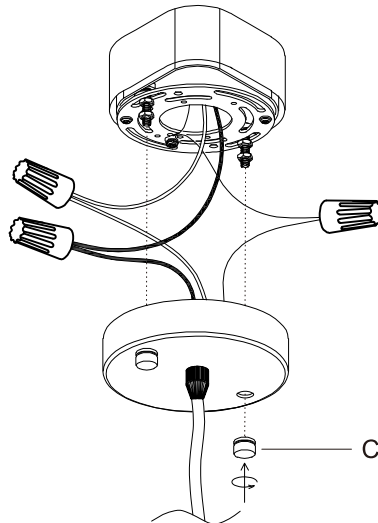

## 4. Install Fixture

**Step 1:** Secure the lower end of the short rod (J) it into the bulbs base (K) connection.

**Step 2:** Pass the upper end of the short rod (J) through the hole in the lampshade crossbar.

**Step 3:** Using a wrench (FF), secure the hex nut and washer assembly (E&H) attached to the supply wire to the short rod.

**Step 4:** Fasten the wire locker assembly (D) to the supply wire.

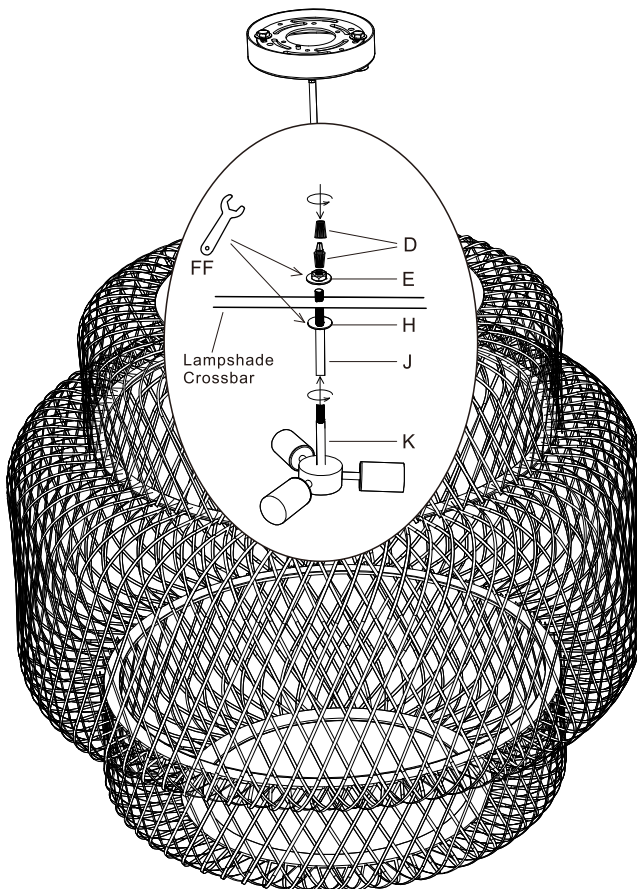

## 5. Install the Bulbs

Install Bulbs (E26 LED Bulbs x 3, max 9W each, not included).

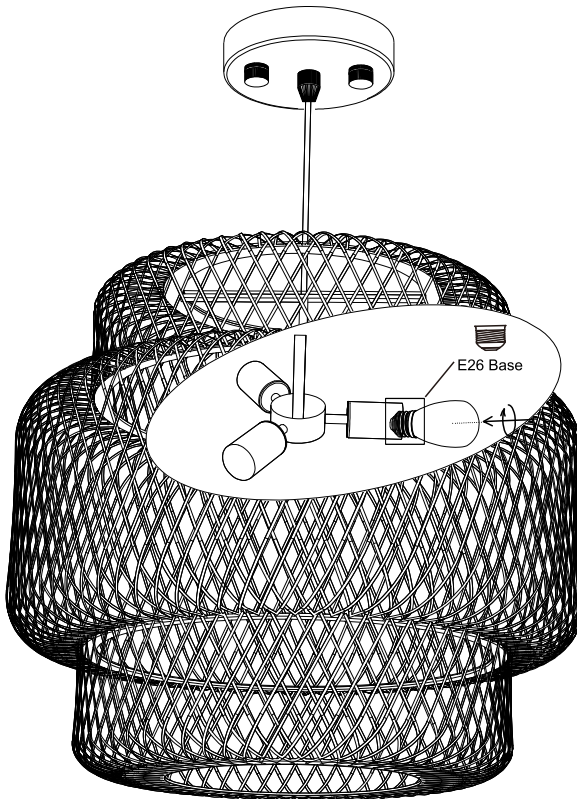

### Note:

- 1、 This lamp has an E26 base and is recommended for use with LED bulbs of 7W to 9W.
- 2、 To achieve dimming functionality, you need to use dimmable bulbs and a dimmer switch.
- 3、 For bulbs with color temperature control, repeatedly switch “on” and “off” using the wall switch to change settings.

# Trouble Shooting

---

## **1. Missing / Broken Parts**

- Make a list of the missing/broken parts according to the packing list, take photos for broken parts, then email us for free replacements.

## **2. Bulbs Do Not Light Up**

- Check your power and switch to make sure it's power on.
- For regular bulbs, make sure it is connected to the ON/OFF wall switch, not the dimmer switch.
- Replace the bulb with a new one.

## **3. Bulbs Flicker**

- If it is a dimmer switch, use a dimmable bulb.
- Replace the bulb with a new one.

## **4. Could Not Install / Assemble**

- Take photos of the ceiling / fixture, contact seller for technical support.

## **Clean And Care**

---

To clean, wipe the fixture with a soft cloth. Spraying from chemical cleaners can discolor the finish of the fixture.

Do not use scouring pads, powders, steel wool, or abrasive paper to clean this fixture.

## **Ordering Parts**

---

Keep this manual for future reference, and in case replacement parts are needed. Available parts can be ordered from the place of purchase. Use exact wording from diagrams when ordering parts.