

Assembly Instructions

Note: Please help to read my instruction before you ready to assemble.

Sofa

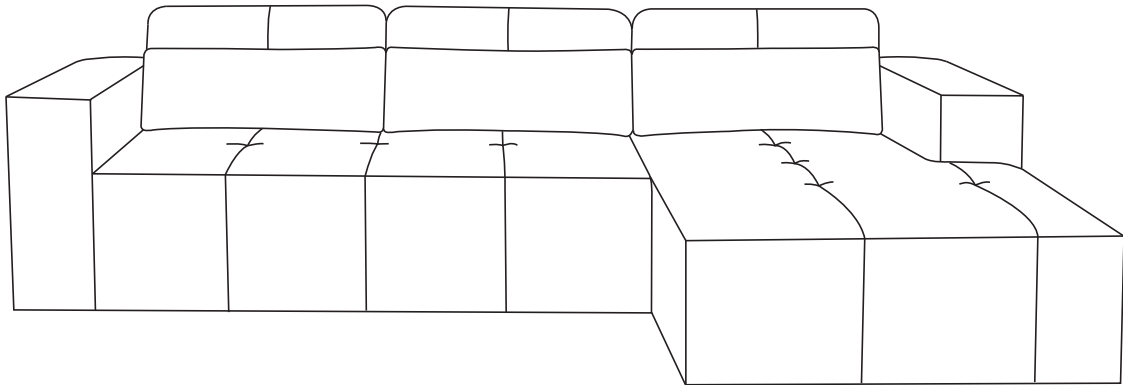

TIPS:

1. The sectional sofa comes in 2 separate boxes, might be delivered at different times. Please wait several days patiently.
2. Due to differences of light effects, the actual color of the materials might be slightly different from the pictures.
3. No Assembly Required. This sofa can free of your stereotyped nightmare of furniture assembly.
4. Due to package compression for better shipment, the fabric may have wrinkles.
5. Please take all packages out and pat every part to make it rebound better and fluffy, so that it can restore to picture-like status.
6. Please keep children away from the plastic bags.

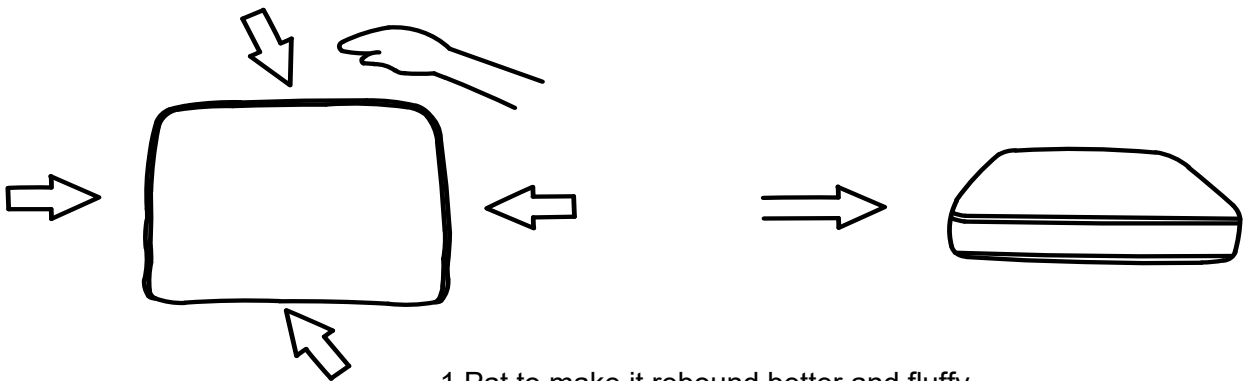

1. Pat to make it rebound better and fluffy.

2. Knead your cushion like giving your cushion a massage while allowing the air to flow through the foam.

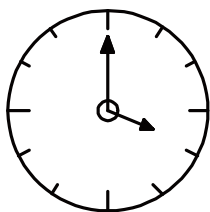



72h

72h

It might takes up to 72 hours.

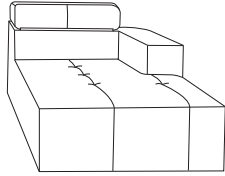
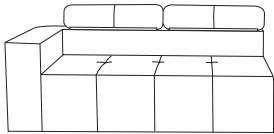
PART LIST:

NO	DESCRIPTION	SKETCH	QTY
A	LOUNGE CHAIR FRAME		1PC
B	TWO-PERSON SEAT FRAME		1PC
C	CUSHION		3PCS

STEP1

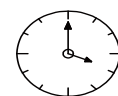
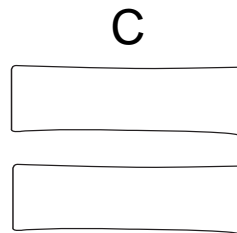
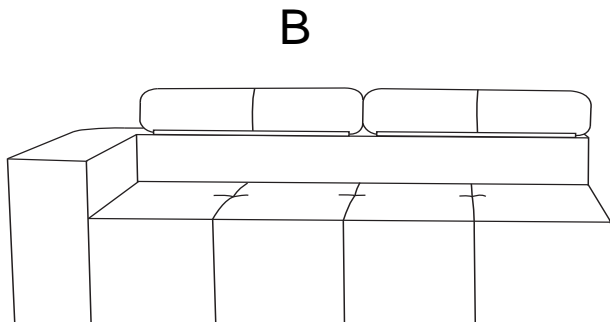
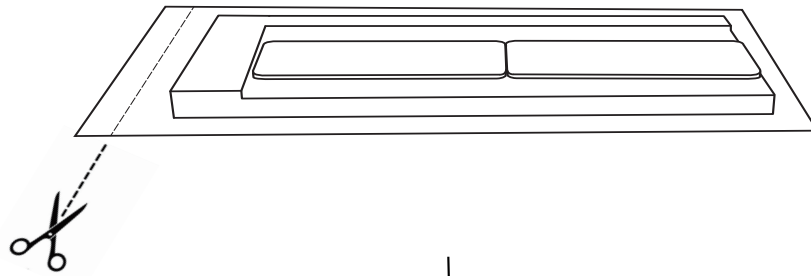

72h

STEP 2

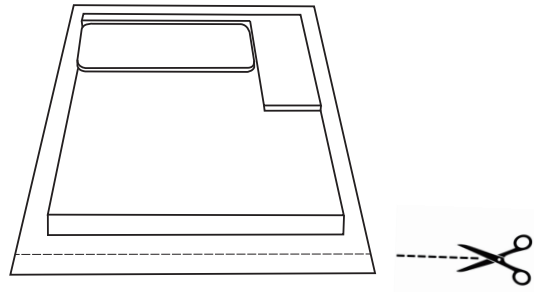

A

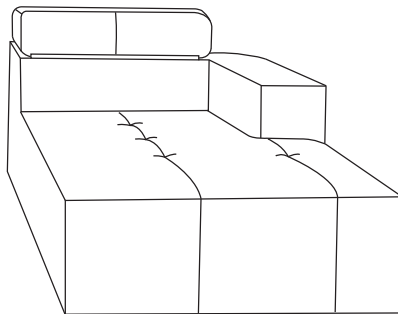

C



72h

STEP 3

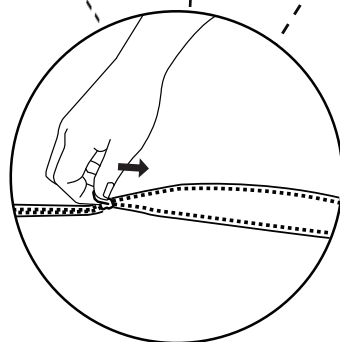
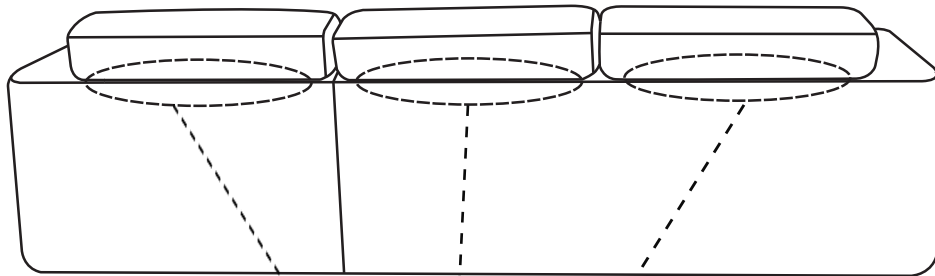

ZIP UP

STEP 4

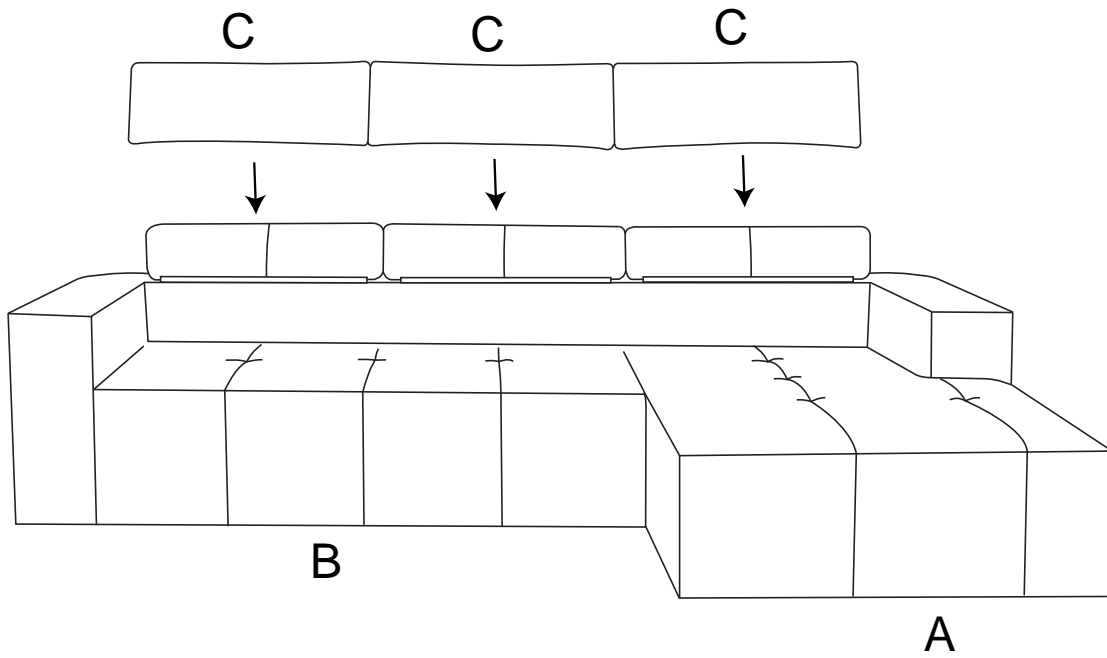



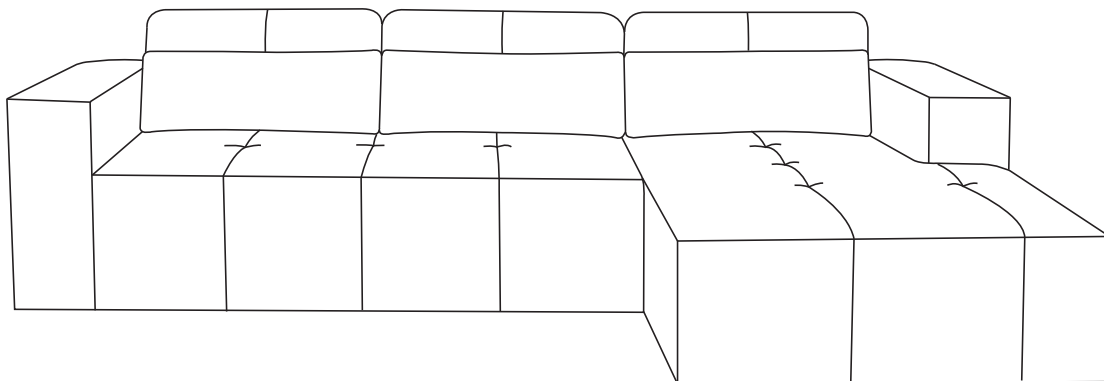







STEP 5



COMPLETE

Care & Maintenance

- ⊘  ● Not for commercial use. For residential use only.
- ✓  ● Furniture may scratch floors. We recommend using furniture pads to protect your floors.
- ⊘  ● Do not put hot items directly on furniture surface.
- ⊘  ● Do not clean furniture with harsh cleansers or polish.
- ⊘  ● Do not place furniture under direct sunlight.
- ⊘  ● Do not place furniture near heating or cooling vents.
- ⊘  ● Do not write on furniture without a padded barrier to protect the surface.
- ⊘  ● Do not place furniture outside . For indoor use only.
- ⊘  ● Stains may be removed with mild soap solution and damp cloth.
- ⊘  ● Children should not climb or jump on the furniture.
- ✓  ● Dust and pick-up spills using a clean, non-colored, lint-free cloth.