



## Kindly Remind

**It is not easy to meet each other in such a big world**

**Thank You for Your Purchase!**

**Dear Valued Customer,**

If you encounter any issues, please contact us. Our support team is here to help.

**Please provide us below information when you contact us:**

1. Purchase order number and platform
2. Problem details( including damage or missing parts number, problem picture)

**Response Hours: In 24 hours**

**Return policy:**

1. Save time and money: Don't return the product without contacting US
2. Don't open all packages if returning, use the original package for return
3. For quality issues, provide images or videos for a quick solution within 24 hours.



# ASSEMBLY INSTRUCTIONS

———— Thank you for choosing our product!

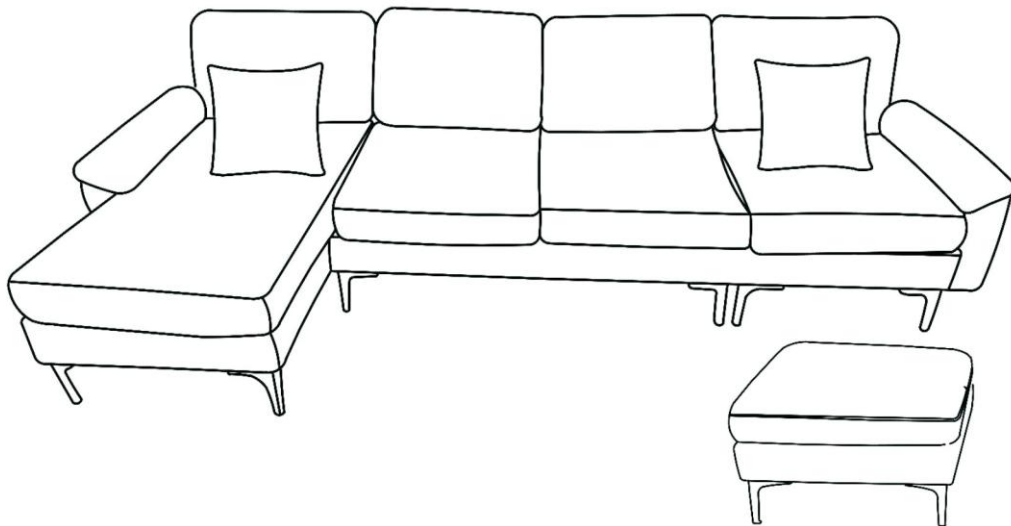









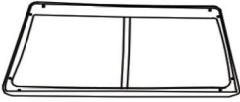
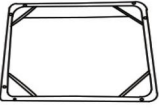
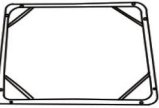
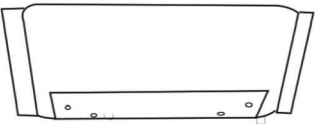
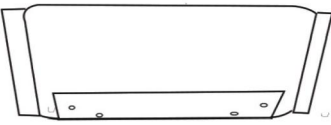

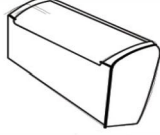
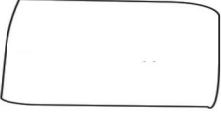

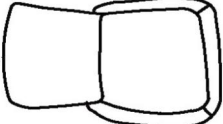

Friendly Reminder:

1. This sofa is packed in 3 boxes. Please assemble it After all boxes are received.
2. As the cushions and pillows are all vacuum compressed, there will be some wrinkles. Please give your cushions up to 72 hours to reach its original size and the wrinkles will basically disappear.
3. Please do not open the compressed package until your sofa frame is completely assembled

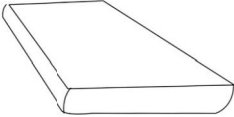
# Assembly Ins truction

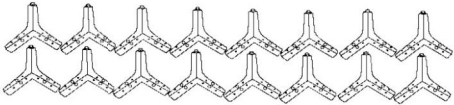
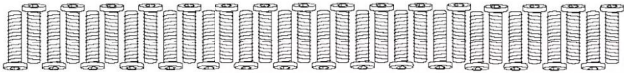
Before installing the sofa, please find out all the accessories. The accessories are usually stored at the bottom of the seat cushion and the zipper position.

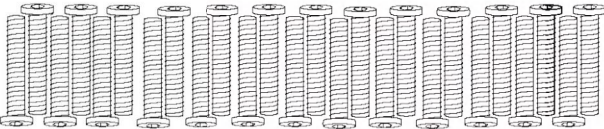
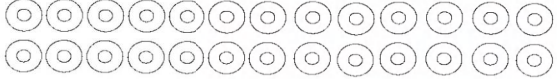
NO	PARTS	QTY
A		1PC
B		1PC
C		1PC
D		1PC
E		3PC
F		1PC
G		1PC
H		1PC
I		1PC
J		3PC
K		1PC
L		1PC
M		3PC

NO	PARTS	QTY
N		1PC
O		3PC
P		1PC
Q		1PC
R		1PC
S		16PC
T		32PC
U		32PC
V		26 PC
W		26PC
Y		1PC
Z		4PC

3 packages: 1/3 :C+D+Q+R+G+H+Z+Screw pack  
2/3 :A+K+L+I+M+S+E+F+N+P  
3/3 :B+J+M+E+S+O+Z

Location of some accessories

**BOX 1**

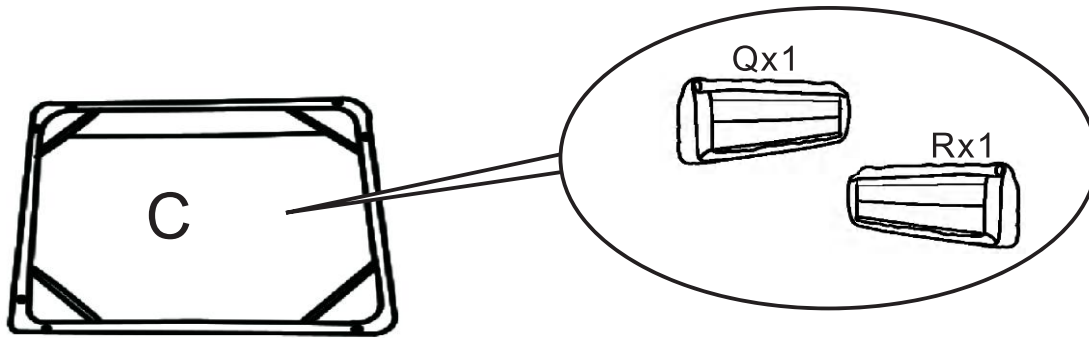

**BOX 2**

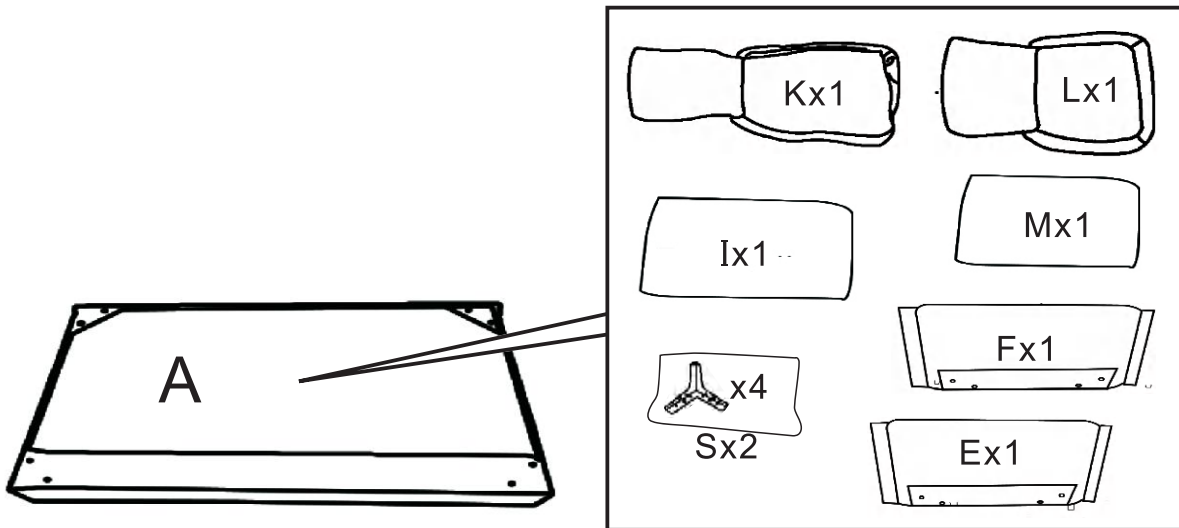

**BOX 3**

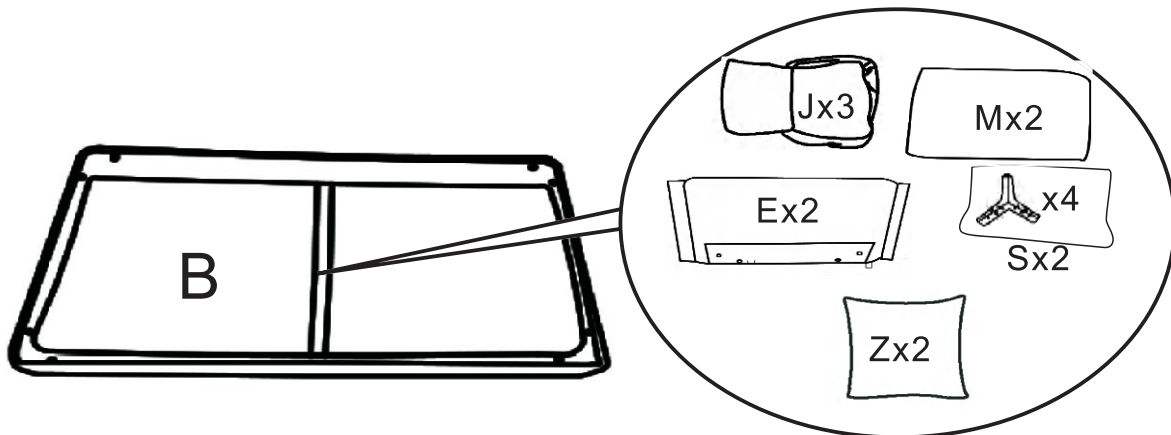

STEP 1

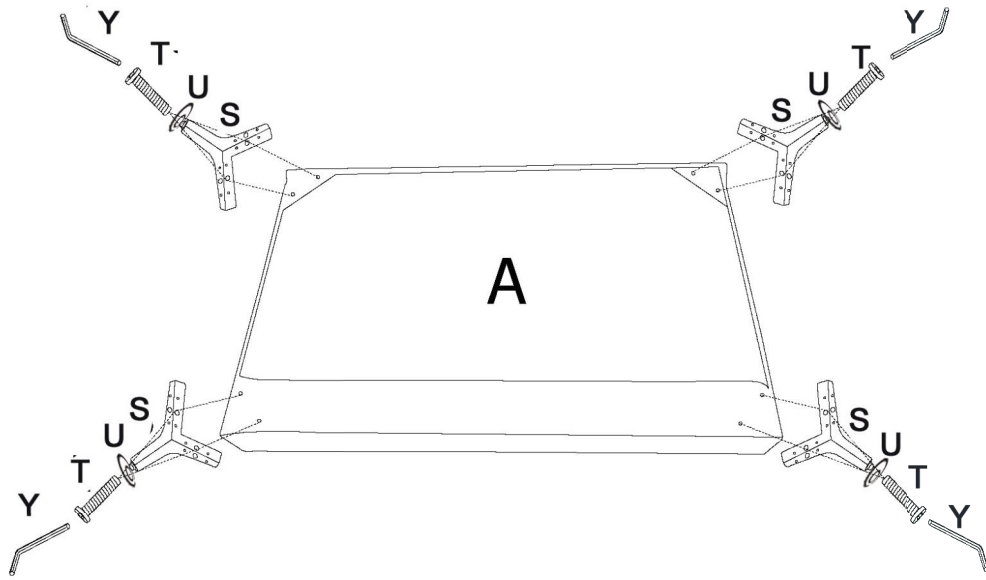

STEP 2

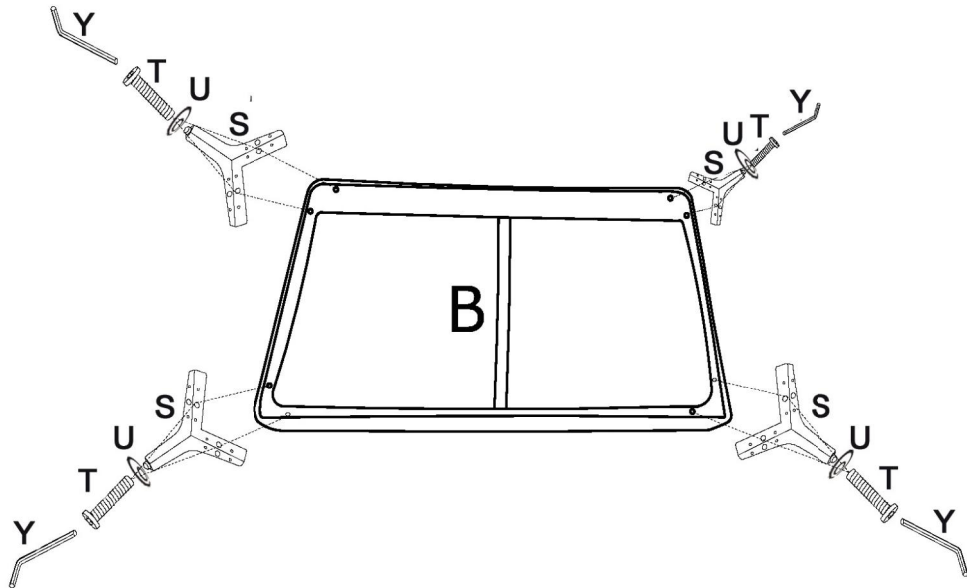

STEP 3

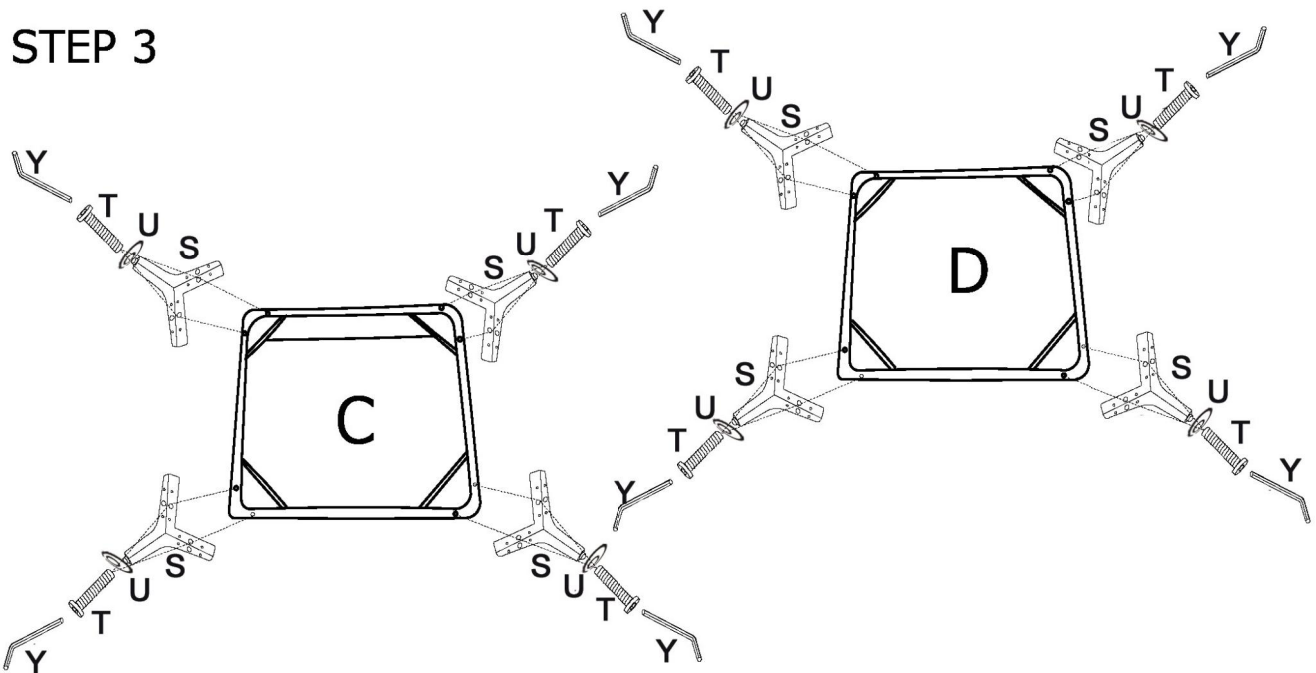

### STEP 4

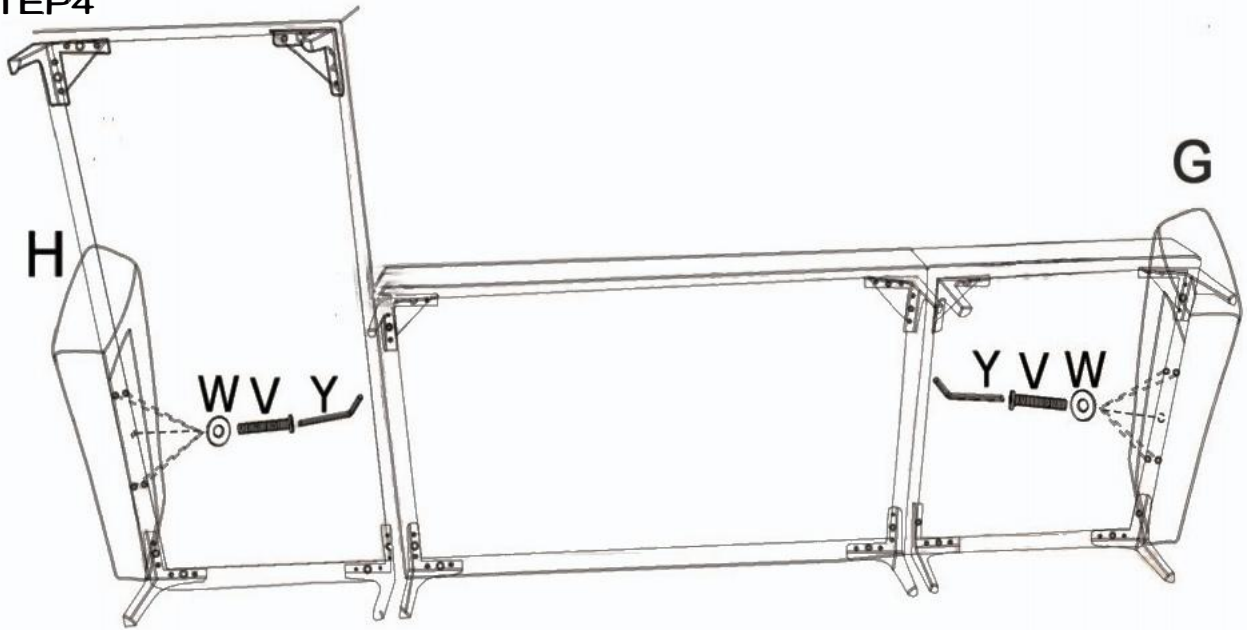

### STEP 5

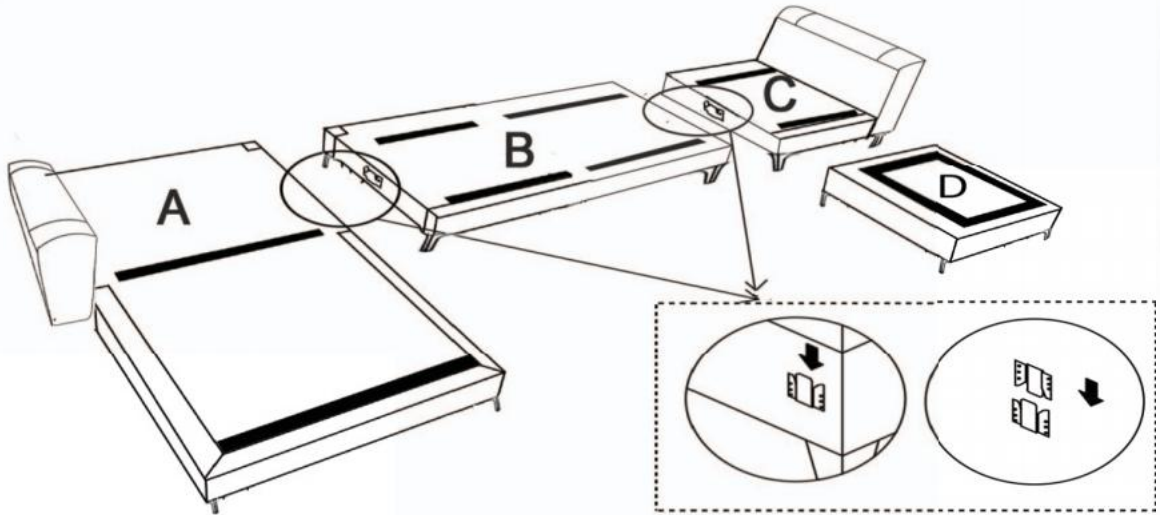

Connect the left seat base(A) and the right seat base(C) to the middle seat base(B) as shown.

### STEP 6

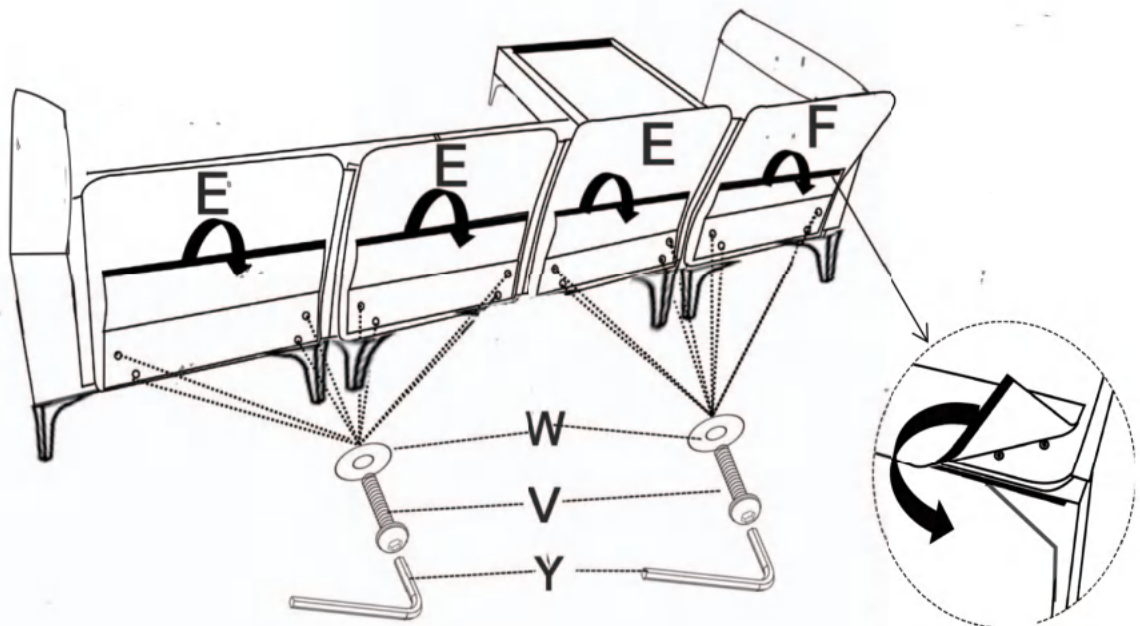

# STEP 7

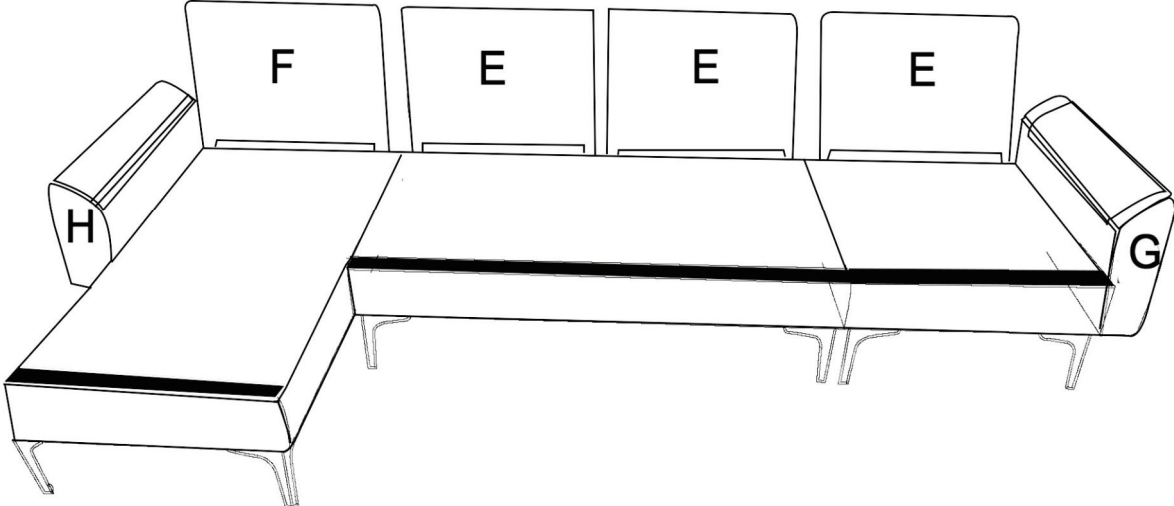

# STEP 8

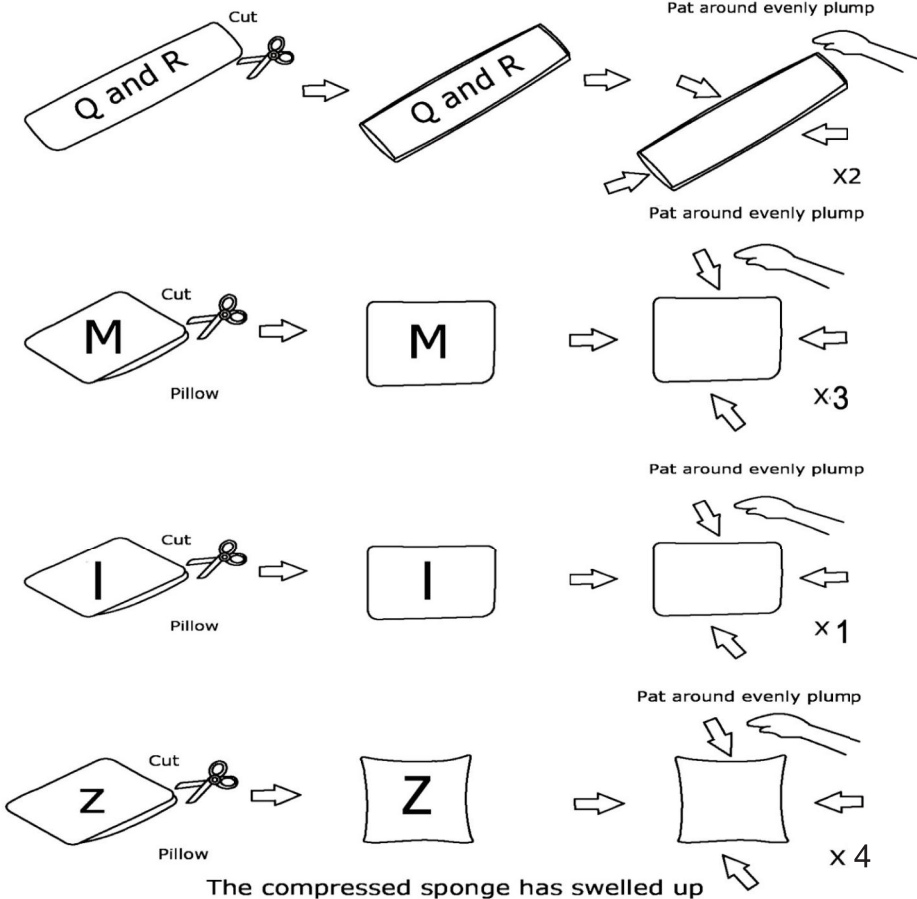

STEP 9

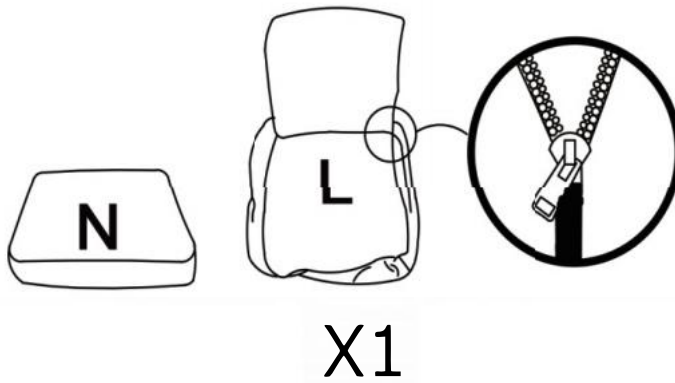
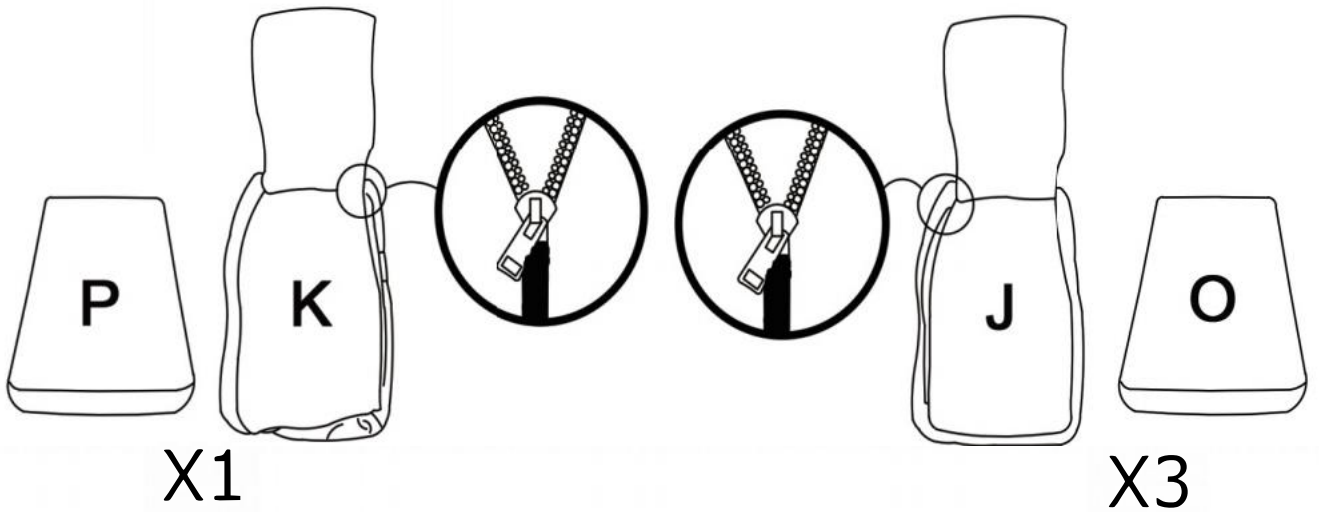
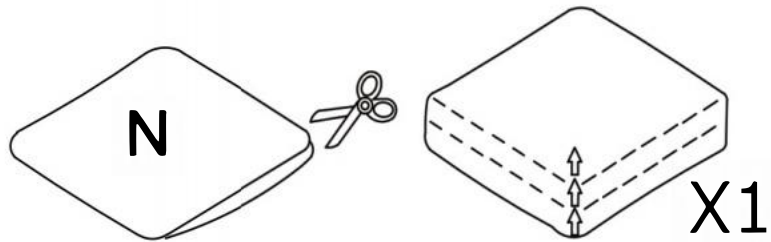
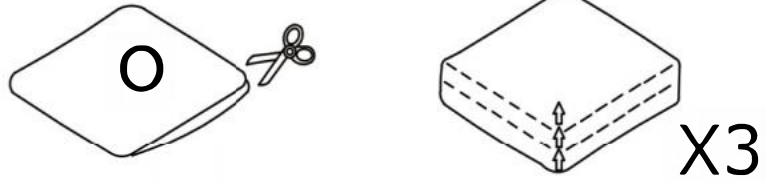
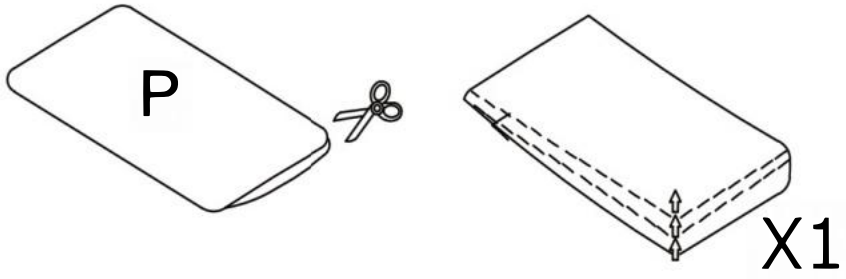

Please align the chain first, then gently squeeze the zipper and close it smoothly.

## STEP 10

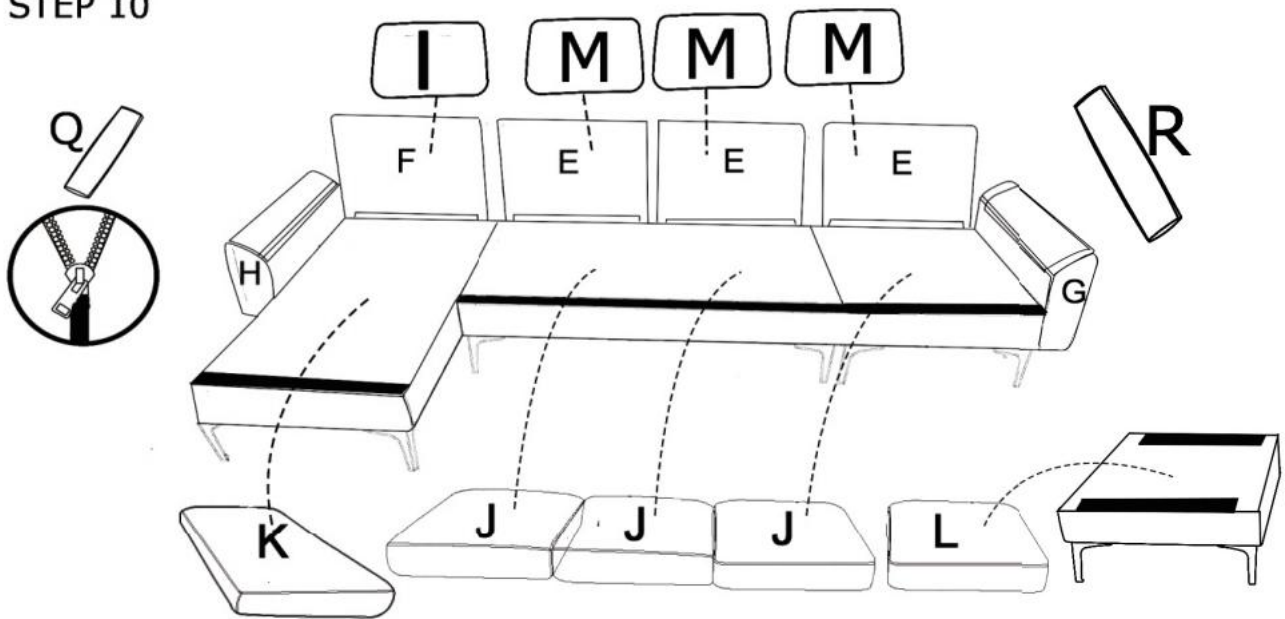

## STEP 11

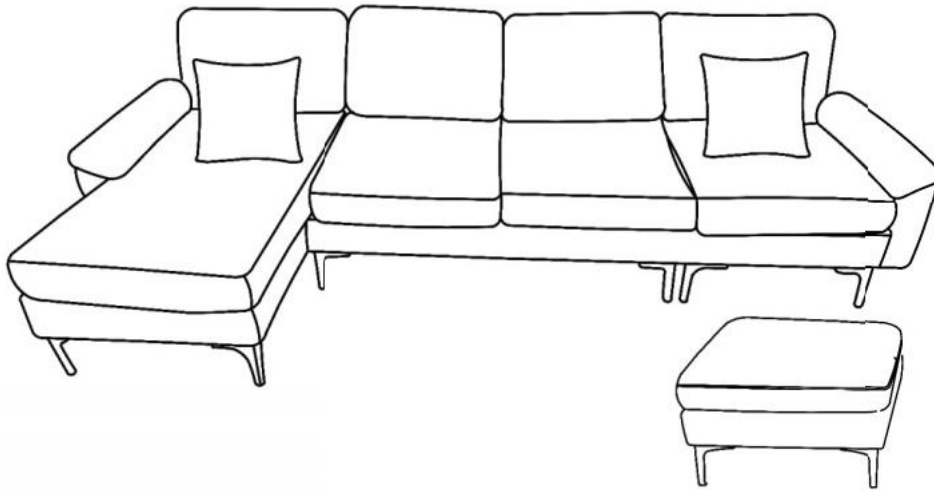

### ATTENTION:

1. please check the manual carefully to make sure you have received all parts.
2. If there are any missing parts, please let us know the letters of the parts you need.
3. If there is any damage, please send us clear photos, we will check it as soon as possible and offer you the best solution.