

The image features a 2x2 grid of red panels. Each panel is a solid red rectangle. At the corners of each panel, there are white L-shaped brackets. The top-left and bottom-right corners of each panel have a single bracket, while the top-right and bottom-left corners have a double-bracket structure. The text 'Panels' and '[Installation Guide]' is centered in the white space between the panels.

Panels

[Installation Guide]

What does my box include?

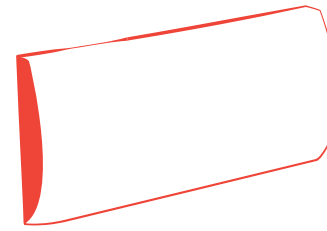

[a]
panels

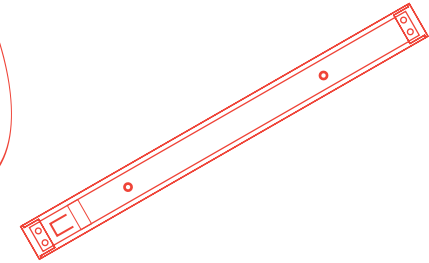

[b]
brackets

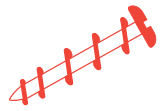

[c]
screws

30" Panel Box







- 4 x panels [a]
- 4 x brackets [b]
- 8 x anchorless screws [c]

39" Panel Box



- 4 x panels [a]
- 6x brackets [b]
- 12 x anchorless screws [c]

[Tools]

-  Screwdriver (Manual or Electric in Low Torque Mode)
-  Measuring Tape
-  Level
-  Pencil

ready?

[Prep]

Remove all packaging from brackets.

Note: The patented anchorless screws are designed with extra wide threads to grip the drywall so the panels are firmly held in place. No studs or anchors will be needed when mounting your panels onto drywall.



set.

[STEP 0]



Before you start:

Snap a before picture of your room

Snap

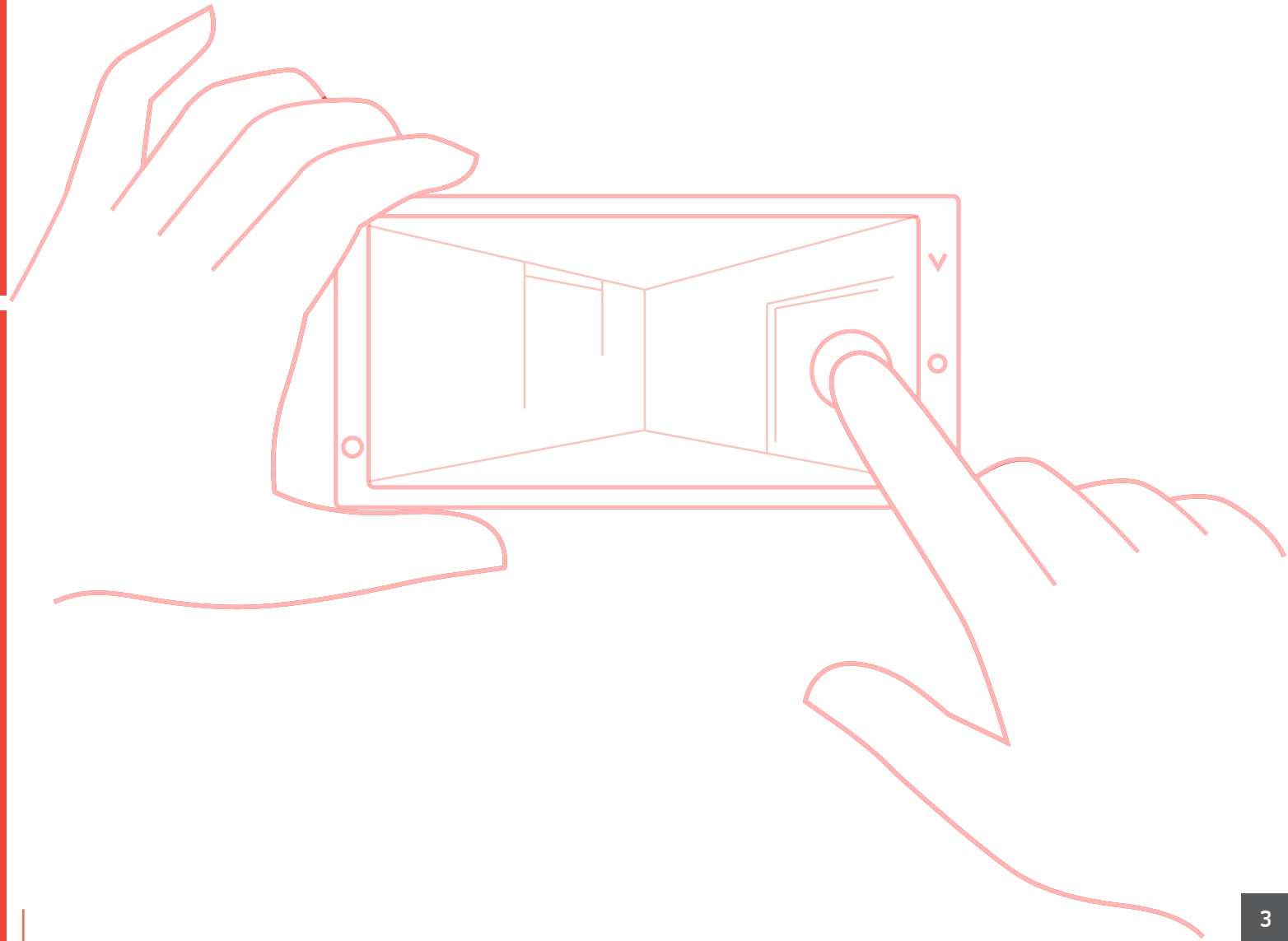

GO!

[STEP 1]

- Using your measuring tape, find and mark the center point of the surface that you want your Vânt Wall Panels to cover. This is often the center of your wall or bed. Use your Level to draw a straight vertical line to indicate where you want your panels to start.



DO NOT mount the brackets onto the wall yet, make sure to read the following steps.

[STEP 2]

- Position your first Vânt wall panel on the floor, backside up.
- Press and snap one bracket at a time with the stopper side down onto the panel clips.

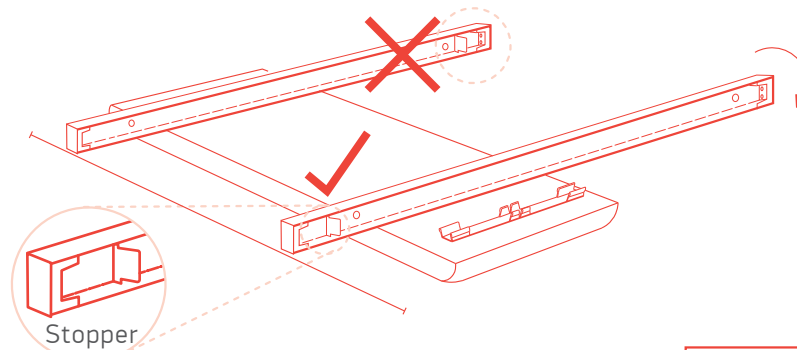

(Use two brackets for a 30" panel set; three brackets for a **39"** panel set.)



Snap away from the stopper, and then slide up until you hit the stopper

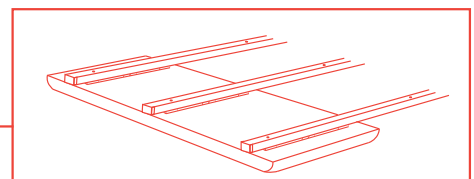
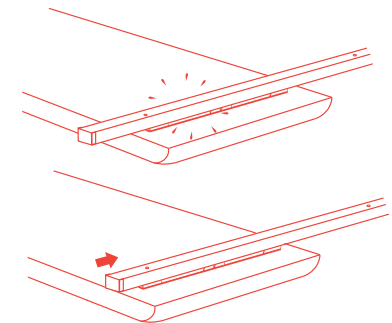

[STEP 3]

- Once all brackets are connected to your first panel, lift the assembly and position it against your wall at your mark.

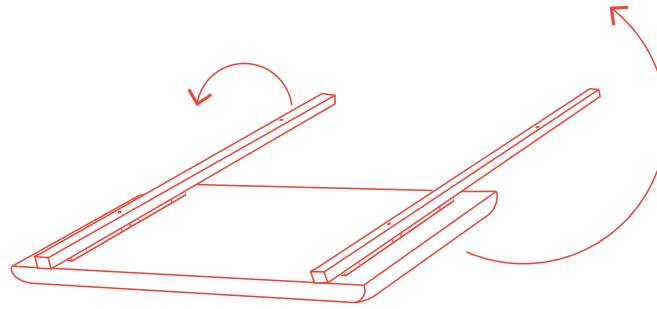

keep going



Having an extra hand is helpful when installing 39" panels to hold all brackets in place.

[STEP 4]



Before fastening anything in place, double check with your finger that the panel is flush with bottom of the brackets.

- With everything aligned, drive one of the included anchorless screws into the first bracket hole directly above the panel.
- Repeat for the opposite hole.



IMPORTANT: (If using an electric drill, place the torque on low and drill gently, so the drywall hole doesn't get worn out.)



Use a leveling tool to make sure your panels are level before installing.

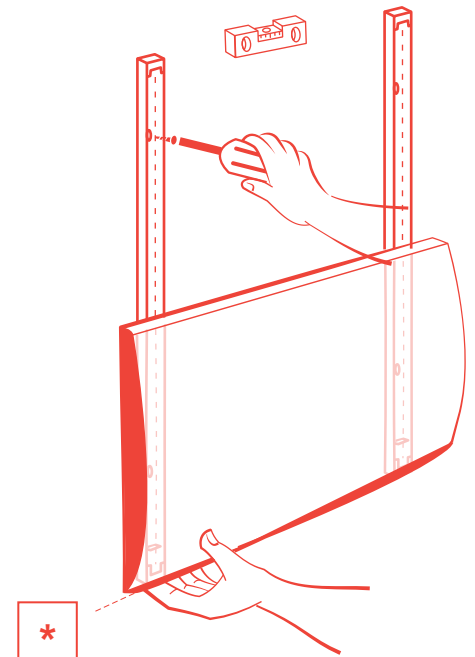
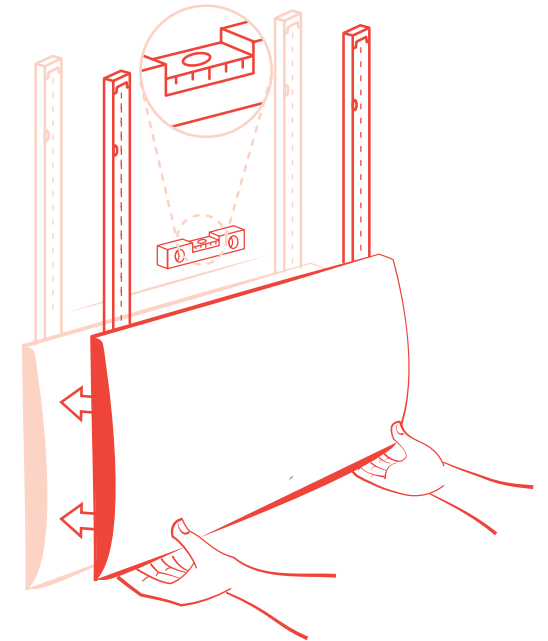

almost there

[STEP 5]

- With two screws secured above your first panel, slide the panel up and insert two screws in the bottom holes and then slide the panel back down.

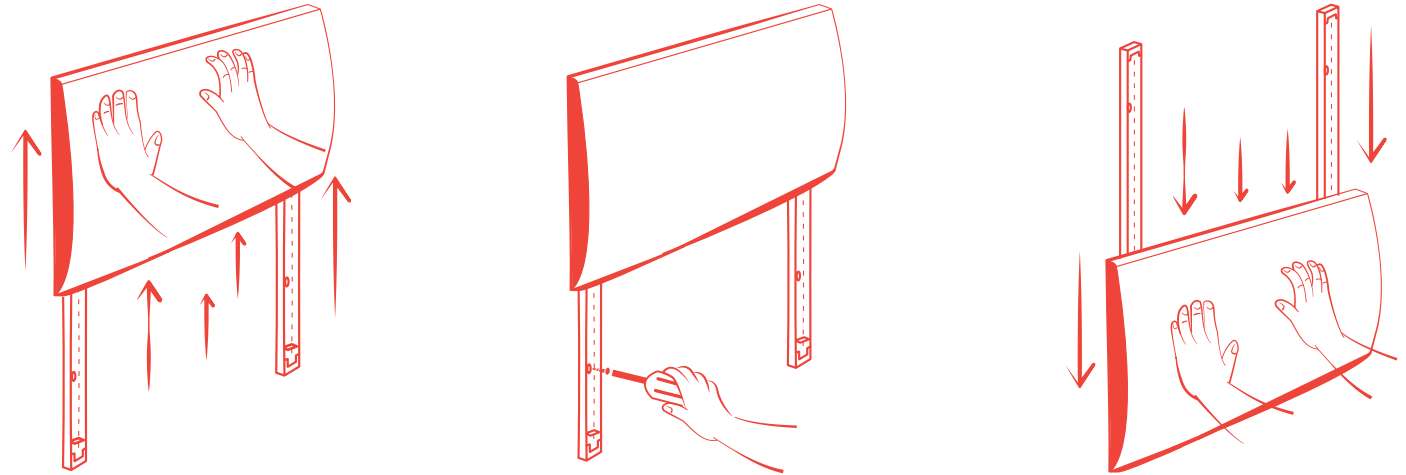

[STEP 6]

- Next, align your second panel right above the first panel and simply push it inwards until it clicks.

*

Make sure the clips are perfectly aligned with the bracket openings by feeling with your fingers.

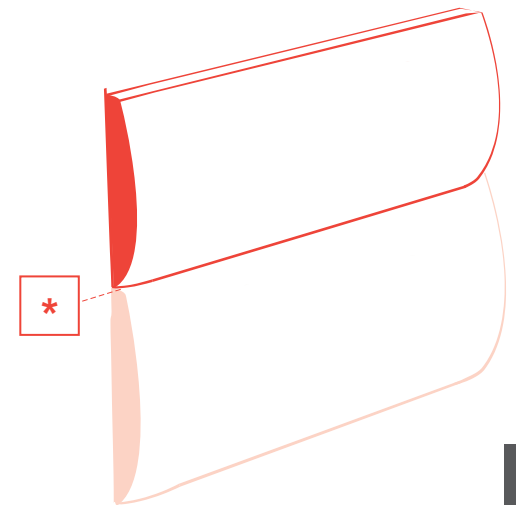
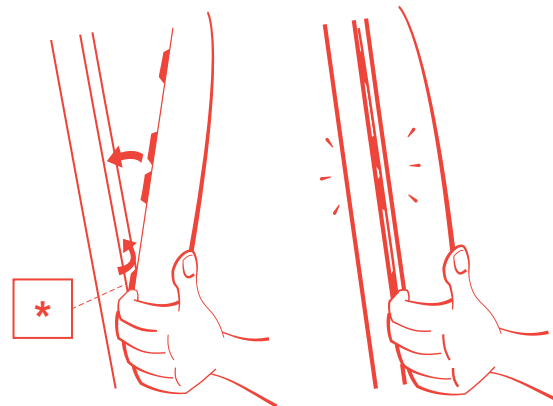

[STEP 7]



Use a leveling tool to make sure your panels are level before installing.

- Repeat steps 2, 3, 4, 5 & 6 to add more panels vertically and/or side-by-side.
- To prevent any spacing between columns or rows, apply gentle pressure towards the existing column/row from the side or from below when installing the next panel.

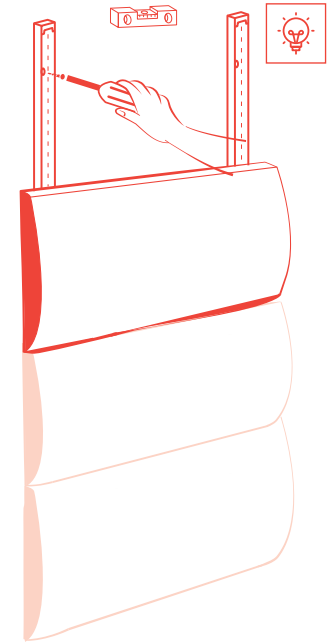
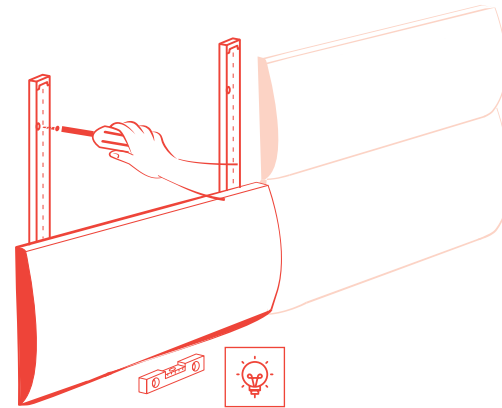

DONE!

almost done! 

Snap an after picture to share with family and friends

#myvant



Welcome to the vânt look!

i'll share

FAQ

[Got questions? We have answers]

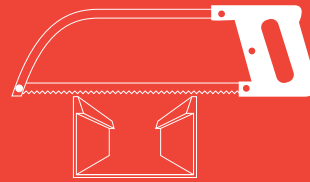

Mounting 3 Panels High

Each aluminum bracket is designed to fit 2 panels. If you want to add a third panel, you can cut the bracket in half with a hacksaw the size to fit one panel.

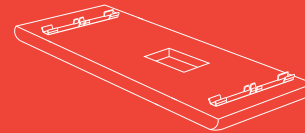

Cut-out for an outlet

To cut-out for an outlet, measure for the placement of the outlet on your panel and mark your cut-out the size of your outlet/switch. Gently cut through the wood with a jigsaw and through the upholstery with a razor knife. Pull your electrical box through the opening and then place your cover on just as on a regular wall.

