

MODEL: IG10600047C-1224N2

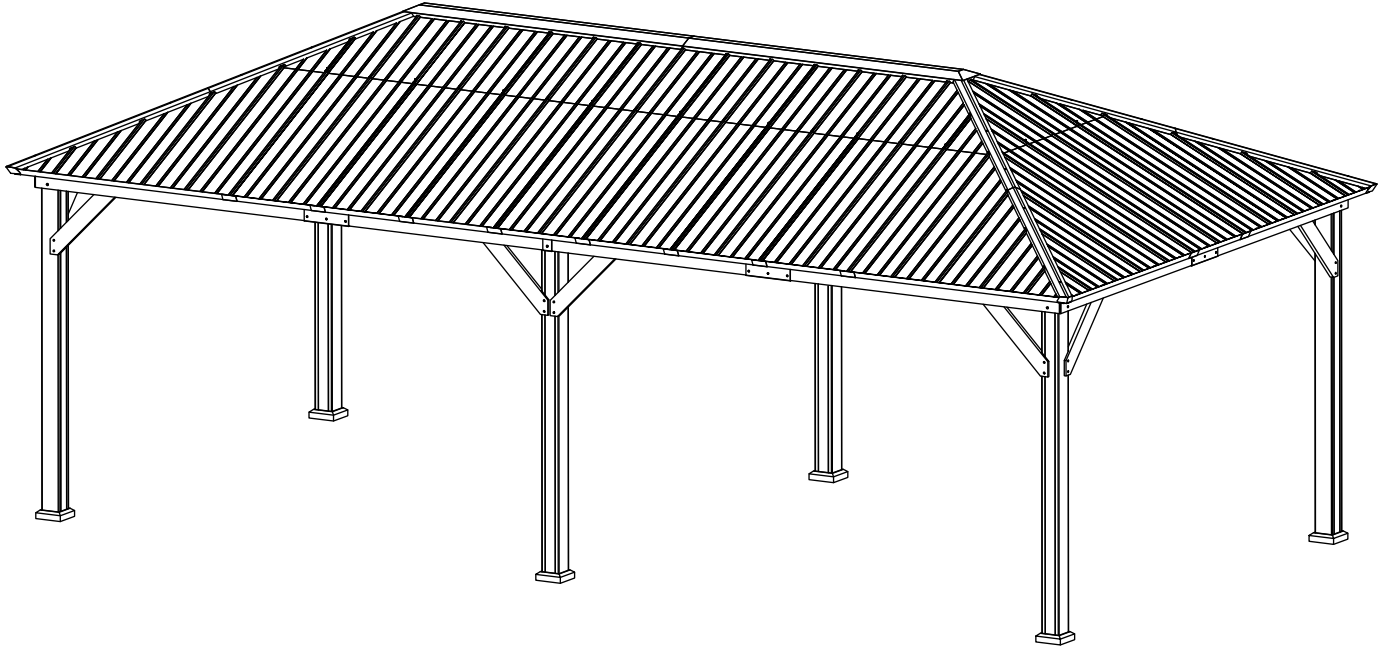

OWNER'S MANUAL

Tranquil Grove 12'x24' Cedar Framed Hardtop Pavilion

TABLE OF CONTENTS

ASSEMBLY GUIDE.....02
USING YOUR PRODUCT.....05

November 14, 2025

QUESTIONS?









 **E-mail:** support@modernshade.org

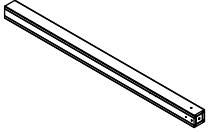
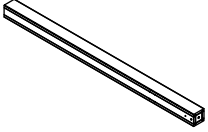
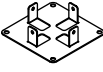

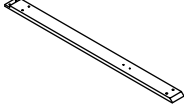
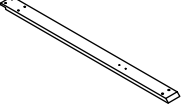
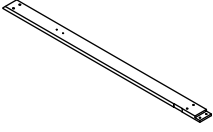
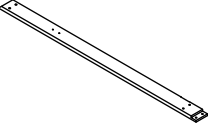
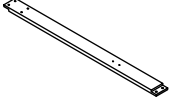
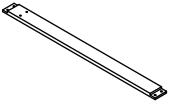
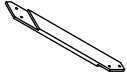
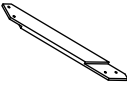
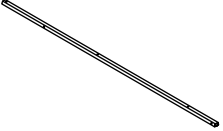
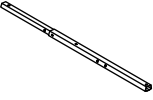



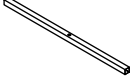
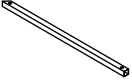
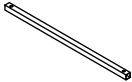

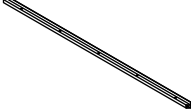
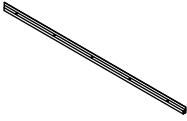
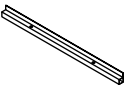
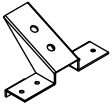
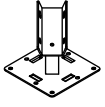
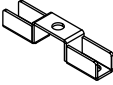
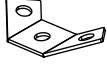
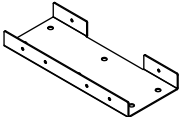
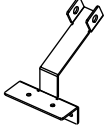
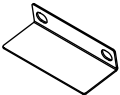
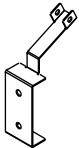
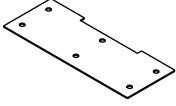
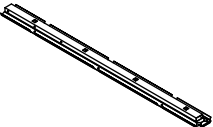
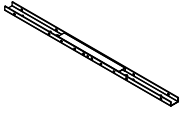
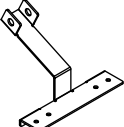



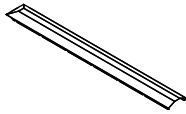
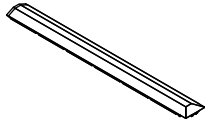
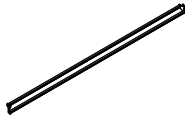





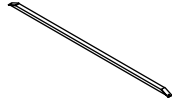

 **Toll Free Number:** 1-888-666-3070

 **Mon-Fri:** 9:00 AM - 5:00 PM PST.



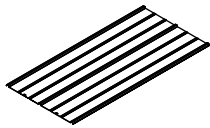

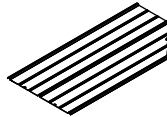

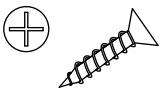
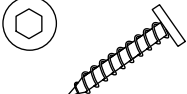
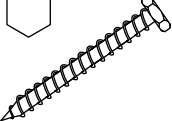
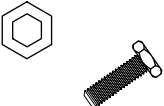
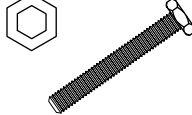
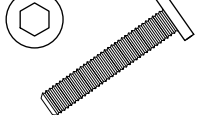
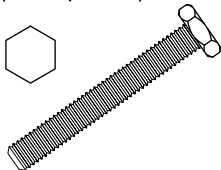
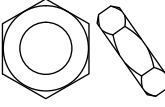

ASSEMBLY GUIDE

PARTS LIST

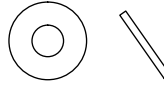
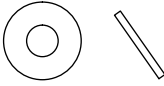
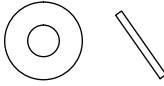
A1 Post 1 (4pieces) 	A2 Post 2 (2pieces) 	B1 Foot Base 1 (6pieces) 	C1 Foot Cover 1 (6pieces) 	D3 Cross Beam 3 (2pieces) 	D4 Cross Beam 4 (2pieces) 
P0010000701	P0010000801	P0030000301	P0020000301	P0040016101	P0040016201
D15 Cross Beam 15 (2pieces) 	D16 Cross Beam 16 (2pieces) 	D17 Cross Beam 17 (2pieces) 	D18 Cross Beam 18 (2pieces) 	E1 Support Bracket 1 (6pieces) 	E2 Support Bracket 2 (6pieces) 
P0040019801	P0040019901	P0040020001	P0040020101	P0050000501	P0050000601
F4 Roof Rib 4 (4pieces) 	F5 Roof Rib 5 (4pieces) 	G4 Middle Cross Beam 4 (12pieces) 	G5 Middle Cross Beam 5 (4pieces) 	G6 Middle Cross Beam 6 (4pieces) 	H1 Roof Support 1 (16pieces) 
P0070000501	P0070000601	P0080000501	P0080000801	P0080000901	P0090014801
H2 Roof Support 2 (8pieces) 	H3 Roof Support 3 (16pieces) 	H8 Roof Support 8 (8pieces) 	J1 Roof Border 1 (4pieces) 	J2 Roof Border 2 (4pieces) 	J3 Roof Border 3 (16pieces) 
P0090000202	P0090014901	P0090002201	P0090015001	P0090015101	P0090015201
K1 Connector 1 (20pieces) 	K2 Connector 2 (4pieces) 	K3 Connector 3 (60pieces) 	K4 Connector 4 (12pieces) 	K5 Connector 5 (6pieces) 	K6 Connector 6 (4pieces) 
P0060001501	P0060001701	P0060000501	P0060000602	P0110005301	P0060005001
K7 Connector 7 (20pieces) 	K8 Connector 8 (2pieces) 	K11 Connector 11 (6pieces) 	K21 Connector 21 (2pieces) 	K22 Connector 22 (1piece) 	K26 Connector 26 (2pieces) 
P0110000502	P0060008301	P0110005401	P0060008101	P0060008201	P0060011901

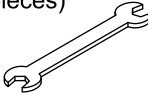
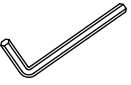
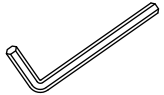
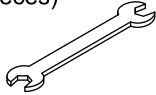
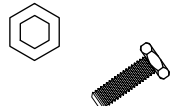
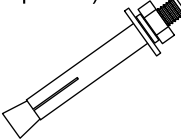
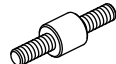
<p>L9 Roof Rib Cover 9 (4pieces)</p> 	<p>L10 Roof Rib Cover 10 (4pieces)</p> 	<p>L11 Roof Cover 11 (1piece)</p> 	<p>L12 Roof Cover 12 (1piece)</p> 	<p>M1 Mosquito Net Rod 1 (2pieces)</p> 	<p>M2 Mosquito Net Rod 2 (2pieces)</p> 
P0120001001	P0120001101	P0120004301	P0120004401	P0100002801	P0100002901
<p>M3 Mosquito Net Rod 3 (2pieces)</p> 	<p>M4 Mosquito Net Rod 4 (2pieces)</p> 	<p>M5 Mosquito Net Rod 5 (4pieces)</p> 	<p>N Hook (1piece)</p> 	<p>P3 Middle Cross Beam Support 3 (6pieces)</p> 	<p>Z4 Roof Plate 4 (4pieces)</p> 
P0100001601	P0100001701	P0100003001	P1000000100	P0050006801	P0130000499
<p>Z5 Roof Plate 5 (4pieces)</p> 	<p>Z6 Roof Plate 6 (4pieces)</p> 	<p>Z7 Roof Plate 7 (4pieces)</p> 	<p>Z15 Roof Plate 15 (2pieces)</p> 	<p>Z16 Roof Plate 16 (2pieces)</p> 	<p>Z17 Roof Plate 17 (2pieces)</p> 
P0130000599	P0130000699	P0130000799	P0130001599	P0130001699	P0130001799
<p>Z18 Roof Plate 18 (10pieces)</p> 	<p>Z19 Roof Plate 19 (16pieces)</p> 	<p>Z21 Roof Plate 21 (4pieces)</p> 	<p>Z22 Roof Plate 22 (4pieces)</p> 	<p>Z23 Roof Plate 23 (4pieces)</p> 	<p>Z24 Roof Plate 24 (4pieces)</p> 
P0130001899	P0130001999	P0130007099	P0130007199	P0130007299	P0130007399

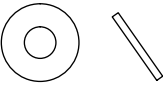
HARDWARE

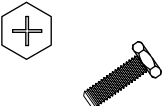
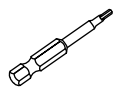
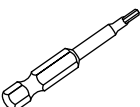
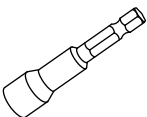
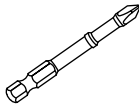
AA Bolt M5*25 (196+10 pieces) 	BB Bolt M8*35 (48+2 pieces) 	CC Bolt M10*65 (10+1 pieces) 	DD Bolt M6*20 (294+16 pieces) 	EE Bolt M6*45 (24+2 pieces) 	FF Bolt M8*45 (36+2 pieces) 
H0008008098	H0008008099	H0008008100	H0008008036	H0008008016	H0008008191
GG Bolt M10*160 (10+1 pieces) 	HH Anti-slip Screw Nut M10 (10+1 pieces) 	JJ M8 Ball nut (36+2 pieces) 	KK M6 Flat washer (458+25 pieces) 	LL M8 Flat washer (120+6 pieces) 	MM M10 Flat washer (30+2 pieces) 
H0008008140	H0008008126	H0008008192	H0008008057	H0008008058	H0008008141
NN M6 Sealant Washer (16+2 pieces) 	PP Double Open End Wrench M8/M10 (2 pieces) 	RR M6 Allen Key (2 pieces) 	SS M8 Allen Key (2 pieces) 	TT Double Open End wrench M5/M6 (2 pieces) 	VV Bolt M6*15 (140+7 pieces) 
H0008008060	H0008008190	H0008008133	H0008008129	H0008008121	H0008008001
XX Concrete Anchor M6*60 (12 pieces) 	YY M5x14 Double head screw (20+1 pieces) 	ZZ M5 Ball nut (20+1 pieces) 	ZY M5 Flat washer (36+2 pieces) 	ZX M5 Sealant washer (36+2 pieces) 	ZV Bolt M5*25 (16+1 pieces) 
H0008008095	H0008008163	H0008008164	H0008008056	H0008008059	H0008008138
ZU M6 Hex drill bit (1 piece) 	ZT M8 Hex drill bit (1 piece) 	ZS M10 Hex socket drill bit (1 piece) 	ZR Phillips drill bit (1 piece) 		
H0008008209	H0008008210	H0008008208	H0008008215		

IMPORTANT:

This instruction manual contains important information necessary for the proper assembly and safe use of the product.

Read and follow all warnings and instructions before assembling and using the product.

Follow all warnings and instructions when using the product.

Keep this manual for future reference.

Installer/Assembler: leave these instructions with the consumer.

SAFETY ALERT KEY

DANGER

Indicates a hazardous situation that, if not avoided, will result in death or serious injury.

WARNING

Indicates a hazardous situation that, if not avoided, could result in death or serious injury.

CAUTION

Indicates a hazardous situation that, if not avoided, could result in minor or moderate injury.

NOTICE

Indicates information considered important, but not hazard-related (e.g. messages related to property damage).

ASSEMBLY INSTRUCTIONS

- Please carefully unpack each of the components and hardware. check the components against the parts list and make sure there are no missing parts. lay pieces on cardboard or a soft mat to help protect the pieces from scratches.

⚠ CAUTION

Watch for sharp edges when handling the pieces, wear gloves to avoid injury.

STEP 01

Slide foot base **B1** and foot cover **C1** onto post **A1** . Use four (4) **[AA]** bolts to attach foot base **B1** to post **A1** . Repeat with the other three (3) posts **A1** and two (2) posts **A2** .

[AA] x24

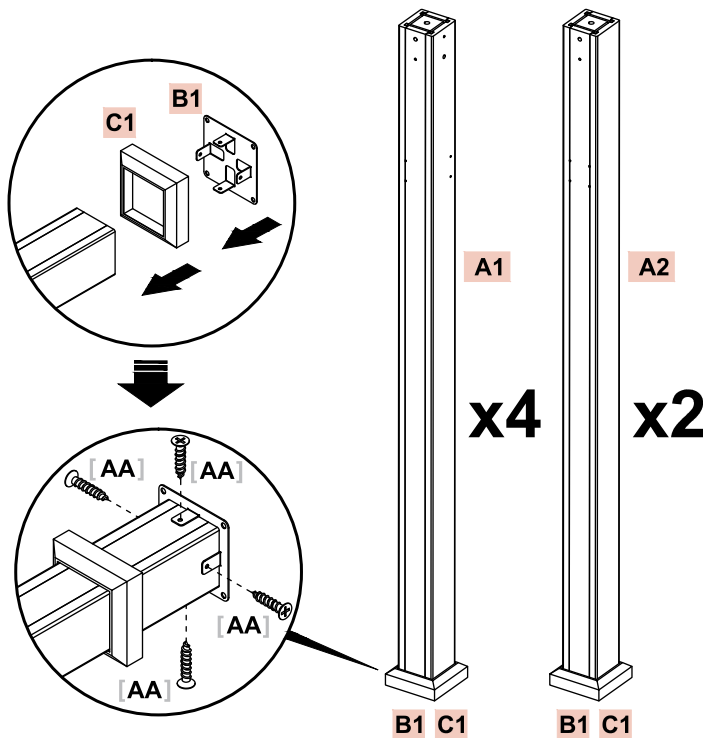

- For ease of assembly, it is recommended to have 3 or more people and allow enough time to completely finish the assembly. assembly can take 6-8 hours. a step-ladder is required for assembly (not included).
- Follow step by step instructions, and follow all safety warnings provided with your tools.
- DO NOT tighten screws until all the screws and washers are properly installed. Tighten screws securely, do not over tighten.
- Gazebo should not be used in inclement weather and high winds.

STEP 02

Attach cross beam **D3** and **D4** together using connector **K5** and **K11** .Secure with six (6) **[FF]** bolts,twelve (12) **[LL]** flat washers and six (6) **[JJ]** ball nuts on the sides. Use six (6) **[AA]** bolts secure both the top and bottom of the connection. Repeat to make a second assembly.

[AA] x 12

[FF] x 12

[JJ] x 12

[LL] x 24

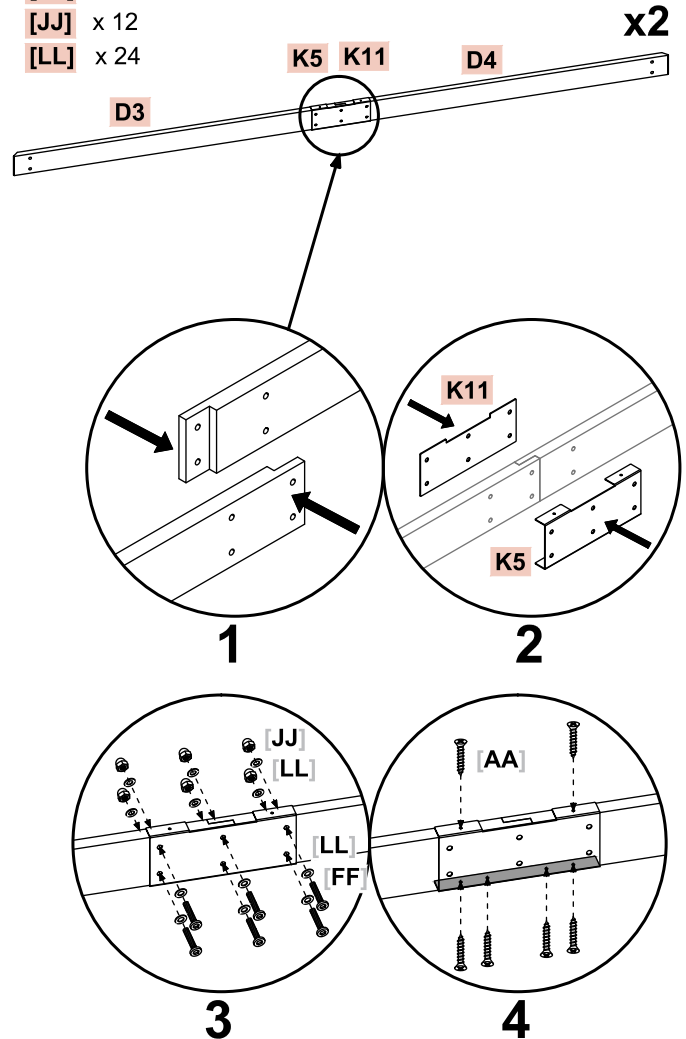

STEP 03

Attach cross beam **D15** and **D17** together using connector **K5** and **K11**. Secure with six (6) **[FF]** bolts, twelve (12) **[LL]** flat washers and six (6) **[JJ]** ball nuts on the sides. Use six (6) **[AA]** bolts secure both the top and bottom of the connection. Repeat to make a second assembly.

Repeat to make another two assemblies with cross beam **D16** and **D18**.

- [AA]** x 24
- [FF]** x 24
- [JJ]** x 24
- [LL]** x 48

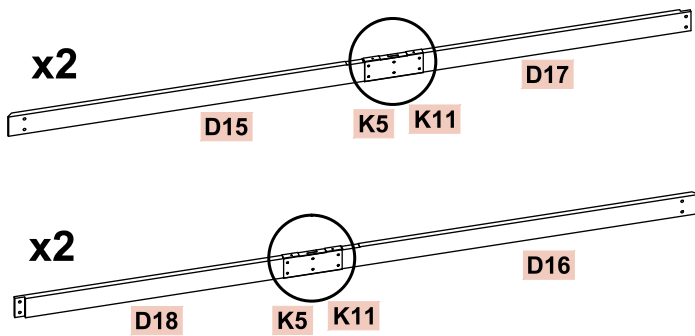
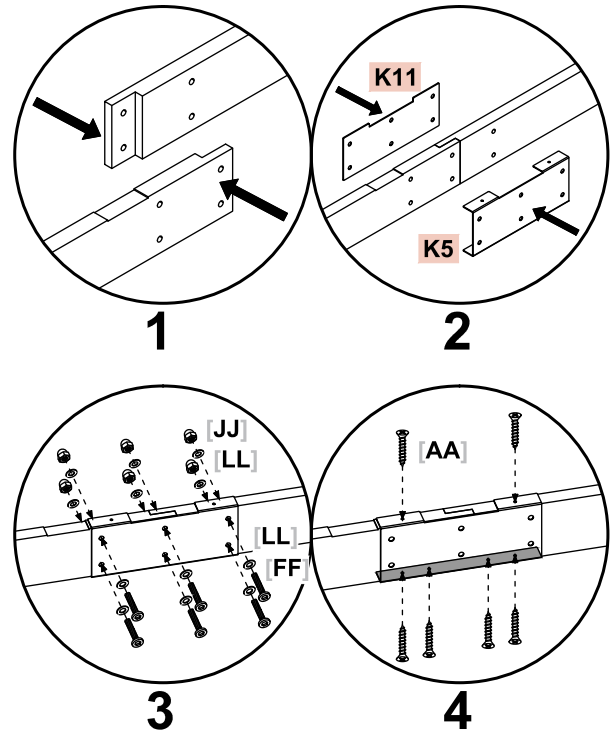

STEP 04

Attach the cross beam assembly **D3 D4** to left **A1** post using one (1) **[CC]** bolt and **[MM]** washer in the top hole, and one (1) **[GG]** bolt, two (2) **[MM]** washers, and one (1) **[HH]** nut in the bottom hole. Attach the cross beam assembly to right **A1** post, using one (1) **[GG]** bolt, two (2) **[MM]** washers, and one (1) **[HH]** nut in the top hole, and one (1) **[CC]** bolt and **[MM]** washer in the bottom hole. Repeat to make a second assembly.

- [CC]** x4
- [MM]** x12
- [HH]** x4
- [GG]** x4

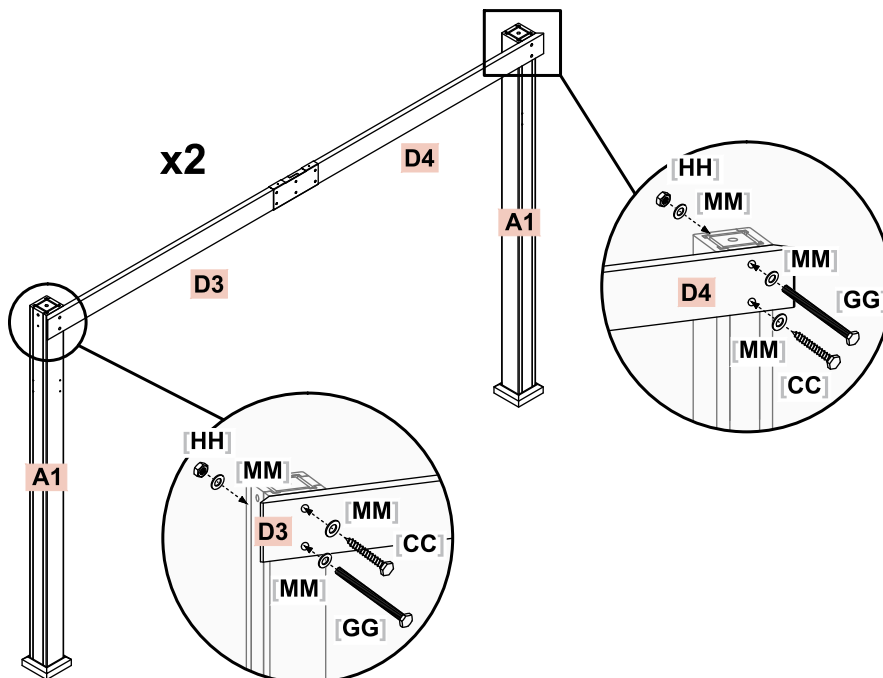

STEP 05

Attach the cross beam assembly **D15 D17** to left **A1** post using one (1) **[CC]** bolt and **[MM]** washer in the top hole, and one (1) **[GG]** bolt, two (2) **[MM]** washers, and one (1) **[HH]** nut in the bottom hole. Attach the cross beam assembly to **A2** post with connector **K8** and one end of cross beam **D18**, using one (1) **[CC]** bolt and **[MM]** washer in the top hole, and one (1) **[GG]** bolt, two (2) **[MM]** washers, and one (1) **[HH]** nut in the bottom hole.

Attach the cross beam assembly **D18 D16** to right **A1** post using one (1) **[GG]** bolt, two (2) **[MM]** washers, and one (1) **[HH]** nut in the top hole, and one (1) **[CC]** bolt and **[MM]** washer in the bottom hole.

Repeat with the other assembly set.

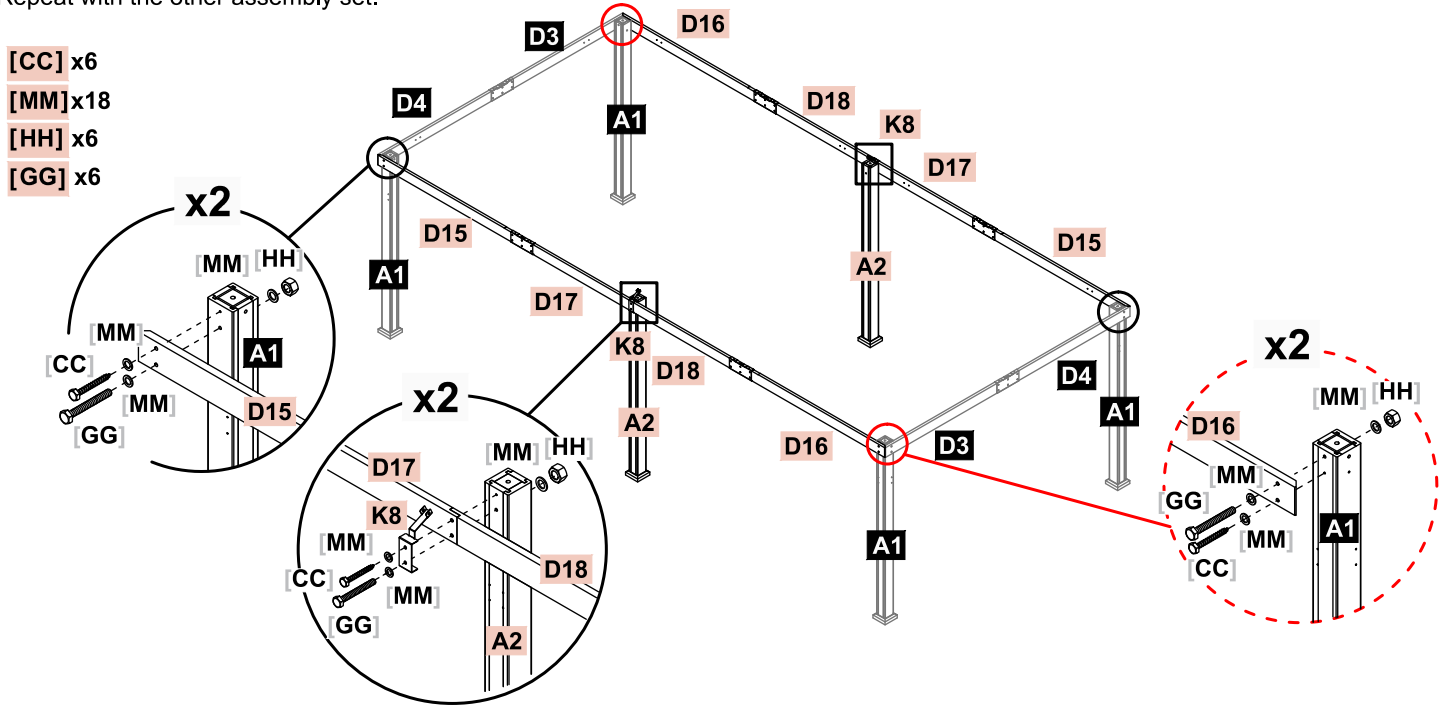

STEP 06 CRITICAL: SQUARE UNIT BEFORE PROCEEDING TO NEXT STEPS. ONCE SQUARE, TIGHTEN ALL HARDWARE.

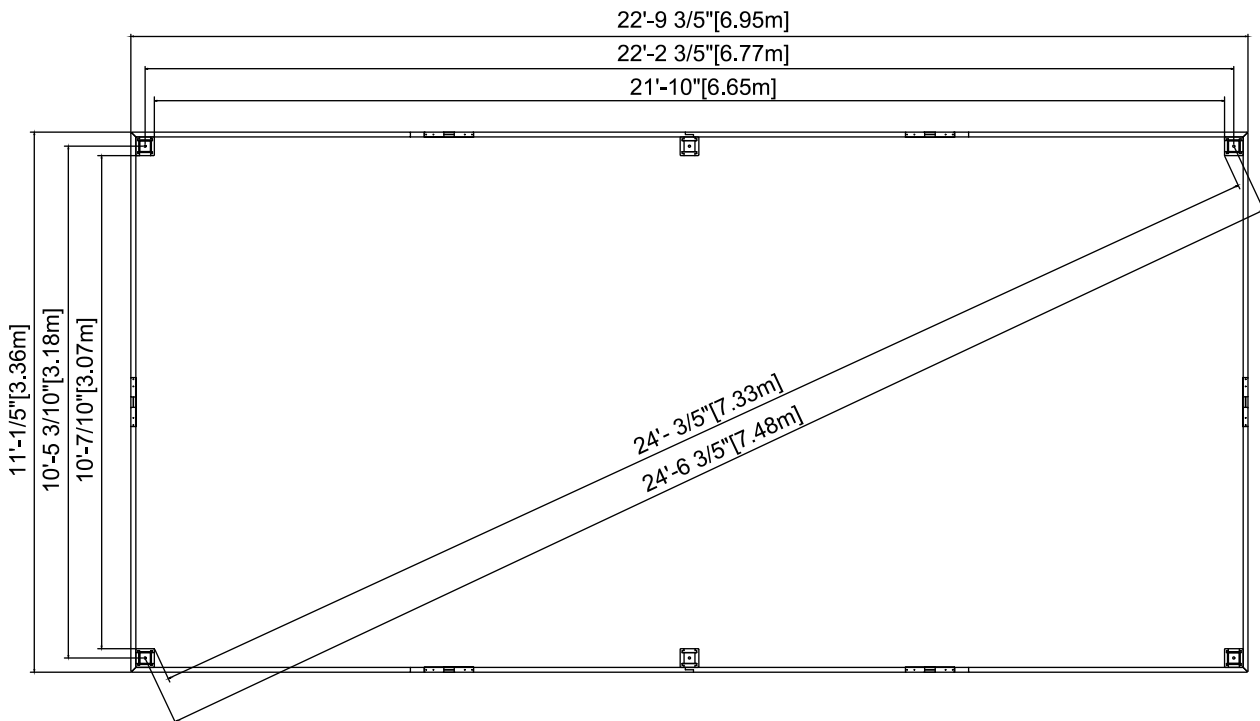

STEP 07

Use four (4) **[BB]** bolts and four (4) **[LL]** flat washers to attach one (1) support bracket **E1** to cross beam and post on left corner of each side. Repeat with the other five (5) support brackets **E1**.
 Use four (4) **[BB]** bolts and four (4) **[LL]** flat washers to attach one (1) support bracket **E2** to cross beam and post on right corner of each side. Repeat with the other five (5) support brackets **E2**.

[BB] x48

[LL] x48

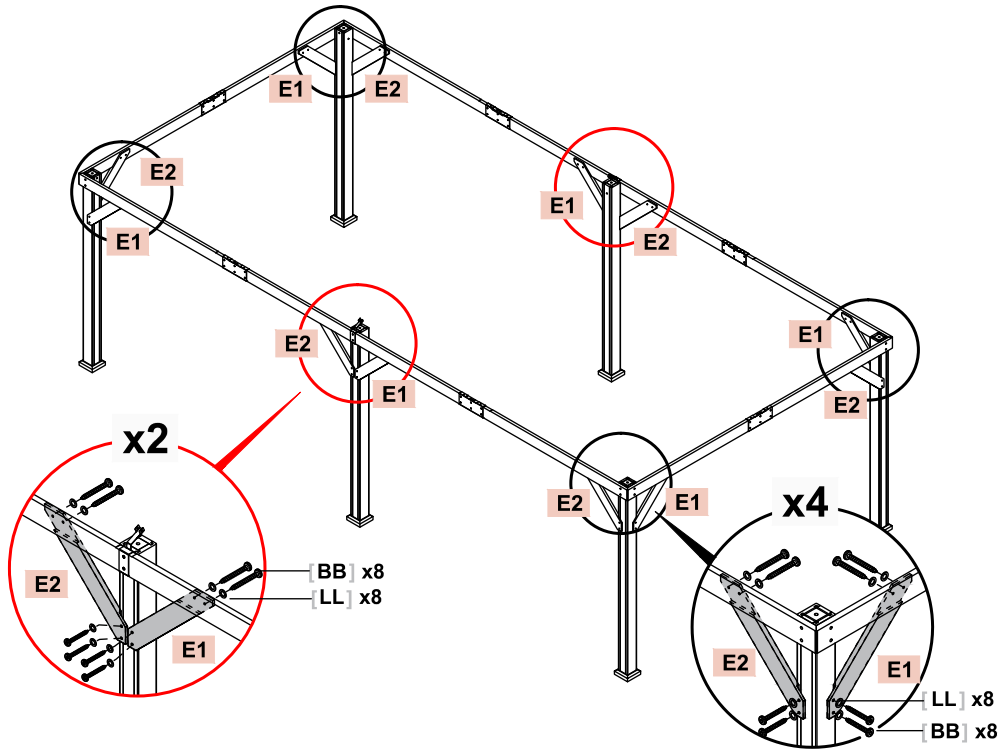

STEP 08

Use eight (8) **[AA]** bolts to attach one (1) connector **K2** to each corner.

[AA] x32

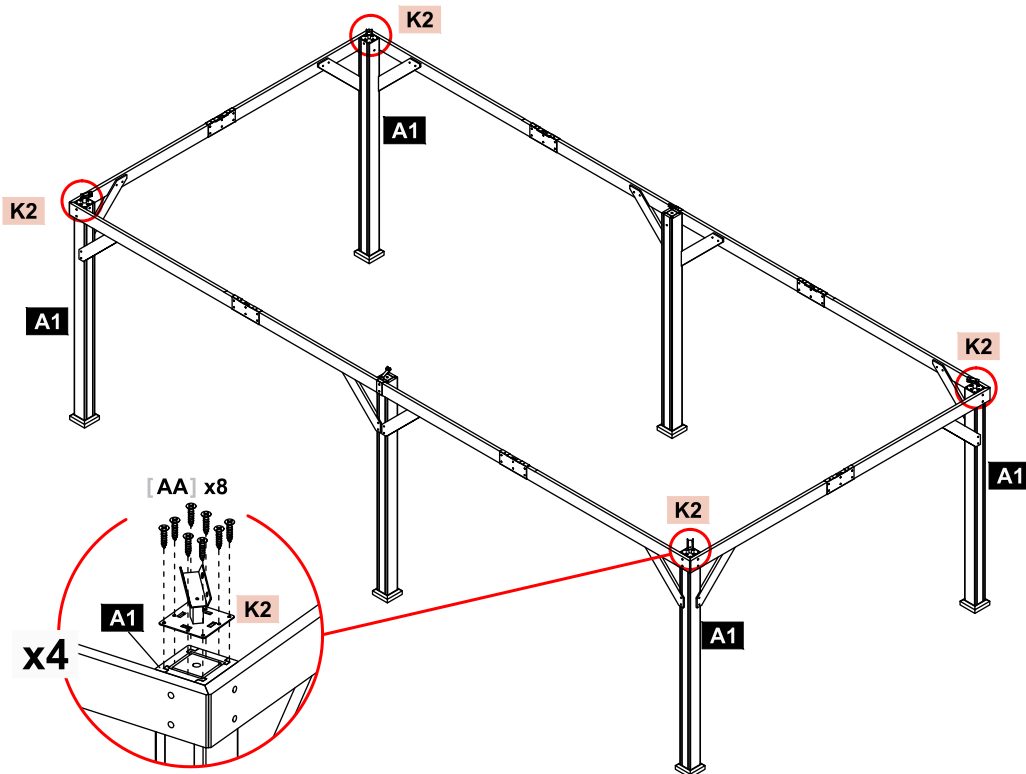

STEP 09

Slide roof rib **F4** onto **F5**. Securing with two (2) **[VV]** bolts and two (2) **[KK]** flat washers. Use one (1) **[DD]** bolt and one (1) **[KK]** flat washer to attach each connector **K4** to roof rib **F4** **F5**. Repeat with the other two (2) **K4** on one roof rib assembly. Repeat with the other three (3) roof rib assembly.

- [DD]** x12
- [KK]** x20
- [VV]** x8

Make sure the connectors face upward as shown.

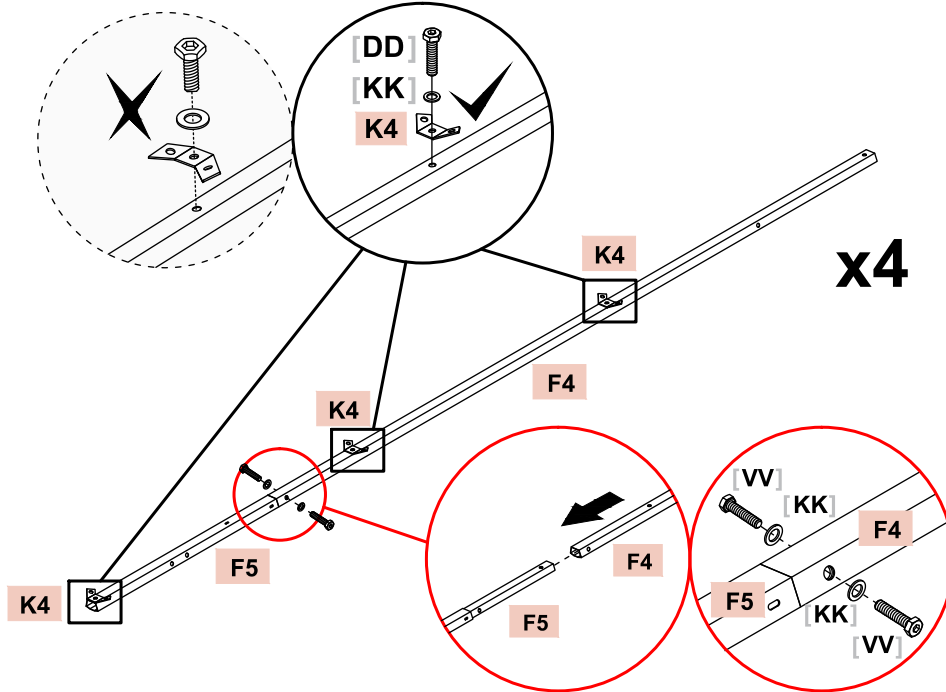

STEP 10

Slide two (2) connector **K21** onto connector **K22**, then attach hook **N** to the assembly. Secure with twelve (12) **[DD]** bolts and twelve (12) **[KK]** flat washers on the sides, and six (6) **[DD]** bolts and six (6) **[KK]** flat washers on the bottom.

- [DD]** x18
- [KK]** x18

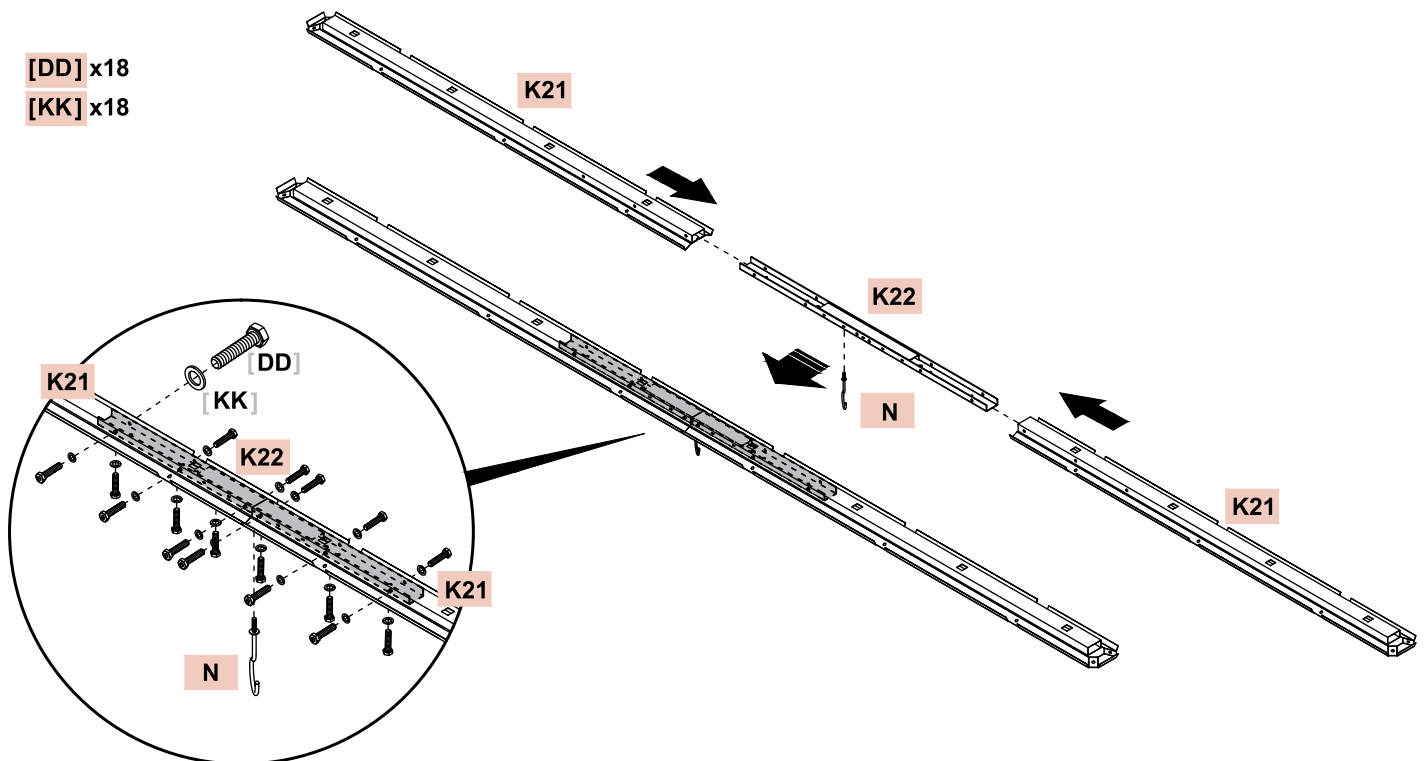

STEP 11

Use four (4) [DD] bolts and four (4) [KK] flat washers to attach connector **K21** to roof ribs **F4**. Use two (2) [DD] bolts and two (2) [KK] flat washers to attach each roof rib **F5** to connector **K2** on the posts.

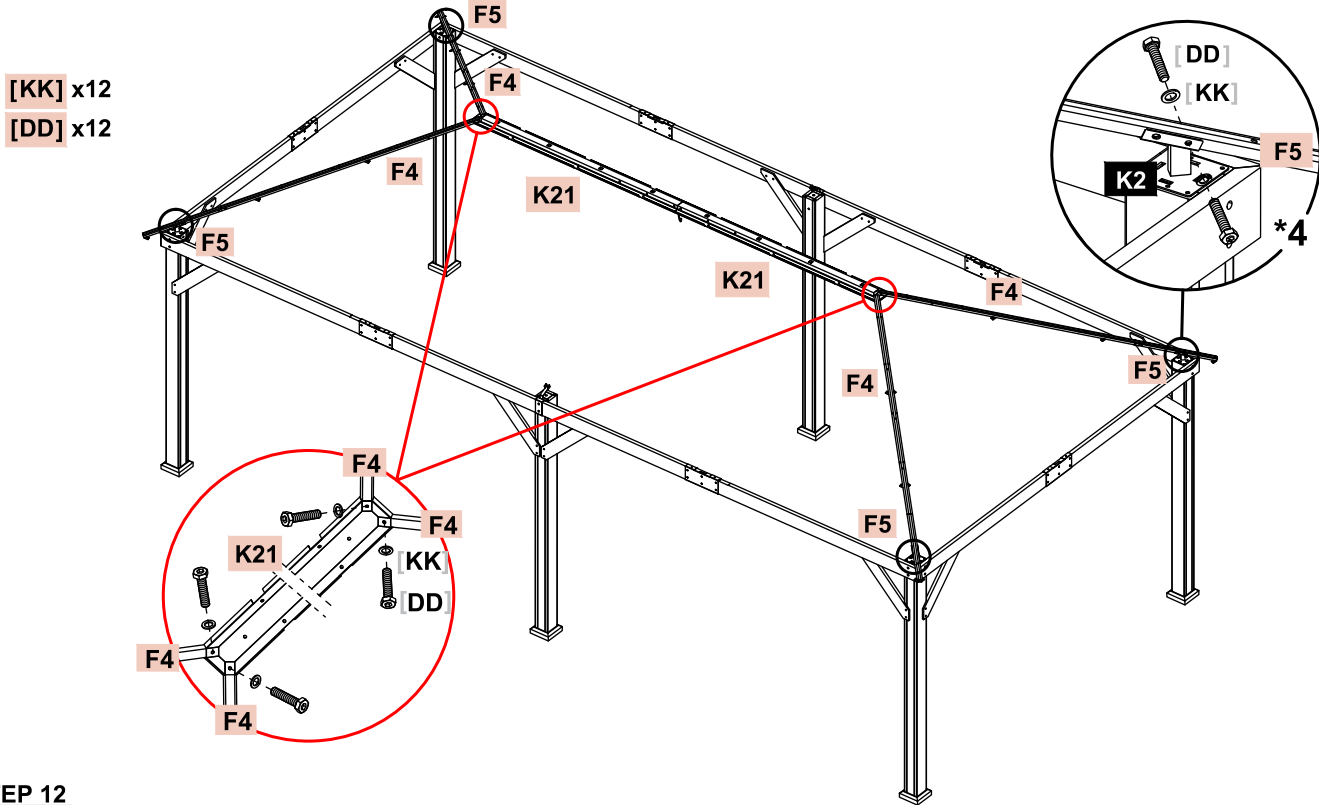

STEP 12

Use one (1) [VV] bolt, one (1) [DD] bolt and two (2) [KK] flat washers to attach one (1) mosquito net rod **M1** to connector **K6** and connector **K2** with roof rib **F5**. Repeat with the other **M1** and two (2) **M2**.
Use one (1) [VV] bolt, one (1) [DD] bolt and two (2) [KK] flat washers to attach one (1) mosquito net rod **M4** to connector **K26** on the cross beams and connector **K2** with roof rib **F5**. Repeat with the other **M4** and two (2) **M3**.
Use two (2) [VV] bolts and two (2) [KK] flat washers to attach one (1) mosquito net rod **M5** to connector **K8** and **K6** on the cross beams. Repeat with the other three (3) **M5**.

- [KK] x24
- [DD] x8
- [VV] x16

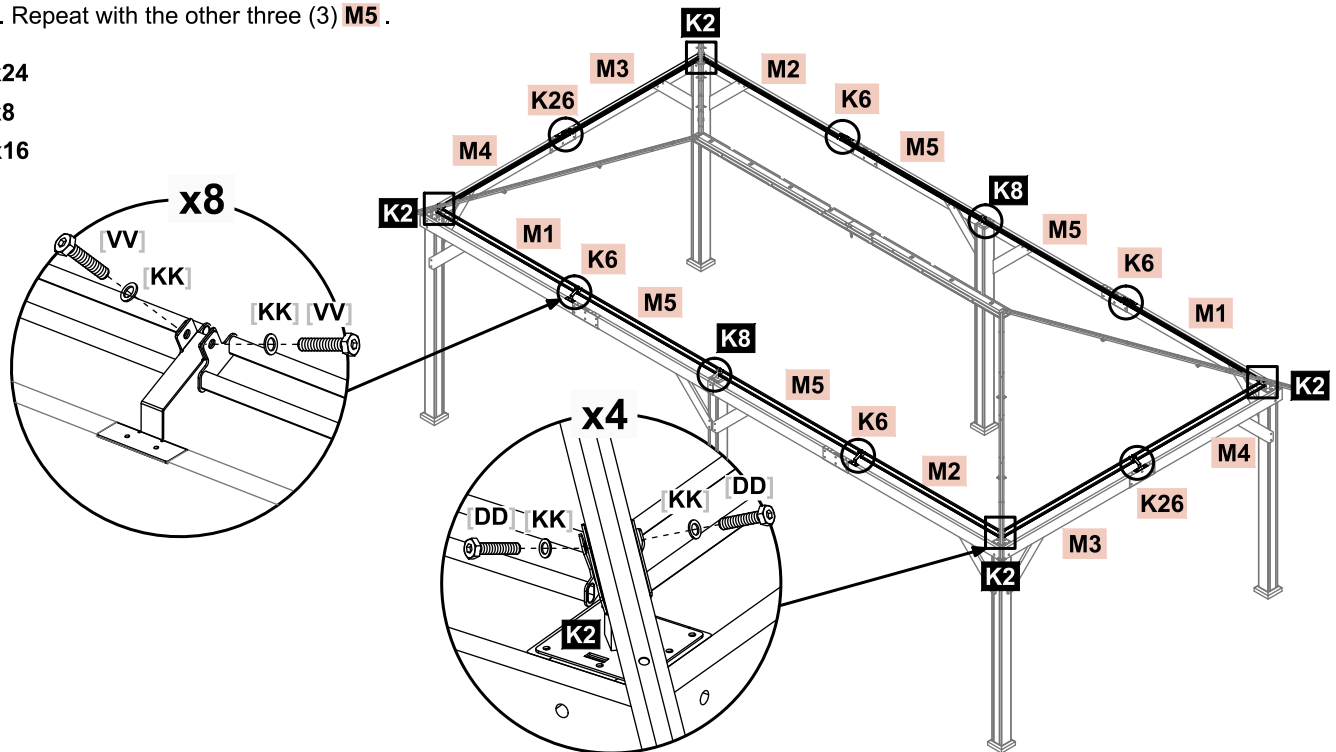

STEP 13

Use four (4) [AA] bolts to attach each connector **K26** to cross beams **D3** **D4** . Repeat with the other **K26** .
 Use four (4) [AA] bolts to attach each connector **K6** to cross beams **D15** **D16** . Repeat with the other three (3) **K6** .

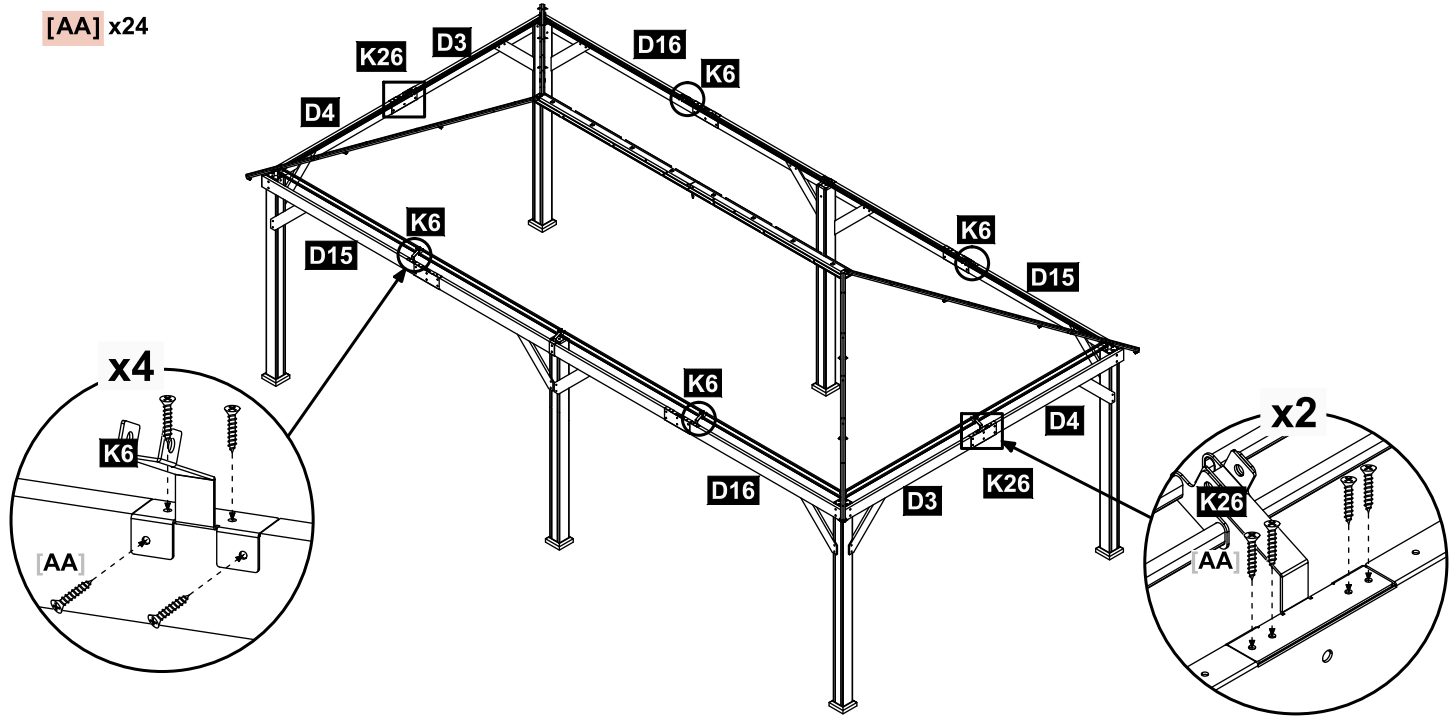

STEP 14

Use two (2) [DD] bolts and two (2) [KK] flat washers to attach one (1) connector **K1** to roof rib **G4** . Repeat with the other eleven (11) **G4** and **K1** .

[KK] x24

[DD] x24

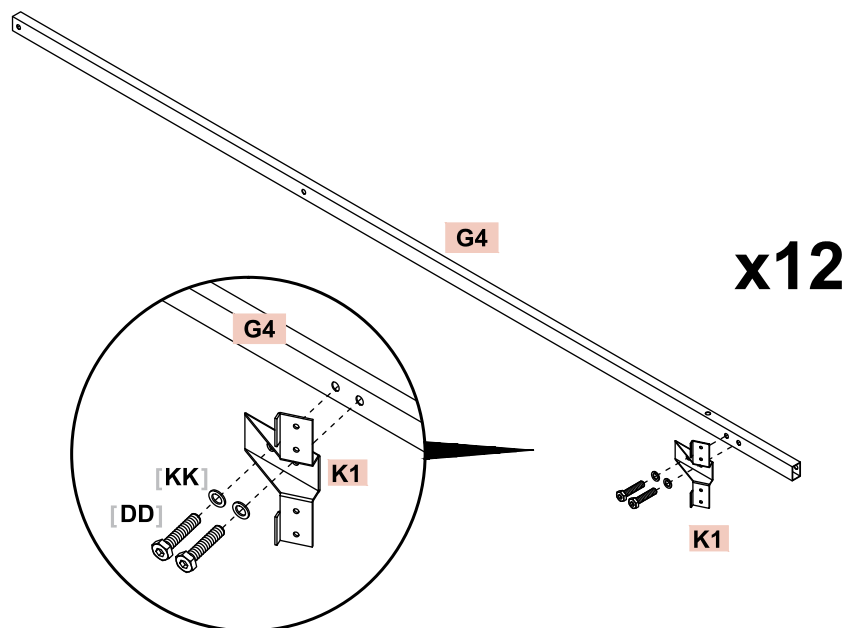

STEP 15

Attach connector **K1** on roof rib **G4** to cross beams. Use one (1) **[DD]** bolt and one (1) **[KK]** flat washer to attach the upper end of roof rib **G4** to connector **K21**. Repeat with the other eleven (11) **G4**.

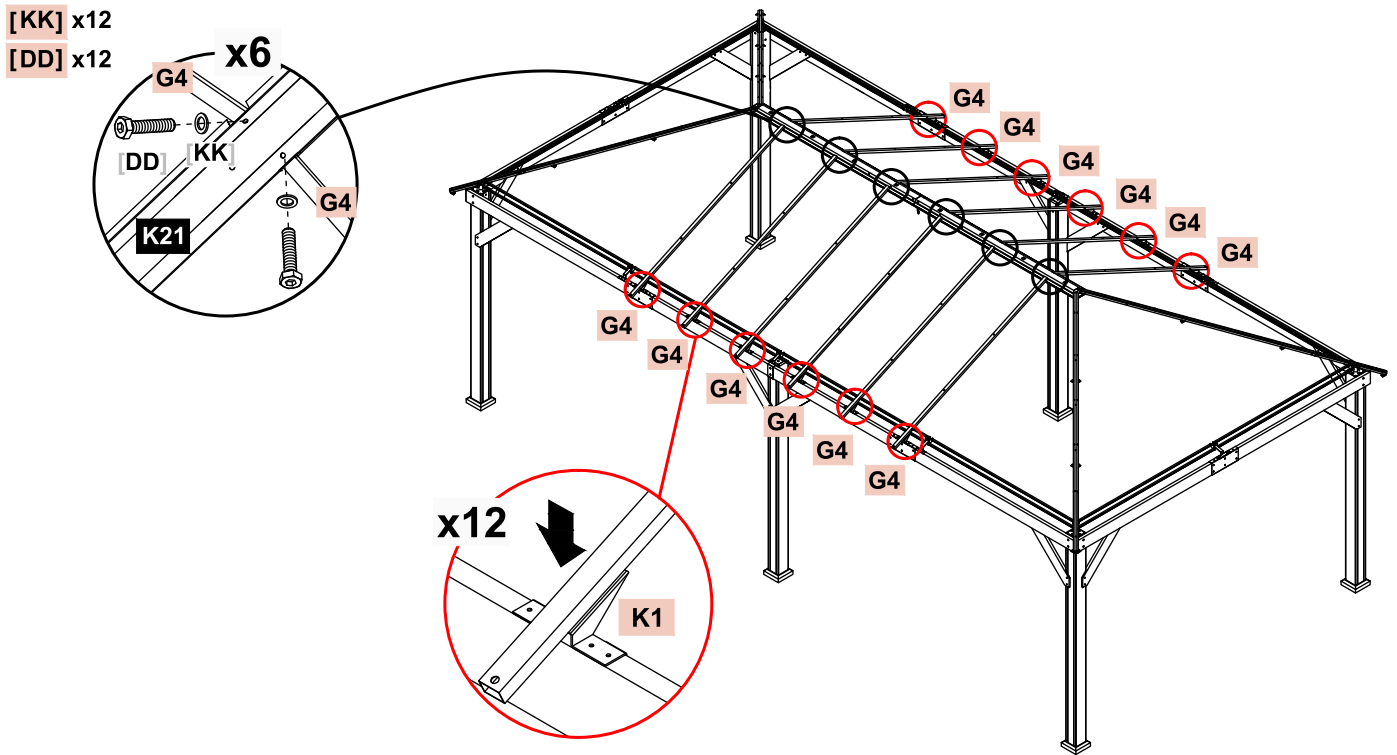

STEP 16

Use two (2) **[DD]** bolts and two (2) **[KK]** flat washers to attach one (1) connector **K1** to middle cross beam **G5**. Repeat to make the other three (3) assemblies.

Use two (2) **[DD]** bolts and two (2) **[KK]** flat washers to attach one (1) connector **K1** to middle cross beam **G6**. Repeat to make the other three (3) assemblies.

- [KK]** x16
- [DD]** x16

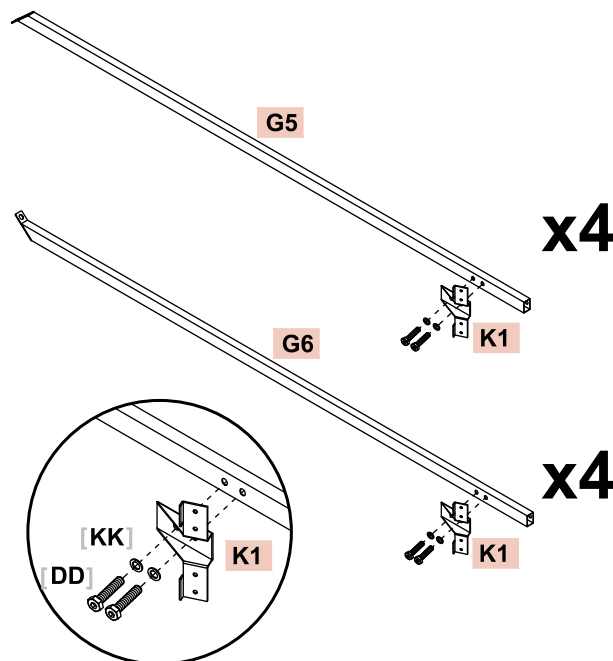

STEP 17

Attach connector **K1** to cross beams. Use one (1) **[VV]** bolt and one (1) **[KK]** flat washer to attach the upper end of **G5** to roof rib **F4**. Repeat with the other three (3) **G5** and four (4) **G6**.

[KK] x8
[VV] x8

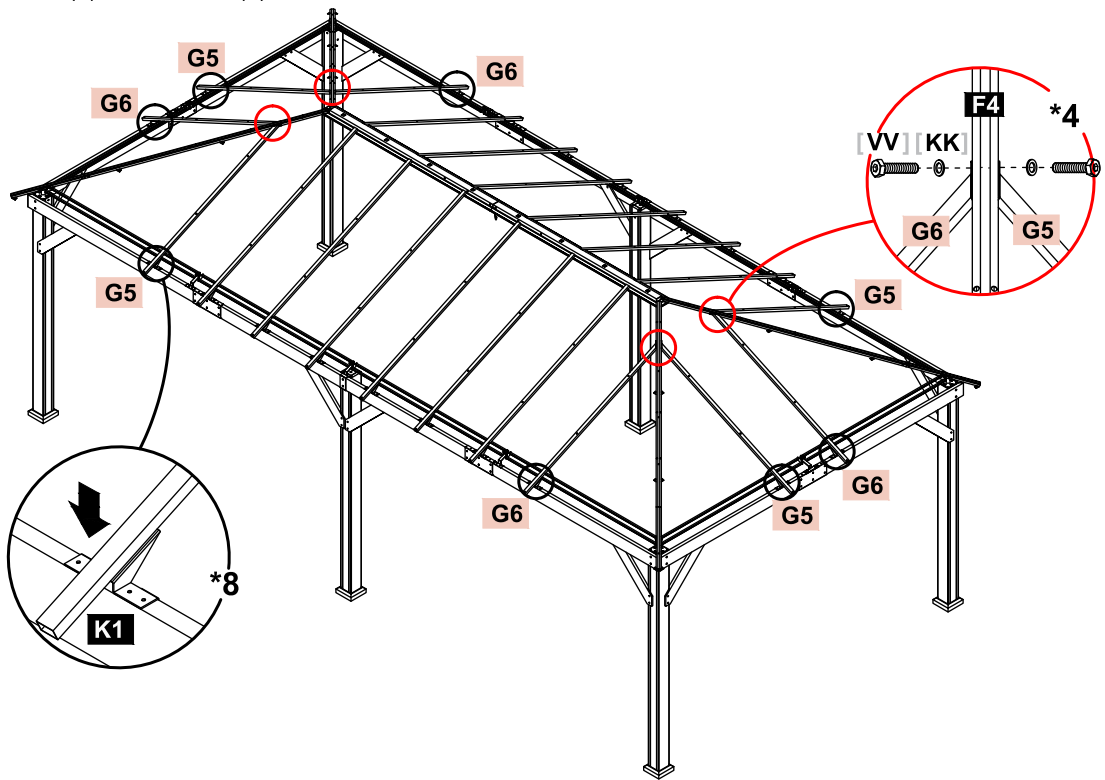

STEP 18

Create a roof support assembly by sliding the parts together in this order: **K3**, **H1**, **K3**, **H1**, and **K3**, securing with **[VV]** bolts and **[KK]** flat washers. Repeat with a second assembly. Create a second assembly in this order: **H1**, **K3**, **H1**, **K3**, **H1** and **K3**, securing with **[VV]** bolts and **[KK]** flat washers. Repeat with a second assembly. Create a third assembly in this order: **H1**, **K3**, **H1** and **K3**, securing with **[VV]** bolts and **[KK]** flat washers. Repeat with a second assembly.

[KK] x24
[VV] x24

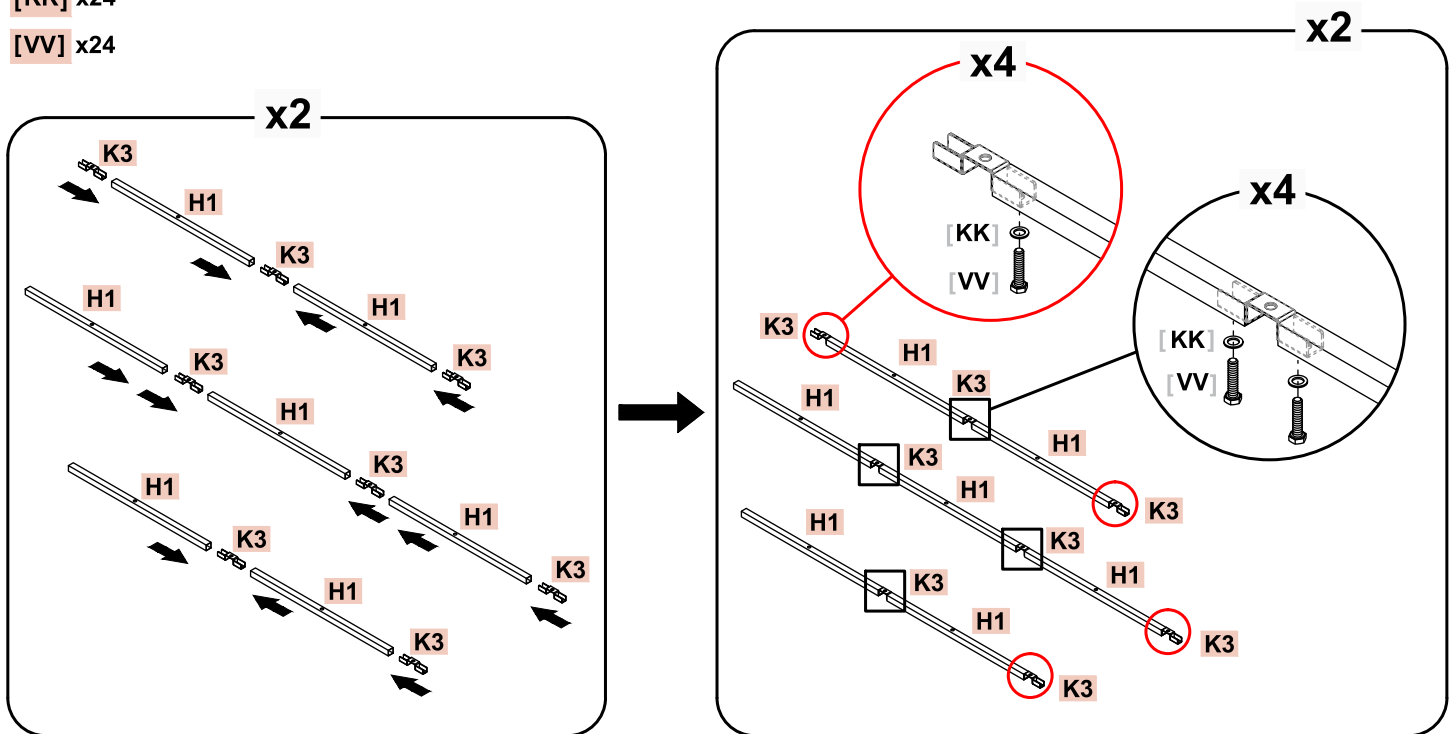

STEP 19

Create a roof support assembly by sliding the parts together in this order: **K3**, **H1**, and **K3**, securing with **[VV]** bolts and **[KK]** flat washers. Repeat with a second assembly.

[KK] x4

[VV] x4

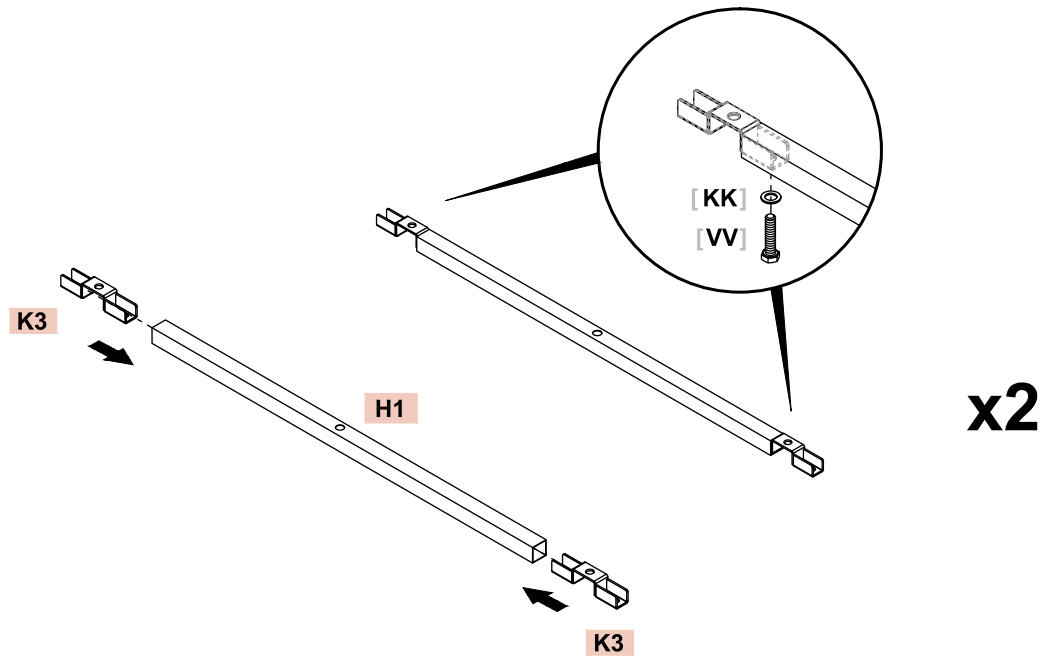

STEP 20

Use three (3) **[YY]** double-headed screws to attach one (1) assembly **K3**, **H1**, **K3**, **H1**, **K3** to middle cross beam **G4** and **G5**. Repeat with the other assembly.

Use two (2) **[YY]** double-headed screws to attach one (1) assembly **K3**, **H1**, **K3** to middle cross beam **G5** and **G6**. Repeat with the other assembly.

[YY] x10

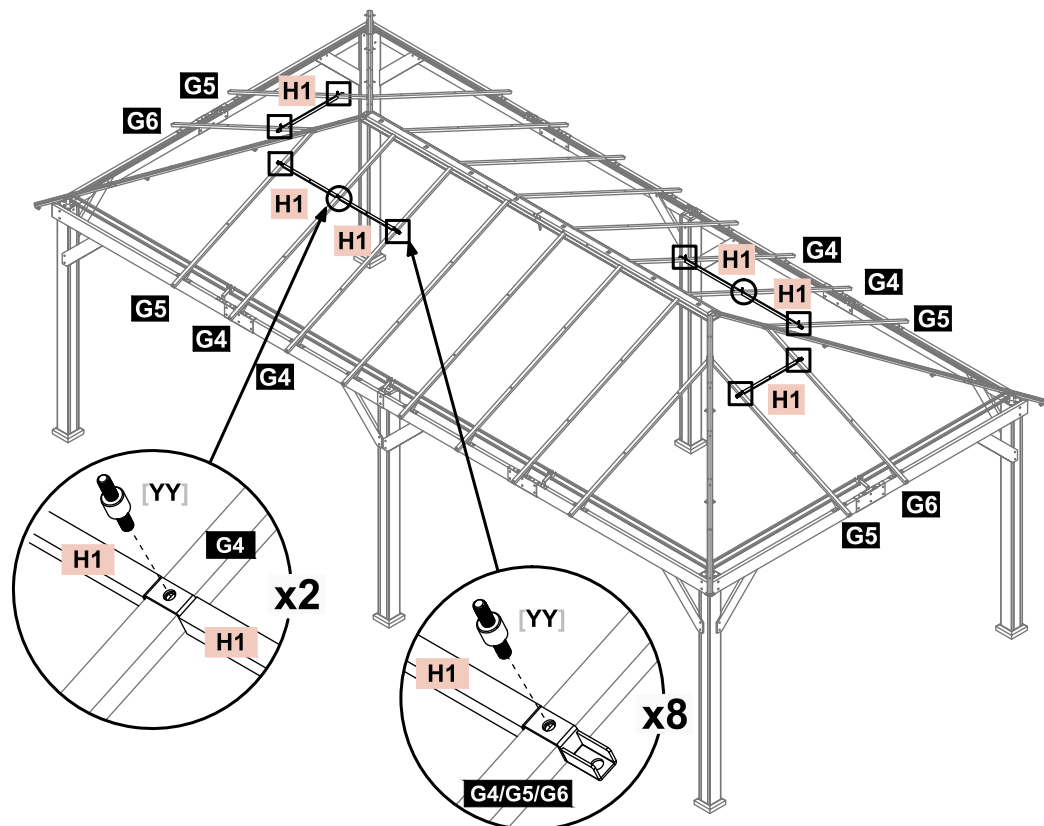

STEP 21

Slide roof support **H1** on one end of assembly onto Connector **K3**, securing with **[VV]** bolt and **[KK]** flat washer. Use three (3) **[YY]** double-headed screws to attach one (1) assembly **H1, K3, H1, K3, H1, K3** to middle cross beams **G4**. Repeat with the other assembly.

[KK] x2

[VV] x2

[YY] x6

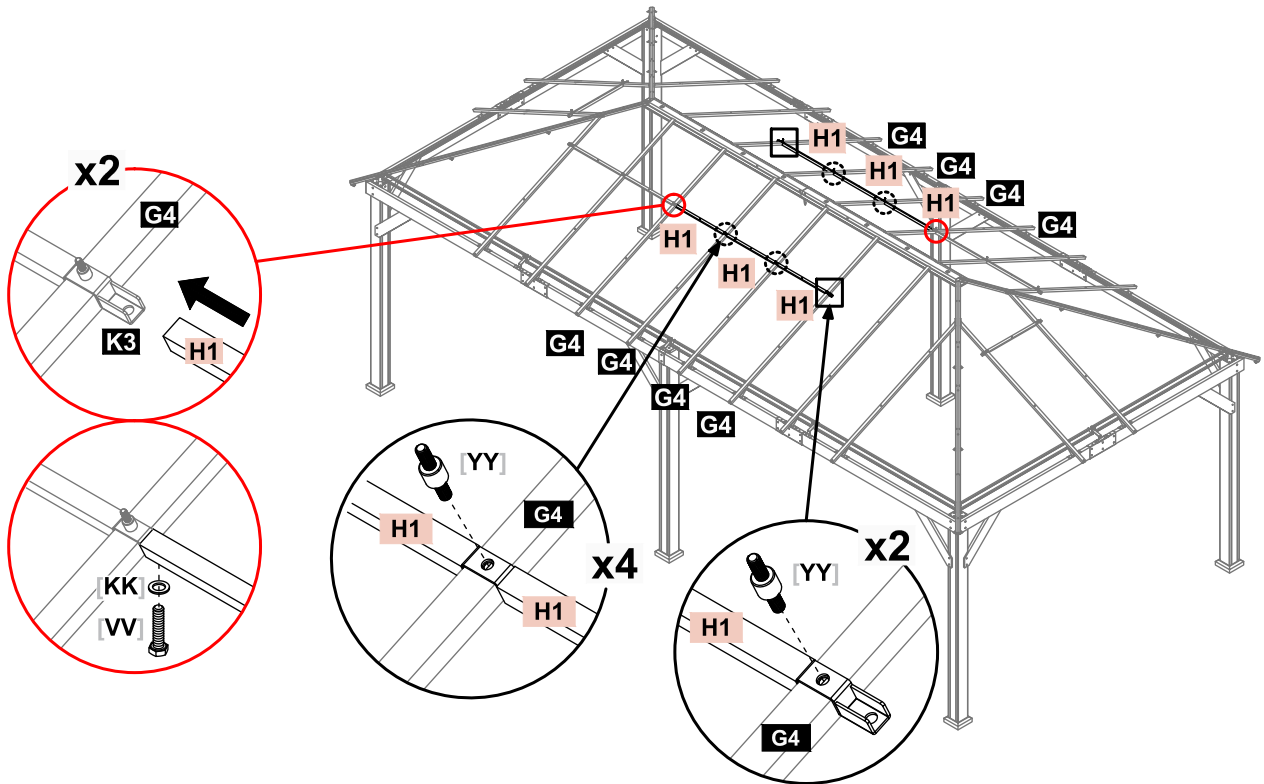

STEP 22

Slide roof support **H1** on one end of assembly onto Connector **K3**, securing with **[VV]** bolt and **[KK]** flat washer. Use two (2) **[YY]** double-headed screws to attach one (1) assembly **H1, K3, H1, K3** to middle cross beams **G4** and **G6**. Repeat with the other assembly.

[KK] x2

[VV] x2

[YY] x4

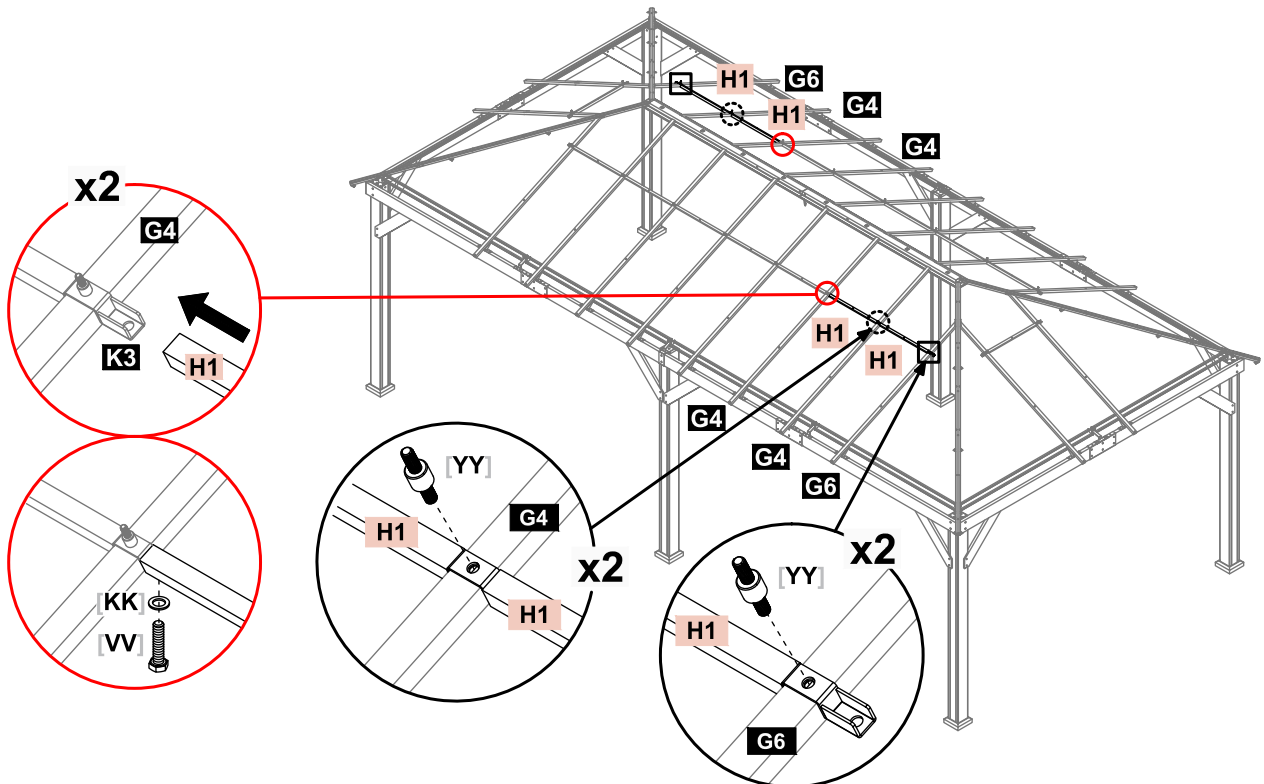

STEP 23

Create a roof support assembly by sliding the parts together in this order: **K3**, **H3**, **K3**, **H3**, and **K3**, securing with **[VV]** bolts and **[KK]** flat washers. Repeat with a second assembly. Create a second assembly in this order: **H3**, **K3**, **H3**, **K3**, **H3** and **K3**, securing with **[VV]** bolts and **[KK]** flat washers. Repeat with a second assembly. Create a third assembly in this order: **H3**, **K3**, **H3** and **K3**, securing with **[VV]** bolts and **[KK]** flat washers. Repeat with a second assembly.

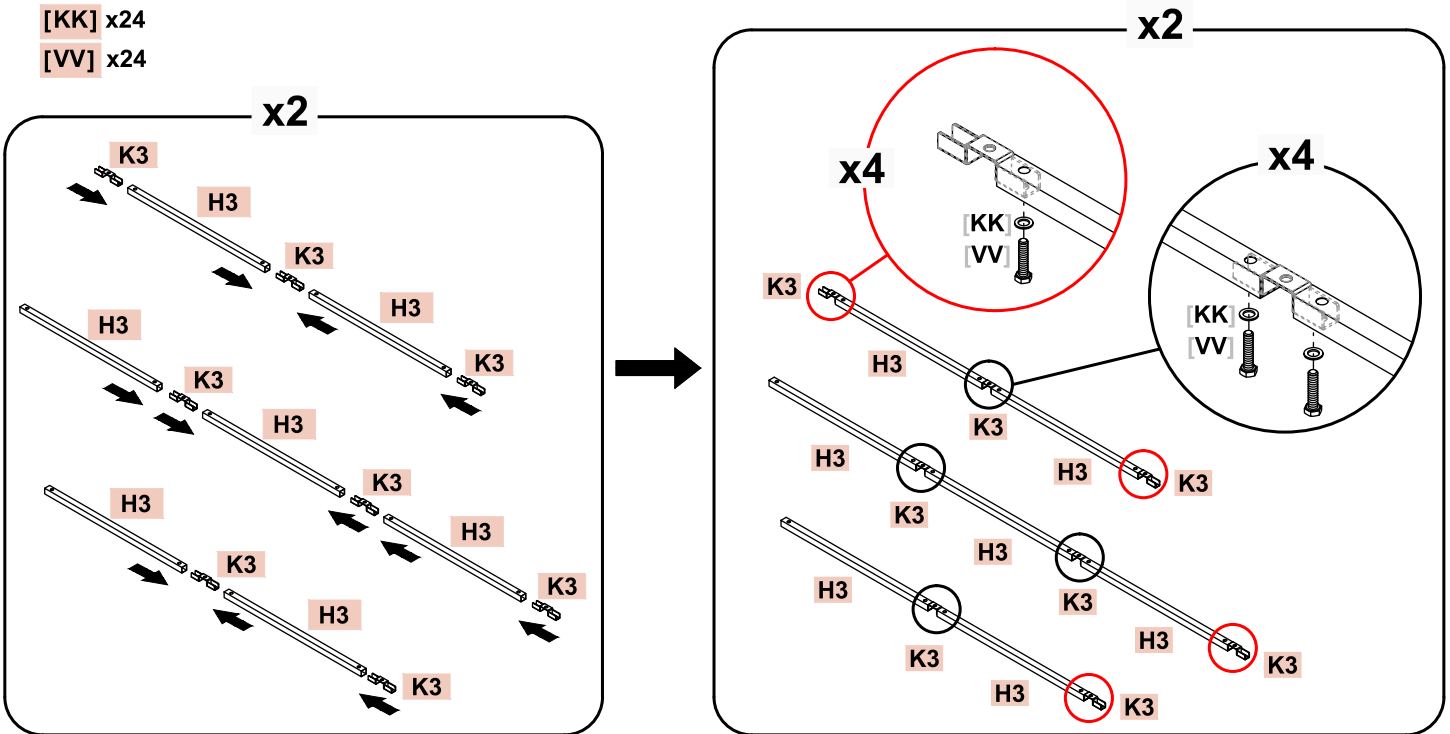

STEP 24

Create a roof support assembly by sliding the parts together in this order: **K3**, **H3** and **K3**. Secure using **[VV]** bolt and **[KK]** washer. Repeat the process to make a second assembly.

[KK] x4
[VV] x4

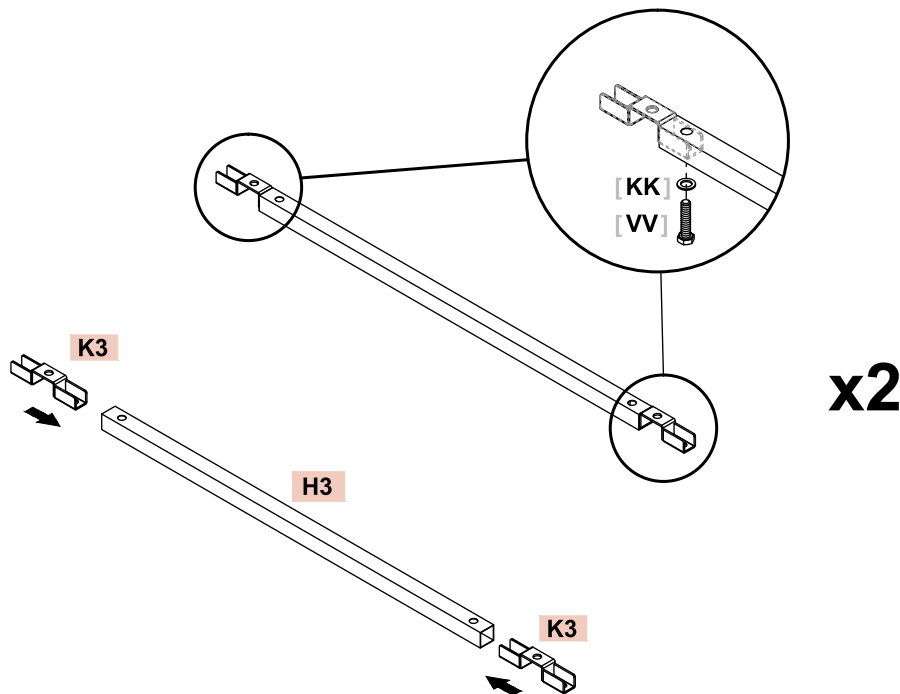

STEP 25

Use three (3) [DD] bolts and three (3) [KK] flat washers to attach one (1) assembly **K3**, **H3**, **K3**, **H3**, **K3** to middle cross beam **G4** and **G5**. Repeat with the other assembly.

Use two (2) [DD] bolts and two (2) [KK] flat washers to attach one (1) assembly **K3**, **H3**, **K3** to middle cross beam **G5** and **G6**. Repeat with the other assembly.

[KK] x10

[DD] x10

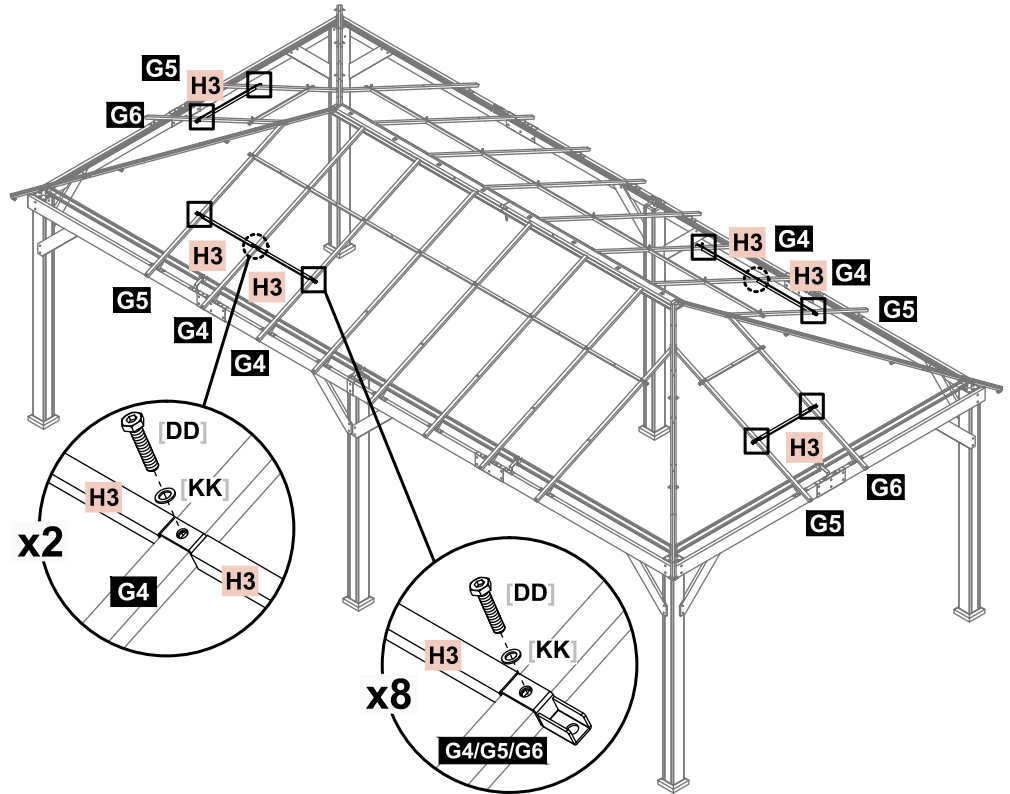

STEP 26

Slide roof support **H3** on one end of assembly onto Connector **K3**, securing with [VV] bolt and [KK] flat washer. Use three (3) [DD] bolts and three (3) [KK] flat washers to attach one (1) assembly **H3**, **K3**, **H3**, **K3**, **H3**, **K3** to middle cross beams **G4**. Repeat with the other assembly.

[VV] x2

[DD] x6

[KK] x8

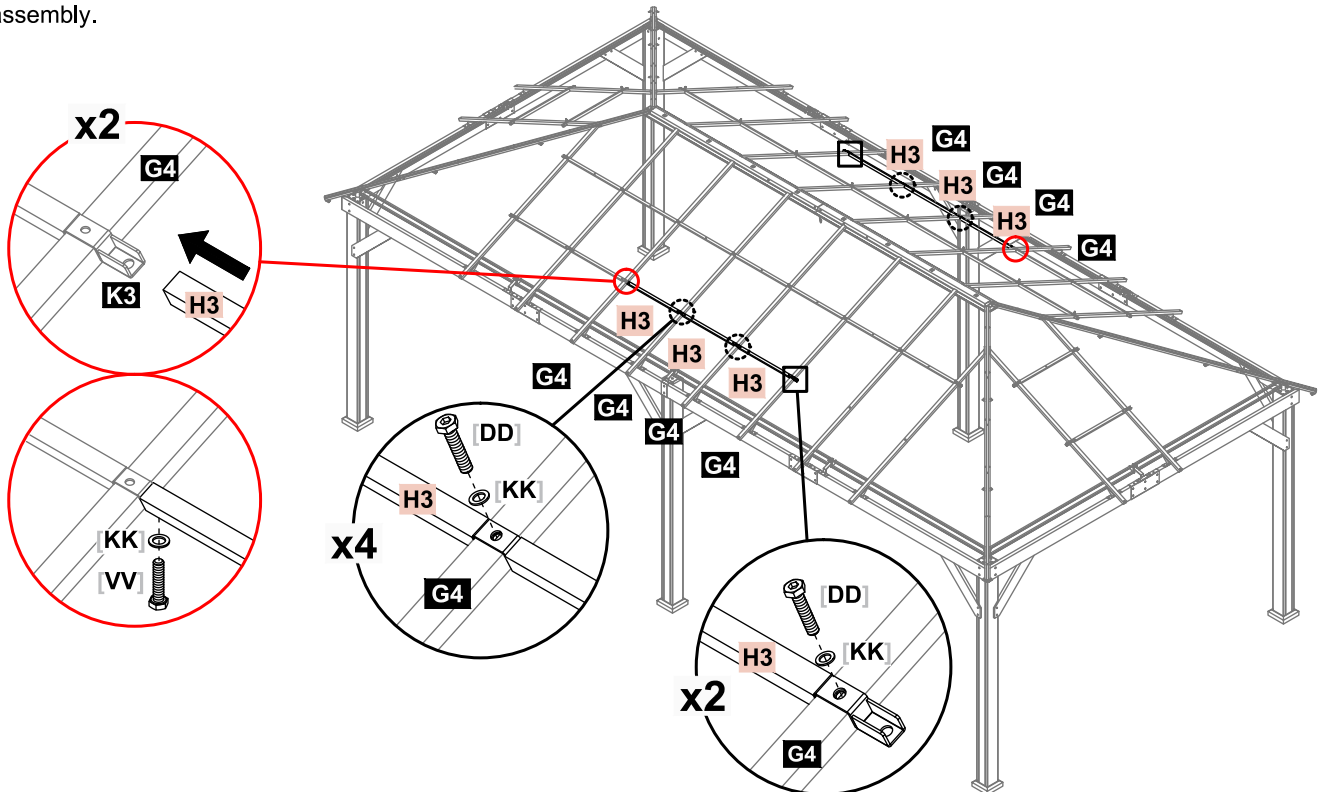

STEP 27

Slide roof support **H3** on one end of assembly onto Connector **K3**, securing with **[VV]** bolt and **[KK]** flat washer. Use two (2) **[DD]** bolts and two (2) **[KK]** flat washers to attach one (1) assembly **H3**, **K3**, **H3**, **K3** to middle cross beams **G4** and **G6**. Repeat with the other assembly.

[VV] x2

[DD] x4

[KK] x6

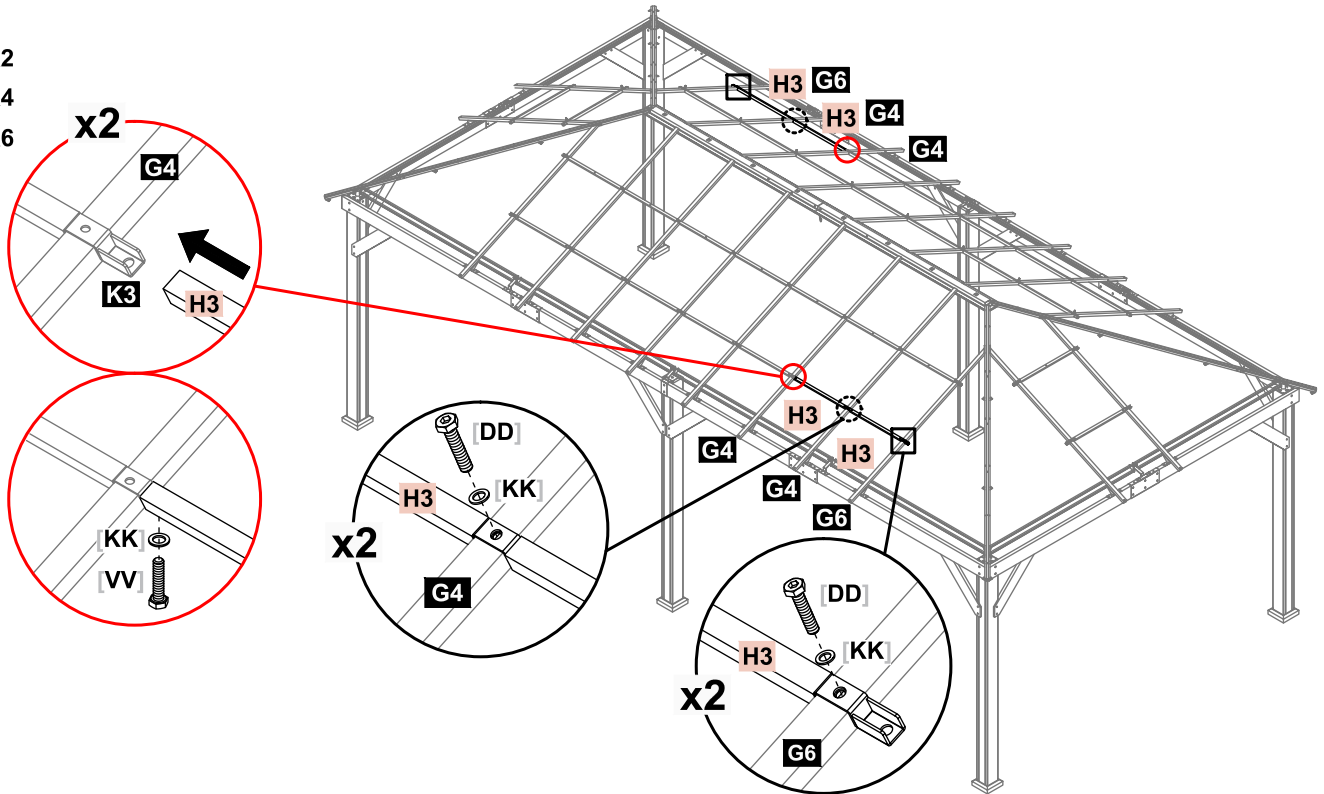

STEP 28

Slide roof support **H8** onto middle cross beam **G5 / G6**. Use two (2) **[VV]** bolts and two (2) **[KK]** flat washers to attach one (1) **H8** to **G5 / G6** and roof rib assembly **F4 F5**. Repeat with the other seven (7) **H8**.

Slide roof support **H2** onto middle cross beam **G5 / G6**. Use two (2) **[VV]** bolts and two (2) **[KK]** flat washers to attach one (1) **H2** to **G5 / G6** and roof rib assembly **F4 F5**. Repeat with the other seven (7) **H2**.

[KK] x32

[VV] x32

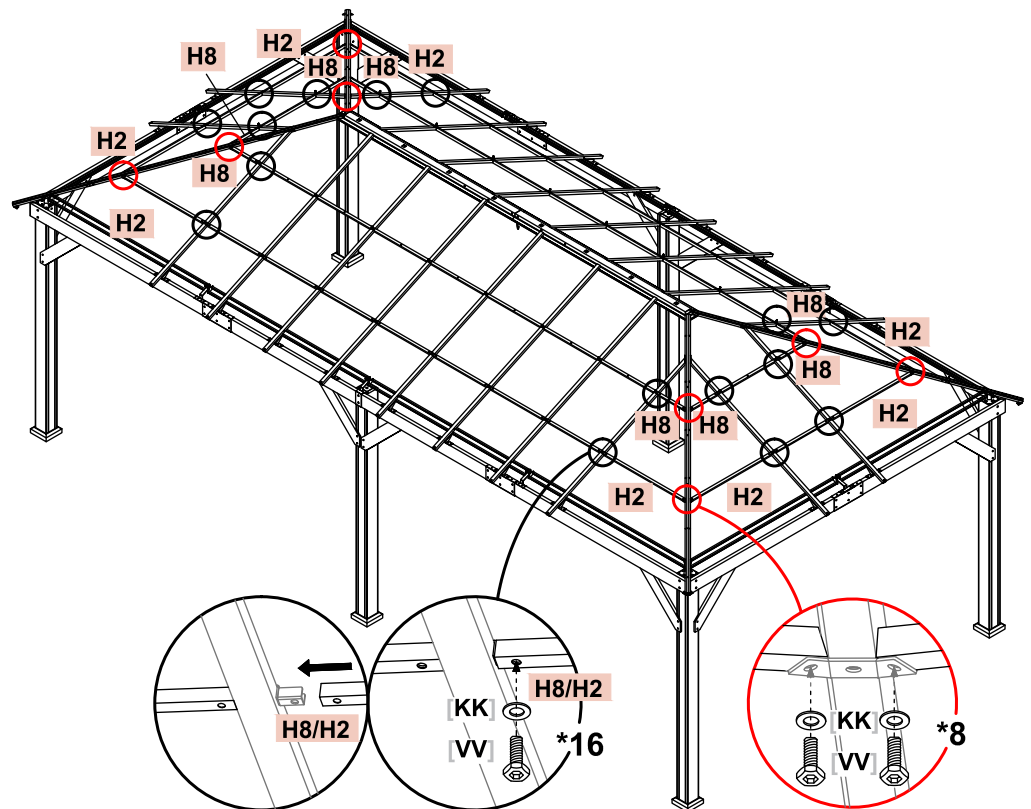

STEP 29

Create a roof border assembly by sliding the parts together in this order: **K3** , **J3** , **K3** , **J3** , and **K3** . Repeat with a second assembly. Create a second assembly in this order: **K3** , **J3** , **K3** , **J3** , **K3** and **J3** . Repeat with a second assembly. Create a third assembly in this order: **K3** , **J3** , **K3** and **J3** . Repeat with a second assembly.

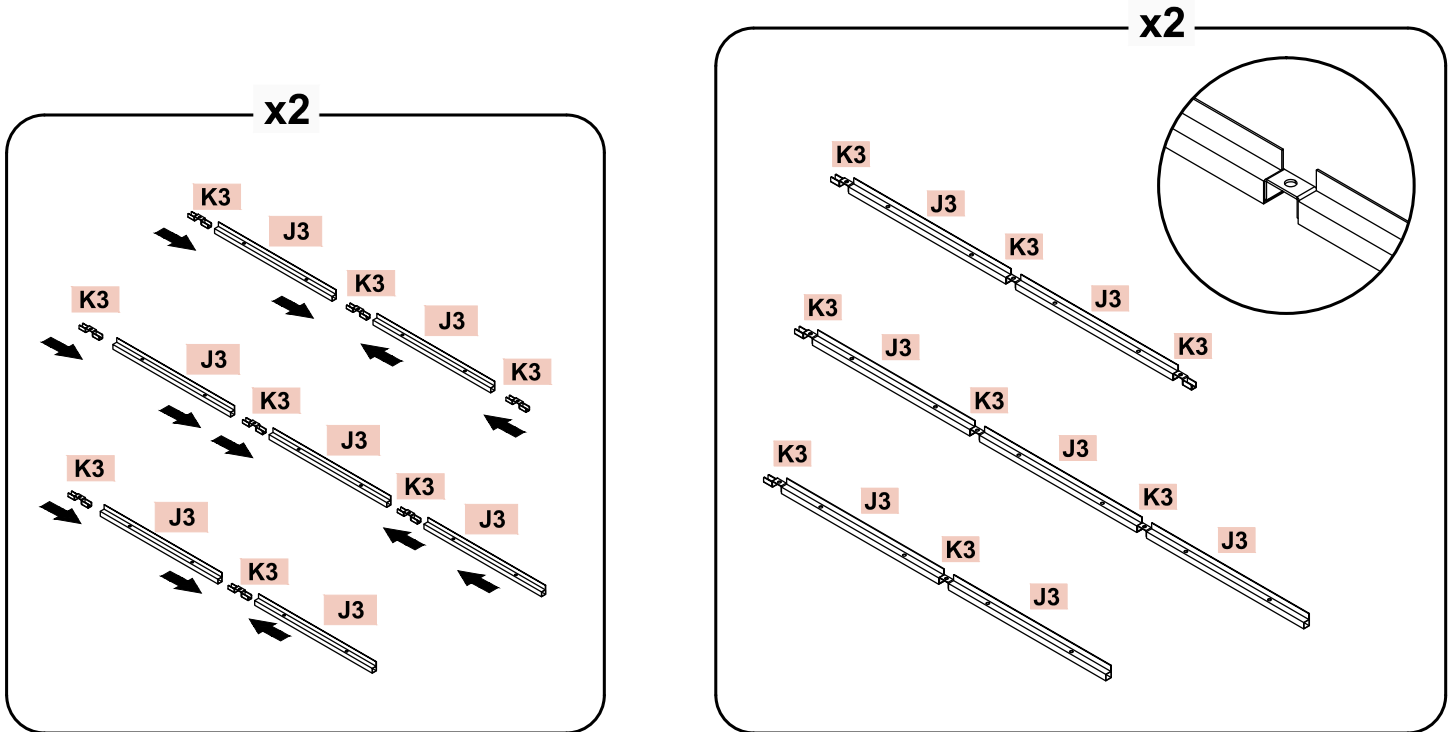

STEP 30

Create a roof border assembly by sliding the parts together in this order: **K3** , **J3** and **K3** . Repeat the process to make a second assembly

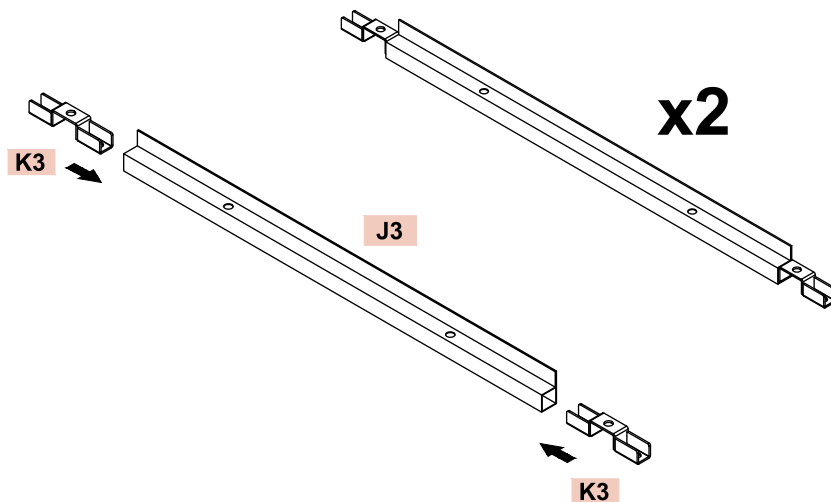

STEP 31

Use three (3) [DD] bolts and three (3) [KK] flat washers to attach one (1) assembly **K3**, **J3**, **K3**, **J3**, **K3** to middle cross beam **G4** and **G5**. Repeat with the other assembly.

Use two (2) [DD] bolts and two (2) [KK] flat washers to attach one (1) assembly **K3**, **J3**, **K3** to middle cross beam **G5** and **G6**. Repeat with the other assembly.

[KK] x10
[DD] x10

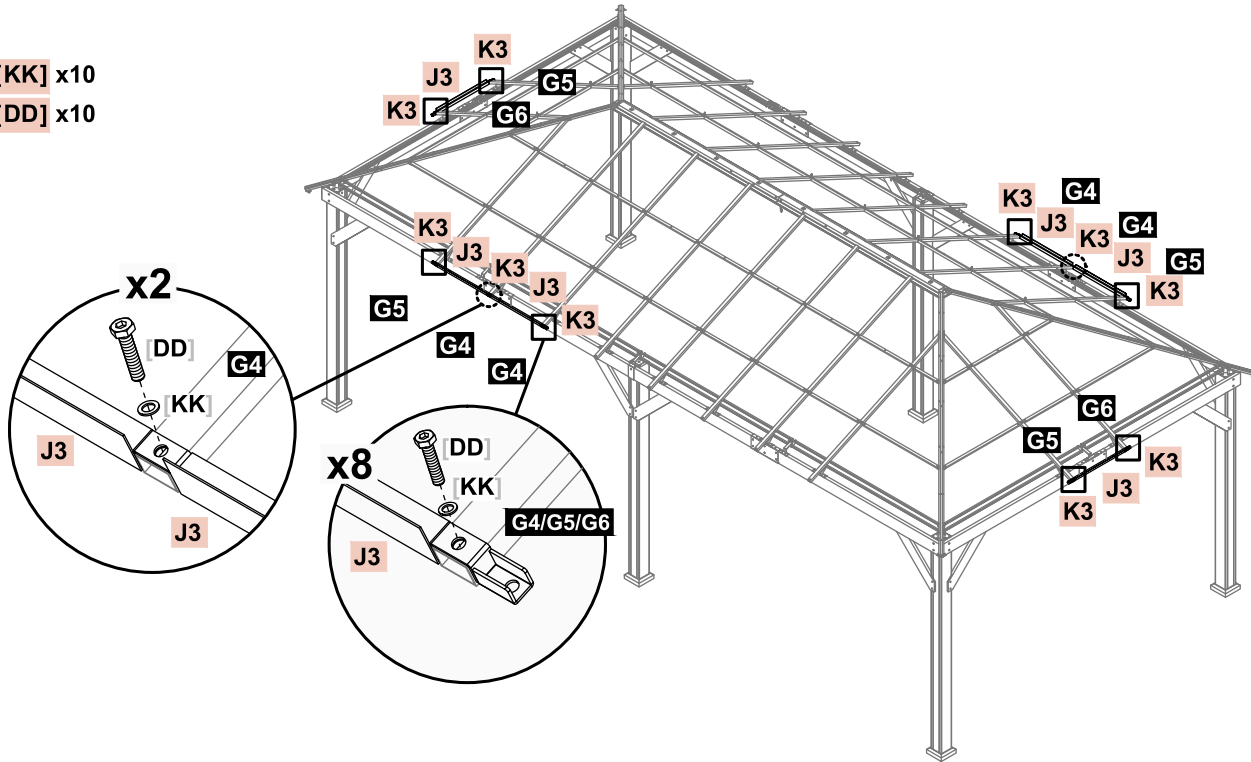

STEP 32

Slide roof border **J3** on one end of assembly onto Connector **K3**, Use three (3) [DD] bolts and three (3) [KK] flat washers to attach one (1) assembly **J3**, **K3**, **J3**, **K3**, **J3**, **K3** to middle cross beams **G4**. Repeat with the other assembly.

[DD] x6
[KK] x6

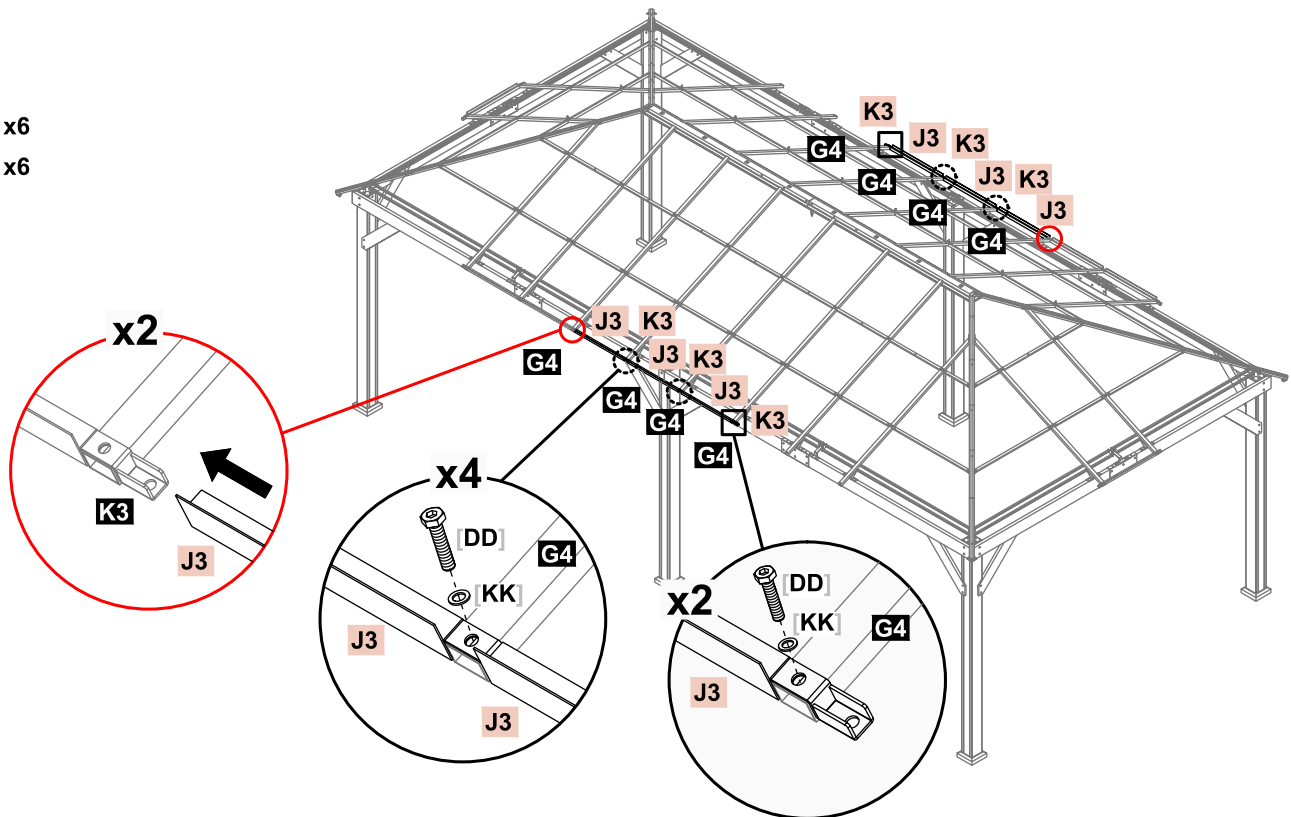

STEP 33

Slide roof border **J3** on one end of assembly onto Connector **K3**, Use two (2) **[DD]** bolts and two (2) **[KK]** flat washers to attach one (1) assembly **J3**, **K3**, **J3**, **K3** to middle cross beams **G4** and **G6**. Repeat with the other assembly.

[DD] x4

[KK] x4

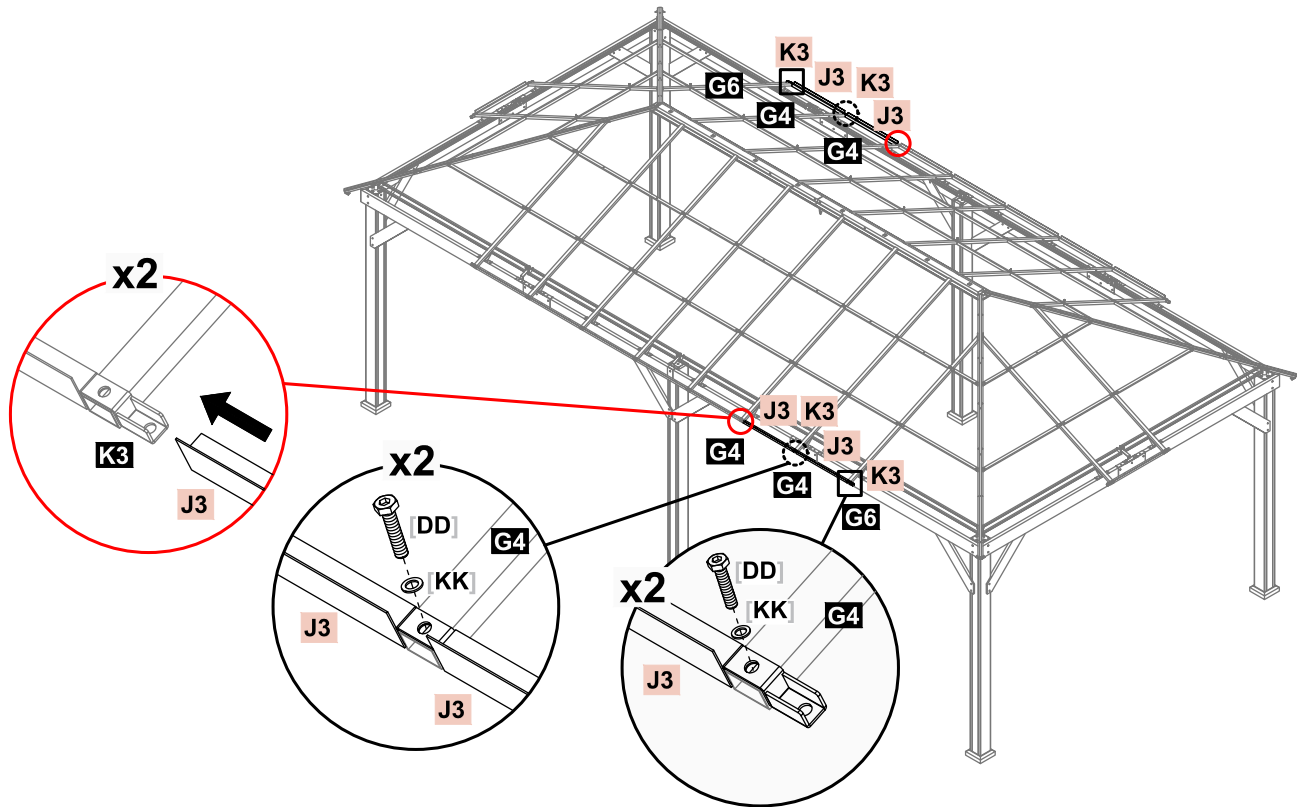

STEP 34

Slide roof border **J1** onto **G5 / G6**. Use one (1) **[DD]** and one (1) **[KK]** flat washer to attach **J1** to roof rib **F4 F5**. Repeat with the other three (3) **J1** and four (4) **J2**.

[KK] x8

[DD] x8

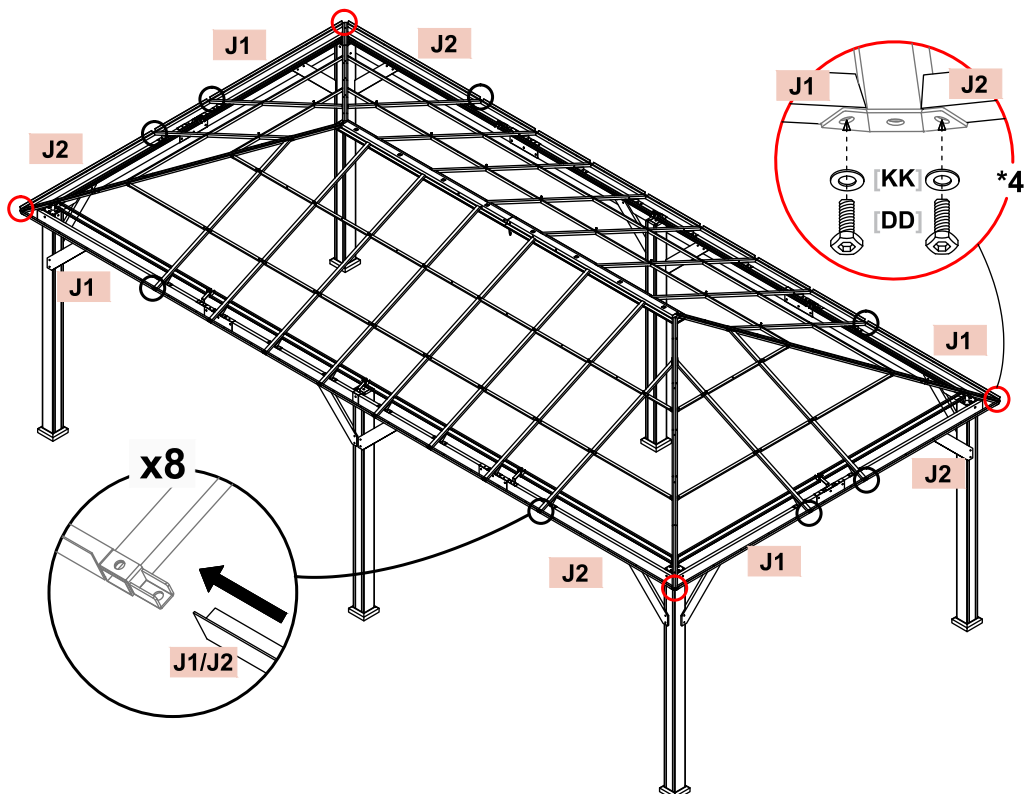

STEP 35

Use two (2) [DD] bolts and two (2) [KK] flat washers to attach one (1) connector **K7** to roof borders. Repeat with the other nineteen (19) connectors **K7**.

[KK] x40

[DD] x40

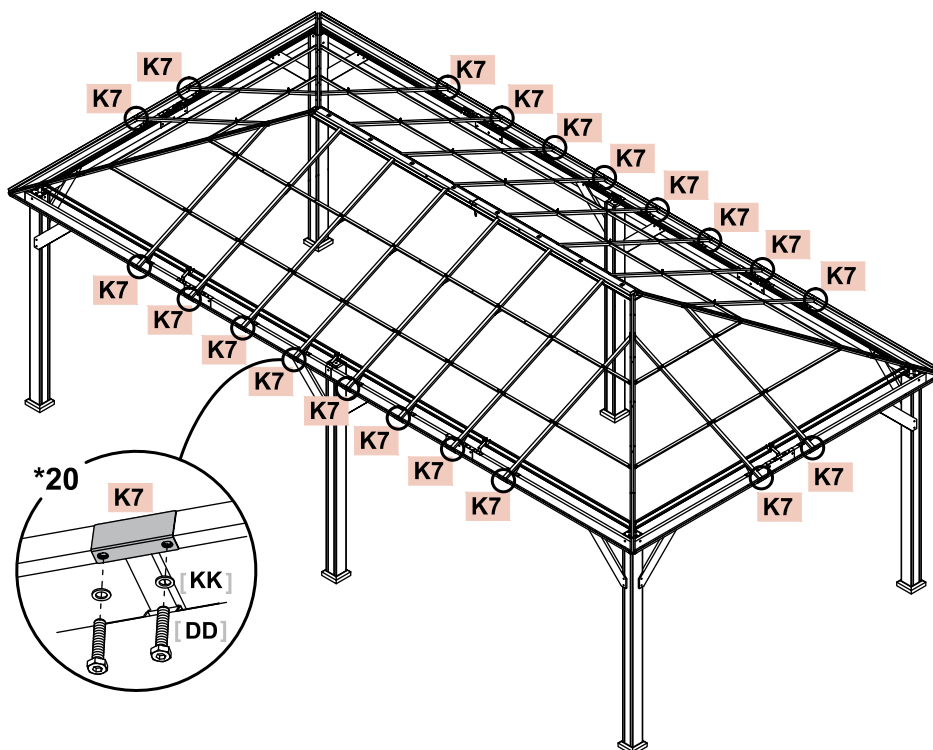
**STEP 36**

Use four (4) [AA] bolts to attach each connector **K1** to cross beams.

[AA] x80

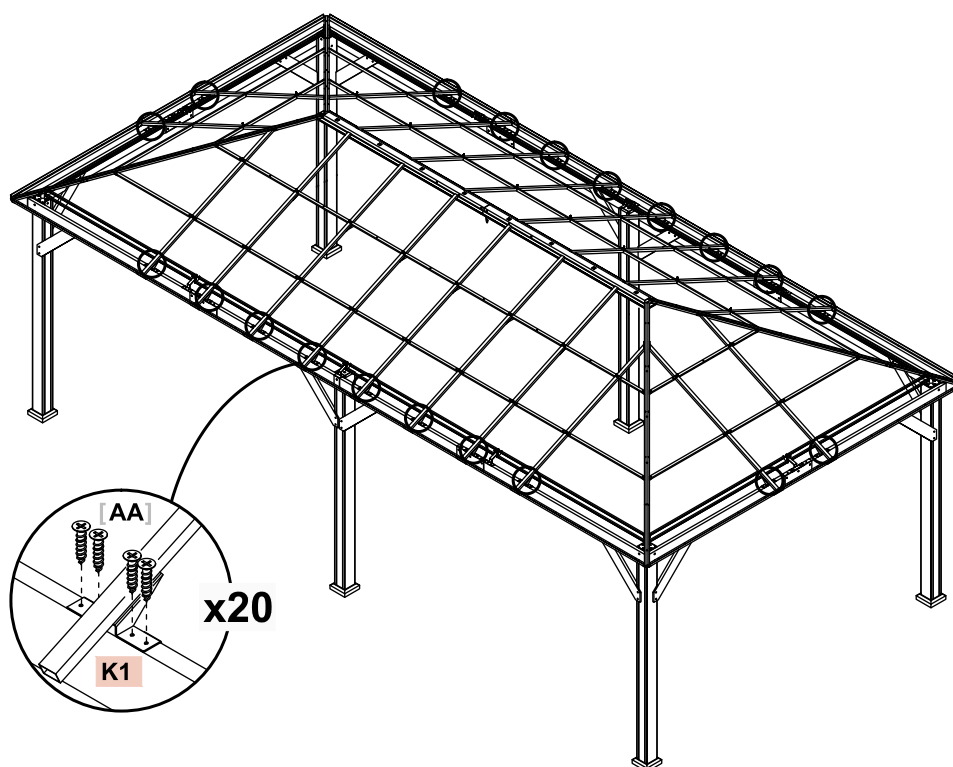

STEP 37

Use two (2) [VV] bolts and two (2) [KK] flat washers to attach one (1) middle cross beam support P3 to middle cross beam G4. Repeat with the other five (5) P3.

[KK] x12

[VV] x12

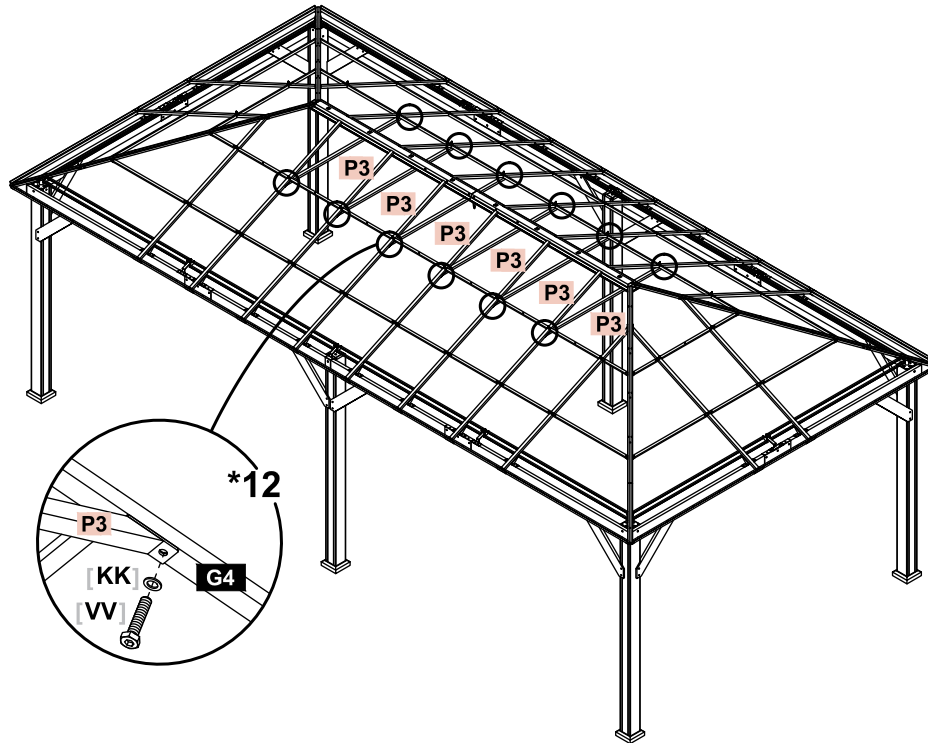

STEP 38

DO NOT tighten the bolts completely until all the bolts and washers are properly installed.

Overlap the edges of the adjacent roof plates together.

Use one (1) [DD] bolt and one (1) [KK] flat washer to attach each hole of roof plates Z19 to the frame.

[KK] x32

[DD] x32

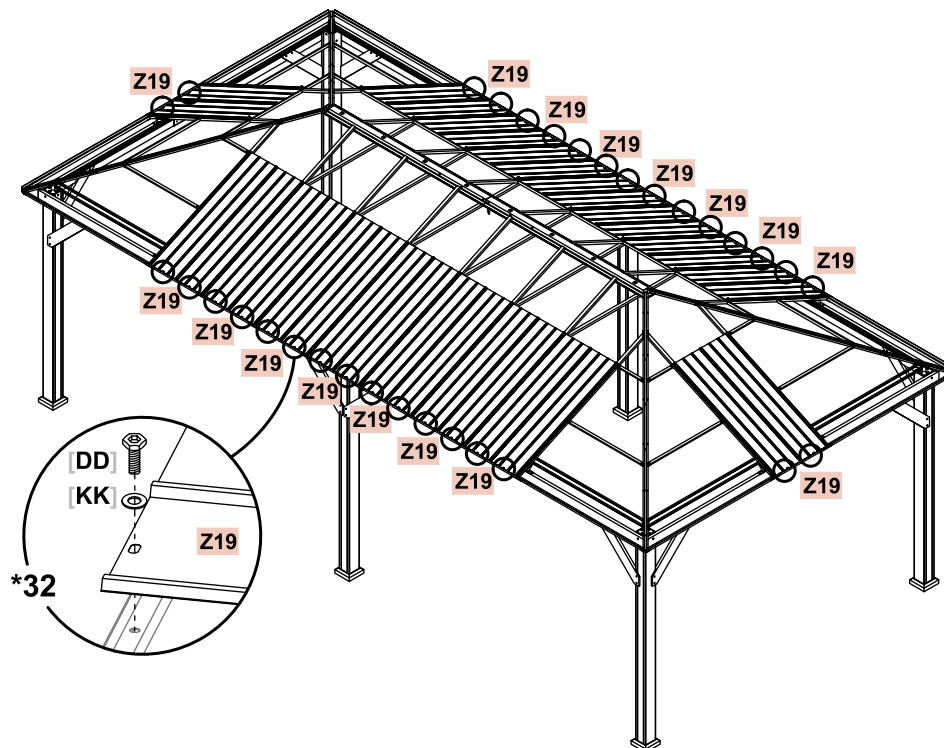

STEP 39

Overlap the edges of the adjacent roof plates together.

Use one (1) [ZZ] ball nut, one (1) [ZX] sealant washer and one (1) [ZY] flat washer to attach each hole in the black circle of roof plates Z18 to the [YY] screw.

Use one (1) [ZV] bolt, one (1) [ZX] sealant washer and one (1) [ZY] flat washer to attach each hole in the red circle of roof plates Z18 to the frame.

- [ZZ] x8
- [ZX] x18
- [ZY] x18
- [ZV] x10

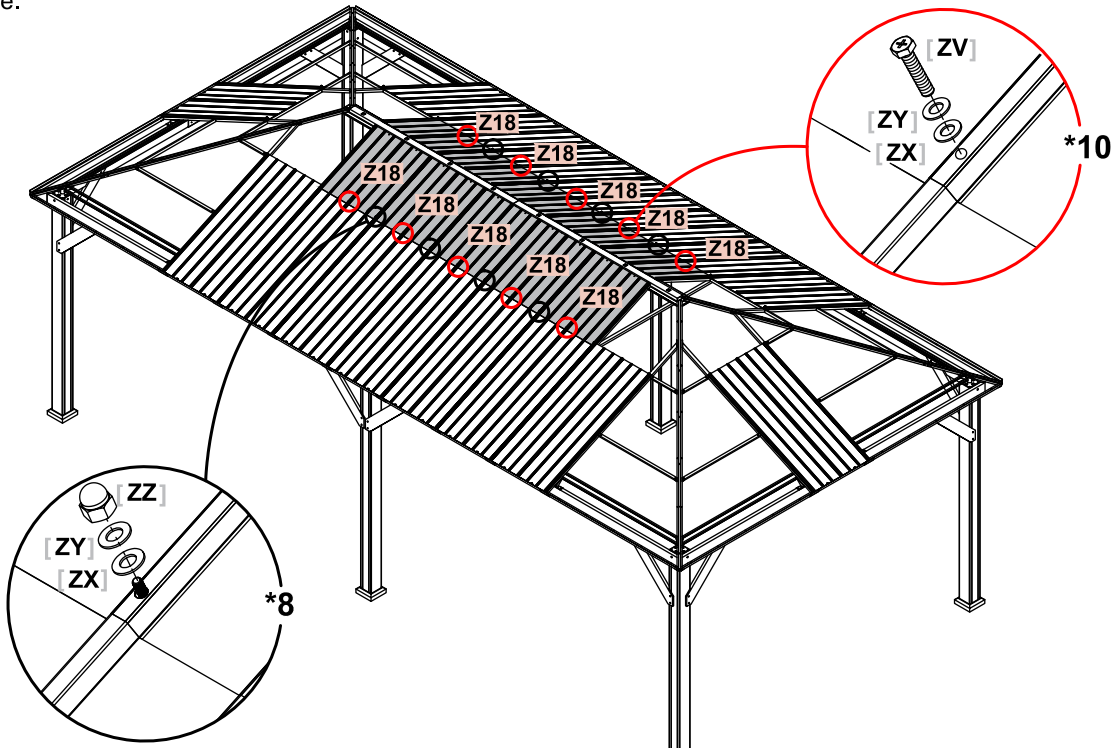

STEP 40

Overlap the edges of the adjacent roof plates together.

Use one (1) [DD] bolt and one (1) [KK] flat washer to attach each hole on the roof plates Z15, Z16 and Z17 to the frame.

Use one (1) [ZZ] ball nut, one (1) [ZX] sealant washer and one (1) [ZY] flat washer to attach each hole in the red circle of lower end of roof plates Z16 and Z17 to the [YY] screw.

Use one (1) [ZV] bolt, one (1) [ZX] sealant washer and one (1) [ZY] flat washer to attach each hole in the black circle of roof plates Z15, Z16 and Z17 to the frame.

- [ZZ] x4 [ZV] x6
- [ZX] x10 [DD] x8
- [ZY] x10 [KK] x8

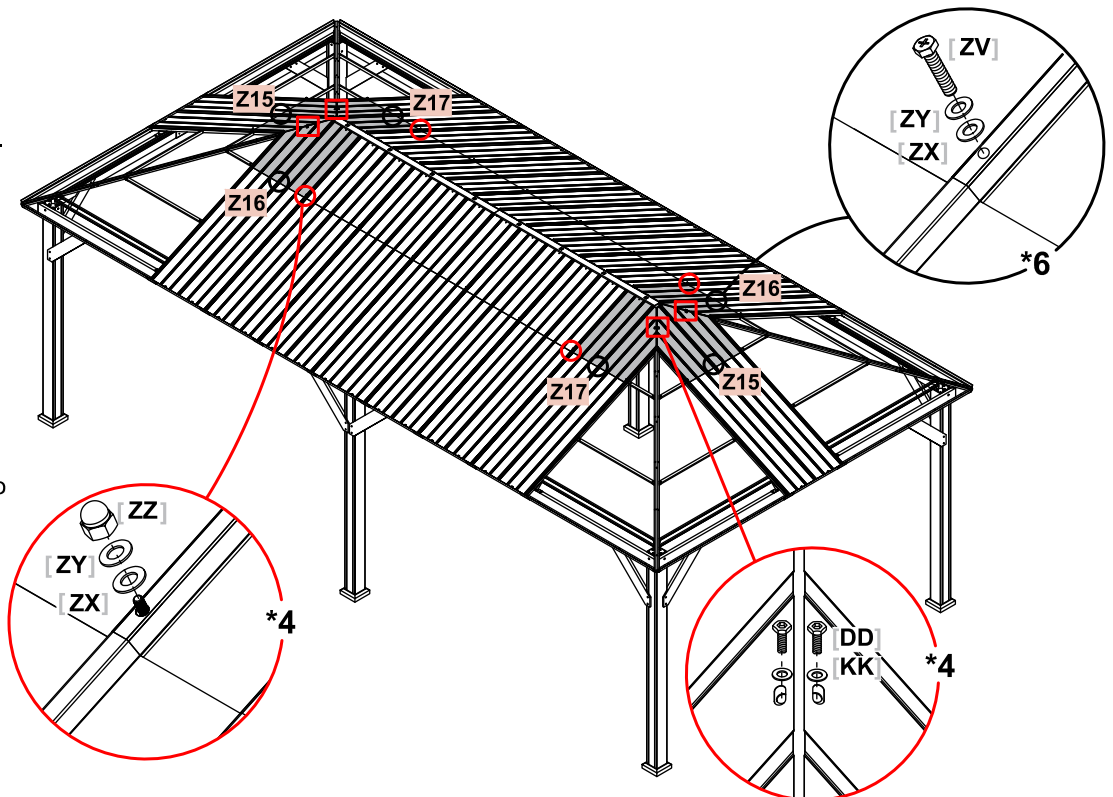

STEP 41

Slide roof cover **L11** to **L12**. Use one (8) **[EE]** bolt and eight (8) **[KK]** flat washer to attach roof cover **L11** **L12** to connector **K21**.

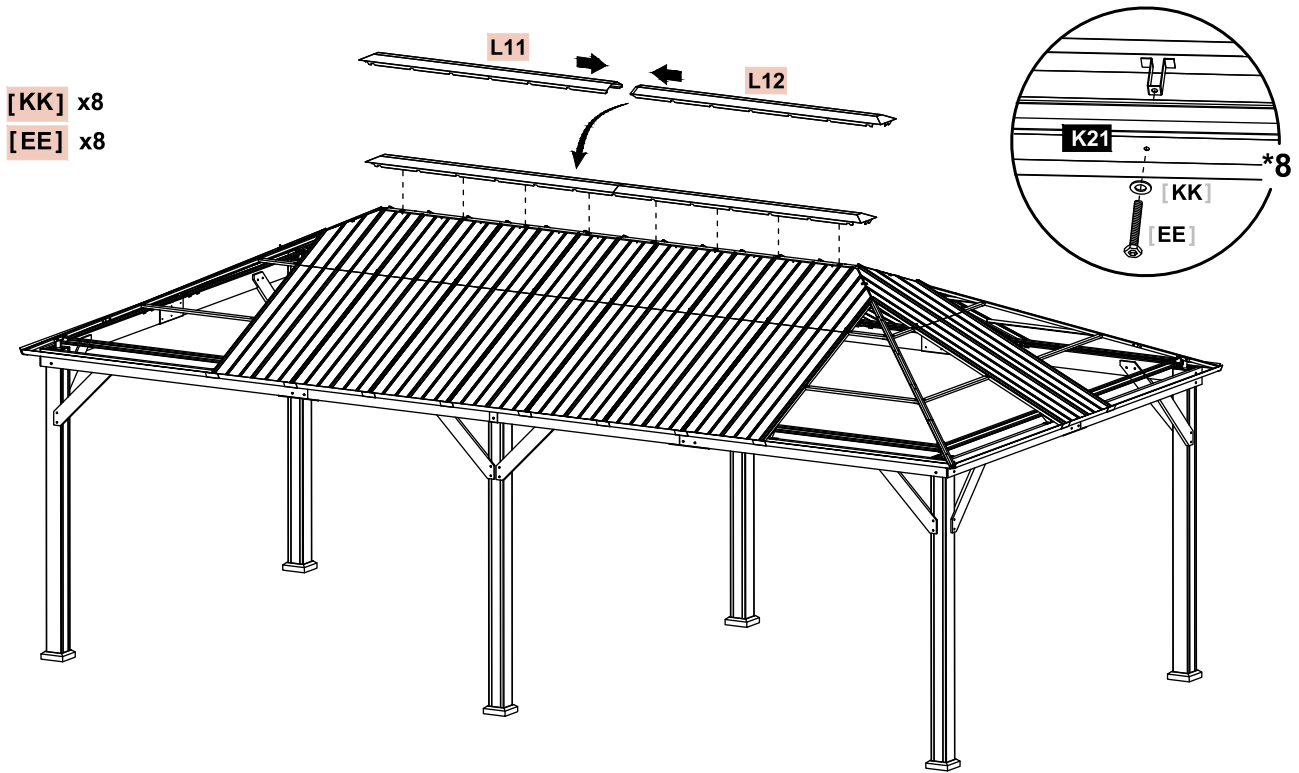

STEP 42

Overlap the edges of the adjacent roof plates together. Use one (1) **[DD]** bolt and one (1) **[KK]** flat washer to attach each hole of roof plates **Z21** and **Z22** to the frame.

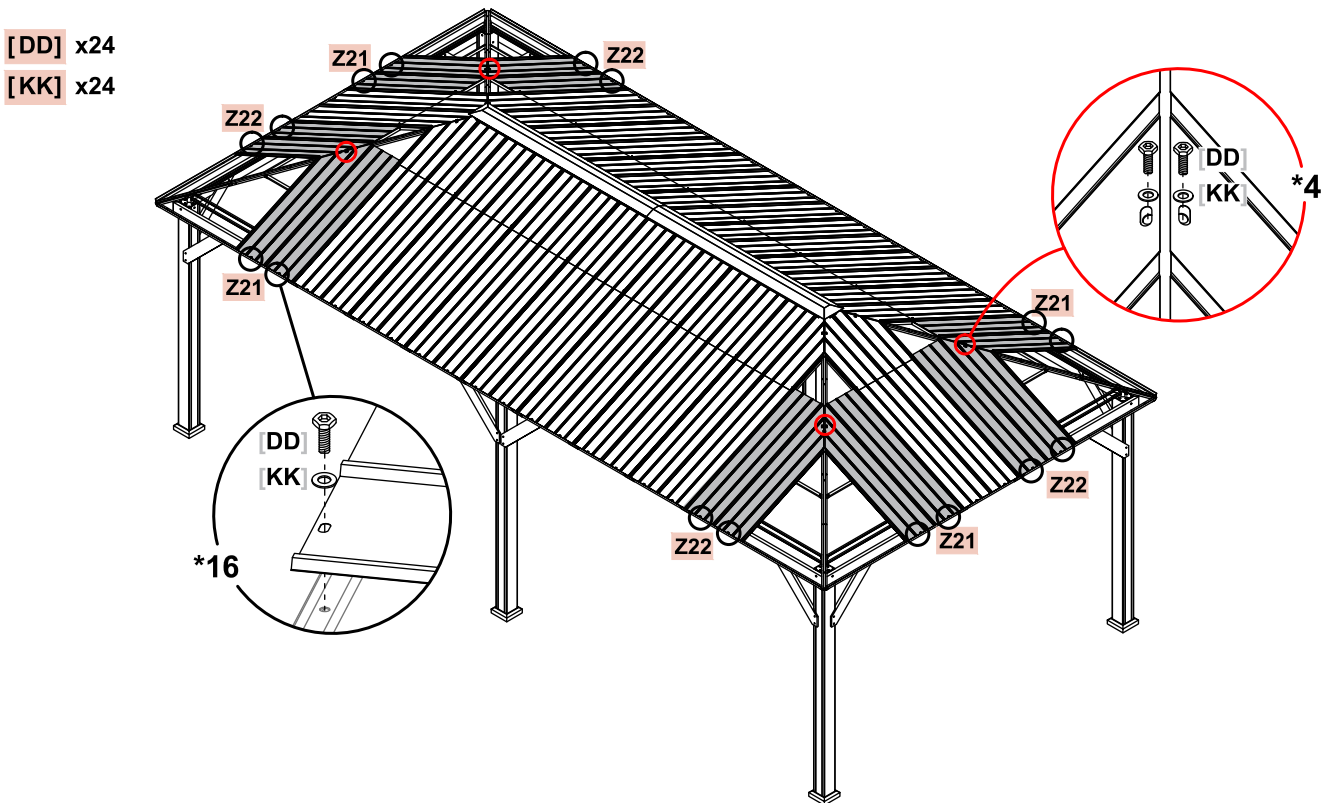

STEP 43

Use one (1) [DD] bolt and one (1) [KK] flat washer to attach each hole on the roof plates **Z23** and **Z24** to the frame.

Use one (1) [ZZ] ball nut, one (1) [ZX] sealant washer and one (1) [ZY] flat washer to attach each hole in the black circle of lower end of roof plates **Z23** and **Z24** to the [YY] screw.

[ZZ] x8
 [ZX] x8
 [ZY] x8
 [DD] x8
 [KK] x8

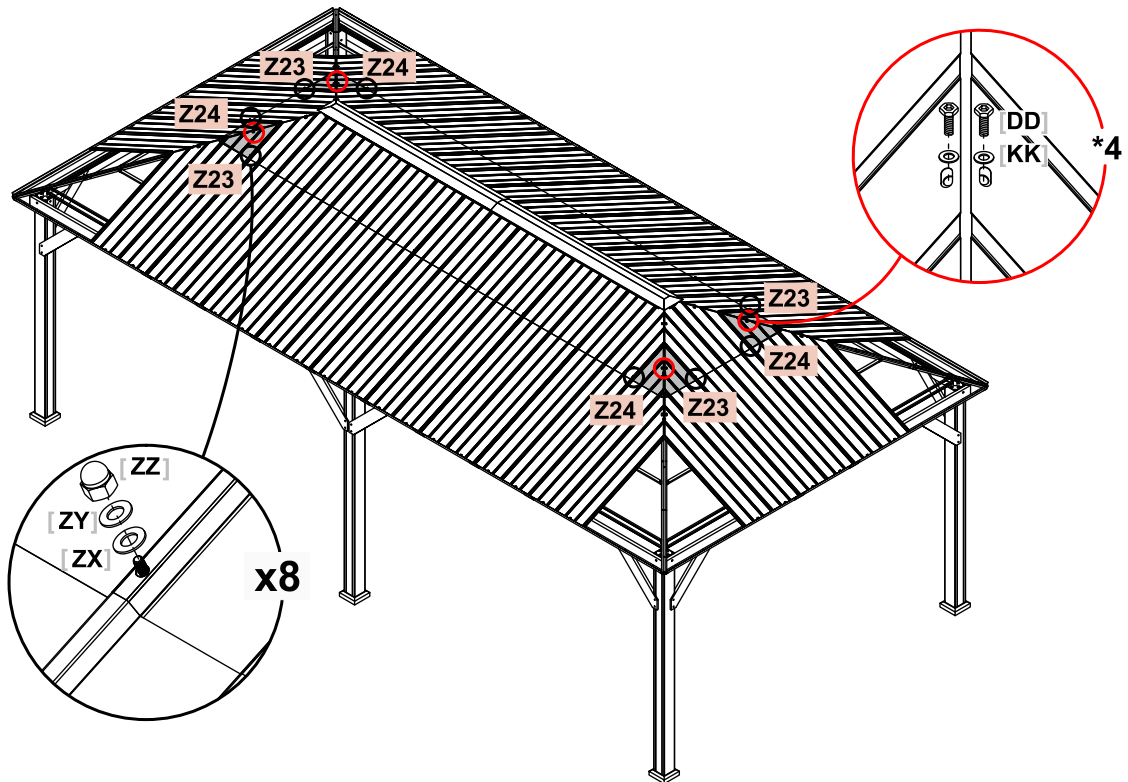
**STEP 44**

Use two (2) [EE], two (2) [KK] flat washers and two (2) [NN] flat washers to attach one (1) roof rib cover **L9** to the roof. Repeat with the other three (3) roof rib covers **L9**.

[EE] x8
 [KK] x8
 [NN] x8

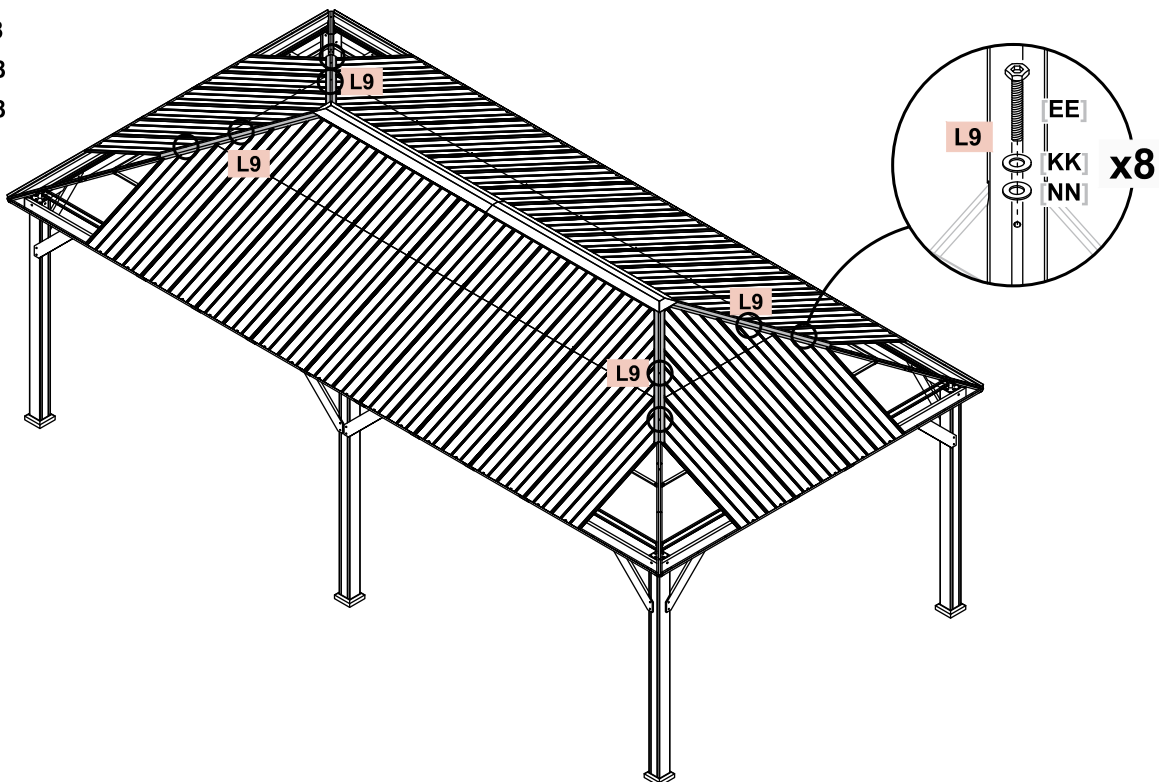

STEP 45

Use one (1) [DD] bolt and one (1) [KK] flat washer to attach each top hole of roof plates Z4, Z5, Z6 and Z7 to the frame.

[DD] x32

[KK] x32

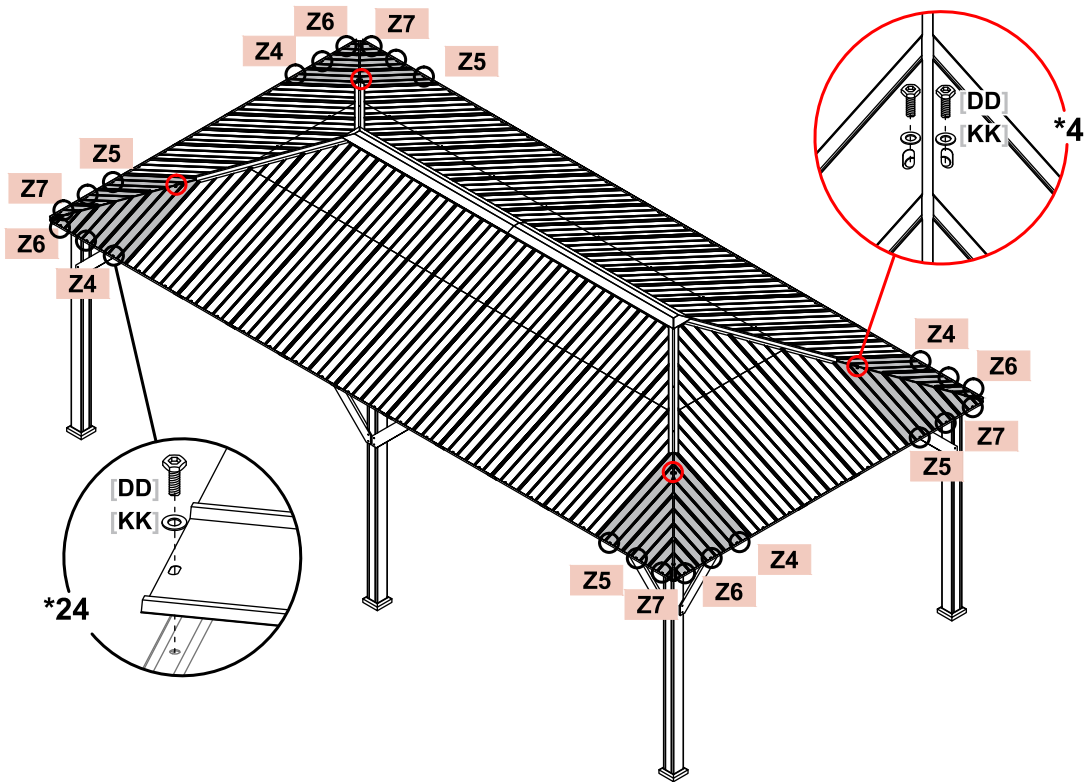

STEP 46

Slide roof rib cover L10 into L9. Use two (2) [EE], two (2) [KK] flat washers and two (2) [NN] flat washers to attach one (1) roof rib cover L10 to the roof. Repeat with the other three (3) roof rib covers L10.

[EE] x8

[KK] x8

[NN] x8

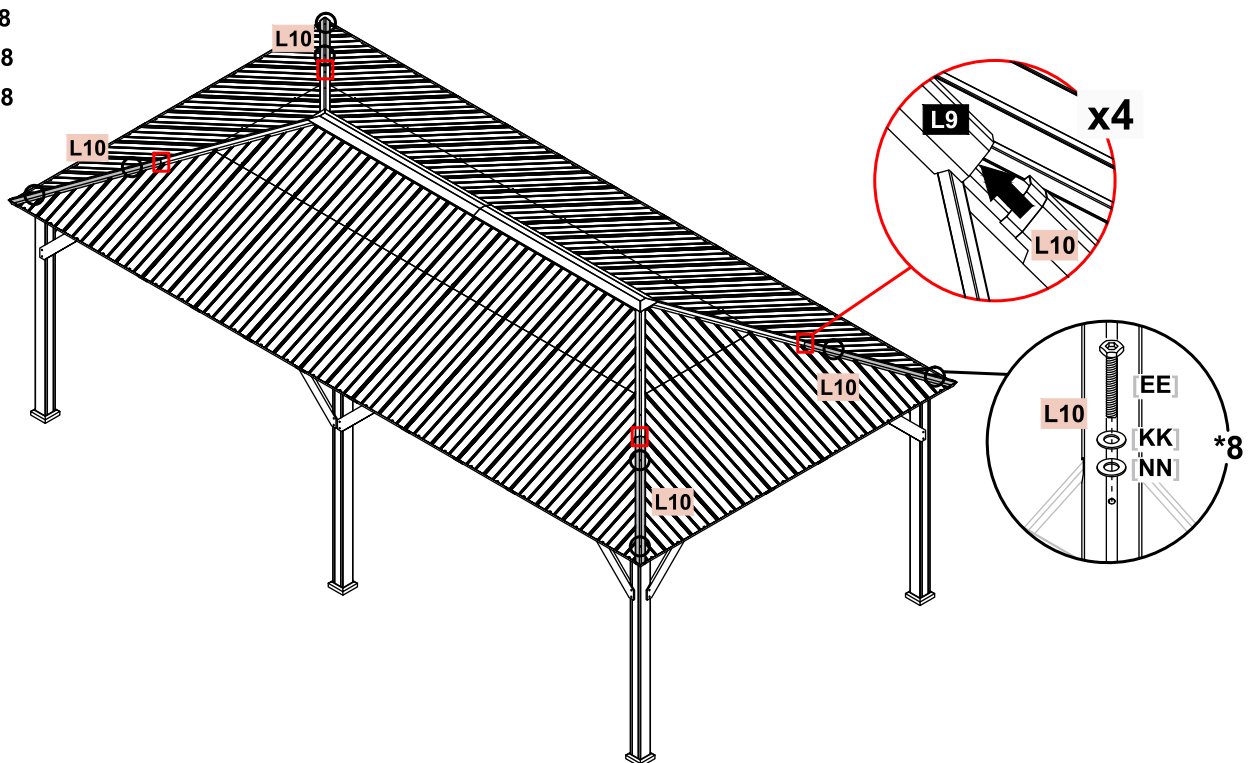

STEP 47

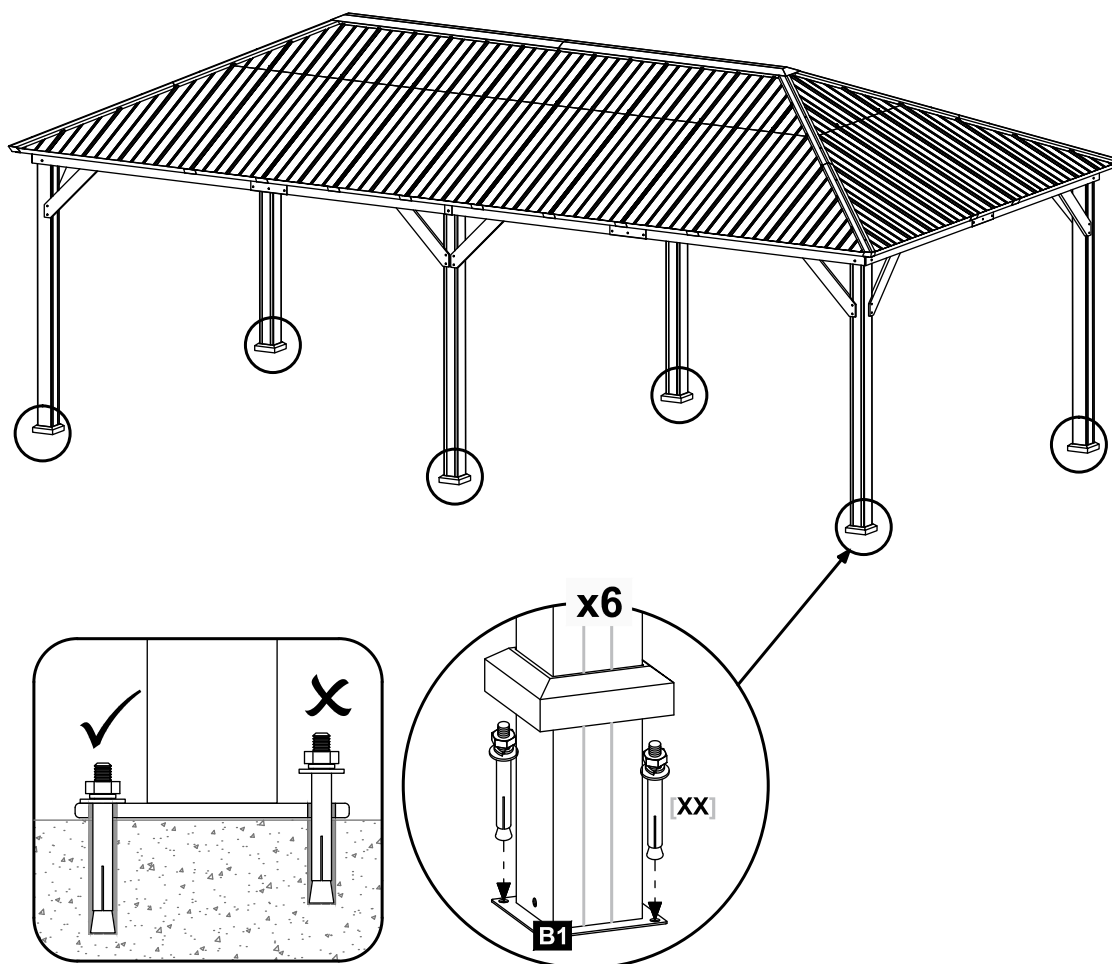

Use two (2) **[XX]** expansion bolts to anchor each post foot base **B1**. please make sure the expansion bolts are fully anchored. We recommend using a 3/8 inch drill bit when installing the included expansion bolts.

[XX] x12

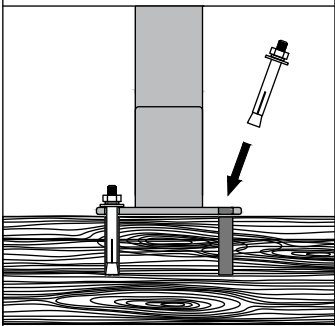
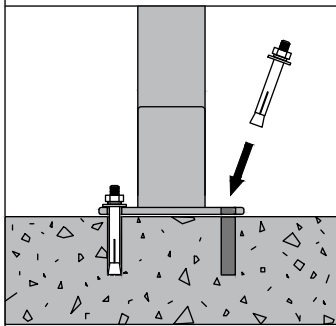

Outdoor Structure anchoring guide for anchoring gazebo to wood or concrete: If step 47, on page 28 in the assembly instructions is not properly completed, this will void the warranty.

WARNING! If your gazebo is not properly anchored, damage could occur. It is highly recommended for maximum safety that you mount and secure to wood or concrete footers. This is far better and safer than using ground stakes. The following are some examples of how to mount the structure to wood or concrete surfaces. Refer to local building codes or consider consulting a licensed contractor for assistance in the anchoring of this product.

WOOD	CONCRETE
	
<p>Anchors should be drilled into joists or reinforced blocking (not only deck boards).</p>  <p>Recommended Hardware: Expansion Bolt</p>	<p>Pre-drill holes for appropriately sized concrete anchors.</p>  <p>Recommended Hardware: Expansion Bolt</p>

If digging for foundation, please double check for possibility of any underground utilities such as gas, telephone, cable or sprinkler lines. Refer to your local building and city codes, ordinances, neighborhood covenants, or height restrictions regarding this type of structure for guidance on acceptable installation requirements.

CAUTION
DO NOT climb or walk on roof for any reason.

- Our components are intended for privacy, decorative and ornamental use only.
- Product is NOT INTENDED for the following:
 - A safety barrier to prevent unsupervised access to pools, hot tubs, spas or ponds.
 - As load bearing support for a building, structure, heavy objects or swings.
 - Used in structures that trap wind, rain or snow that would create extra load on the product.
 - Accumulated snow must be removed from roof.
 - DO NOT climb or walk on roof for any reason.

LIMITED WARRANTY

We warrants this product against defects in materials and workmanship for a period of one (1) year from the original date of purchase. To the extent any such defects occur, our products will send the appropriate replacement part(s) at no charge.

This warranty does not cover:

- Inspection costs or labor for replacement of any defective parts);
- Incidental or consequential damages;
- Cosmetic defects which DO NOT affect performance;
- Normal wear and tear;
- Damage due to vandalism; acts of nature, including but not limited to wind, storms, hail, floods;
- Improper assembly, installation, or use;
- Discoloration or fading of the finish as a result of exposure to chemicals, spills, pool or salt water
- Corrosion/ rust.

Your product has been designed for safety and quality.

Any modifications made to the original product could compromise its structural integrity or function, and could lead to product failure or personal injury. As such, modifying this product voids any and all warranties.

This product is warranted for RESIDENTIAL USE ONLY, and is not for commercial, contract or other non-residential purposes. Products disclaims all other representations and warranties of any kind, express or implied.

The warranty applies to the original purchaser and is non-transferable. It does not apply to purchases of display models, or when the product is sold on clearance or "as is".

We makes no warranty whatsoever in respect to accessories or parts not supplied with it. This warranty shall apply only within the boundaries of the United States of America and Canada. This warranty gives the original purchaser specific rights, and the original purchaser may also have other rights, which vary from state to state.

