

# ASSEMBLY INSTRUCTION

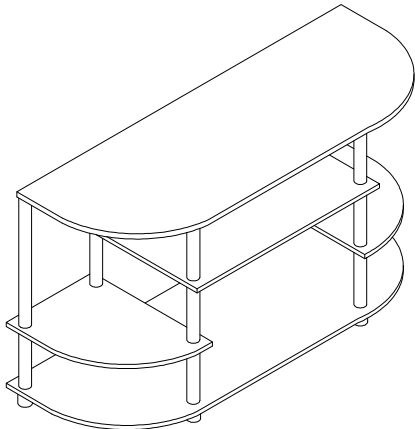



## IMPORTANT NOTE:

- Place all wooden parts on a clean and smooth surface such as a rug or carpet to avoid the parts from being scratched.
- Check to be sure that you have all parts and hardware.
- Remove all wrapping materials, including staples & packing straps before you start to assemble.
- Do not tighten all screws/bolts until all completely assembled.
- Keep all hardware parts out of reach of children.

*Each Item*

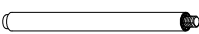
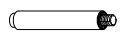
PARTS LIST		
NO	COMPONENT	QTY
A	TOP PANEL	1 PC
B	CENTER PANEL	1 PC
C	LEFT SHELF PANEL	1 PC
D	RIGHT SHELF PANEL	1 PC
E	BOTTOM PANEL	1 PC

HARDWARE LIST		
NO	DESCRIPTION	QTY
1	LONG ROUND POLE 	2 PCS
2	SHORT ROUND POLE 	14 PCS
3	INSERT CAP 	6 PCS
4	ROUND LEG 	6 PCS

### STEP 1

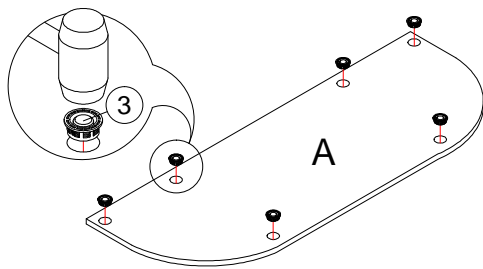

### STEP 2

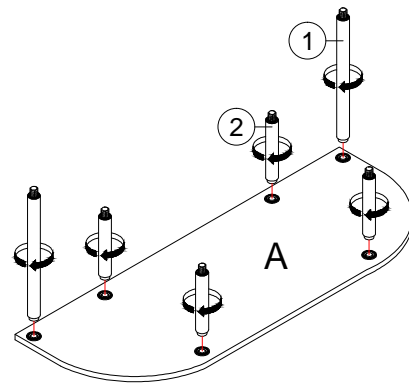

### STEP 3

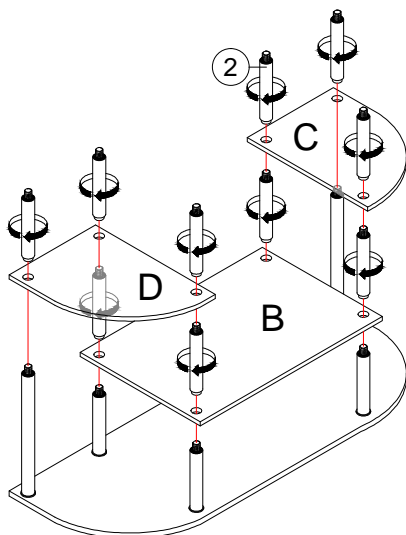

### STEP 4

