

## NOTICE

\*Please make sure that you have all parts indicated and they are in good condition before you begin assembly of this item. Refer to part list and hardware list below for guidance.

\*This item should be assembled on a soft surface to prevent scratching the finish during assembly.

\*This item may require periodic tightening.

\*If you are having difficulty, our friendly Customer Care team is always here to help. Please email [customersupport@safavieh.com](mailto:customersupport@safavieh.com)

## PREPARATION

\*Before beginning assembly of product, make sure all parts are present. Compare parts with part contents list and hardware contents list.

\*If any part is missing or damaged, do not attempt to assemble the product.









\*Tools Required for Assembly (included): Allen Key and Wrench Key

\*Estimated Assembly Time: 10 minutes.

## CARE AND MAINTENANCE

Store outdoor furniture indoors or cover well when not in use. Dust regularly with small brush or vacuum. Spills should be taken care of immediately before they harden or stain with a slightly damp sponge.

## Part List and Hardware List

PIECE	DESCRIPTION	PICTURE	QUANTITY				
A	Left Leg Panel		1x	F	Back Cushion		2x
B	Right Leg Panel		1x	HW1	Allen Key		1x
C	Back Leg Panel		1x	HW2	Allen screw M7x70mm		6x
D	Seat Panel		1x	HW3	Allen bolt M6x45mm		2x
E	Seat Cushion		1x				

 **SAFAVIEH**  
O U T D O O R

MODEL# PAT6808

PRODUCT DIMENSIONS:

CADORI BENCH : 53.94"W x 27.17"D x 28.74"H

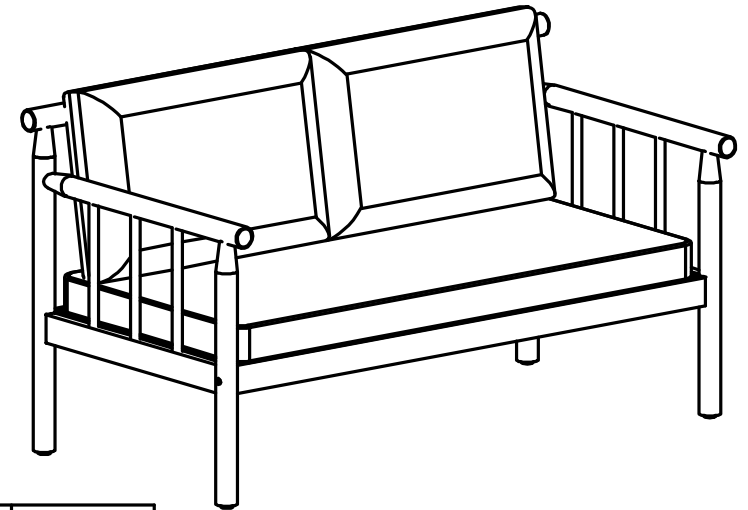

Weight capacity : 275 Lbs (single seat)

Warning : Do not stand on chair

Warning : Do not over torque bolts/screws

## PREPARATION

\*Before beginning assembly of product, make sure all parts are present. Compare parts with part contents list and hardware contents list.

\*If any part is missing or damaged, do not attempt to assemble the product.

\*Estimated Assembly Time: 10 minutes.

\*Tools Required for Assembly (included): Allen Key

\*If you are having difficulty, our friendly Customer care team is always here to help. Please email [customersupport@safavieh.com](mailto:customersupport@safavieh.com)

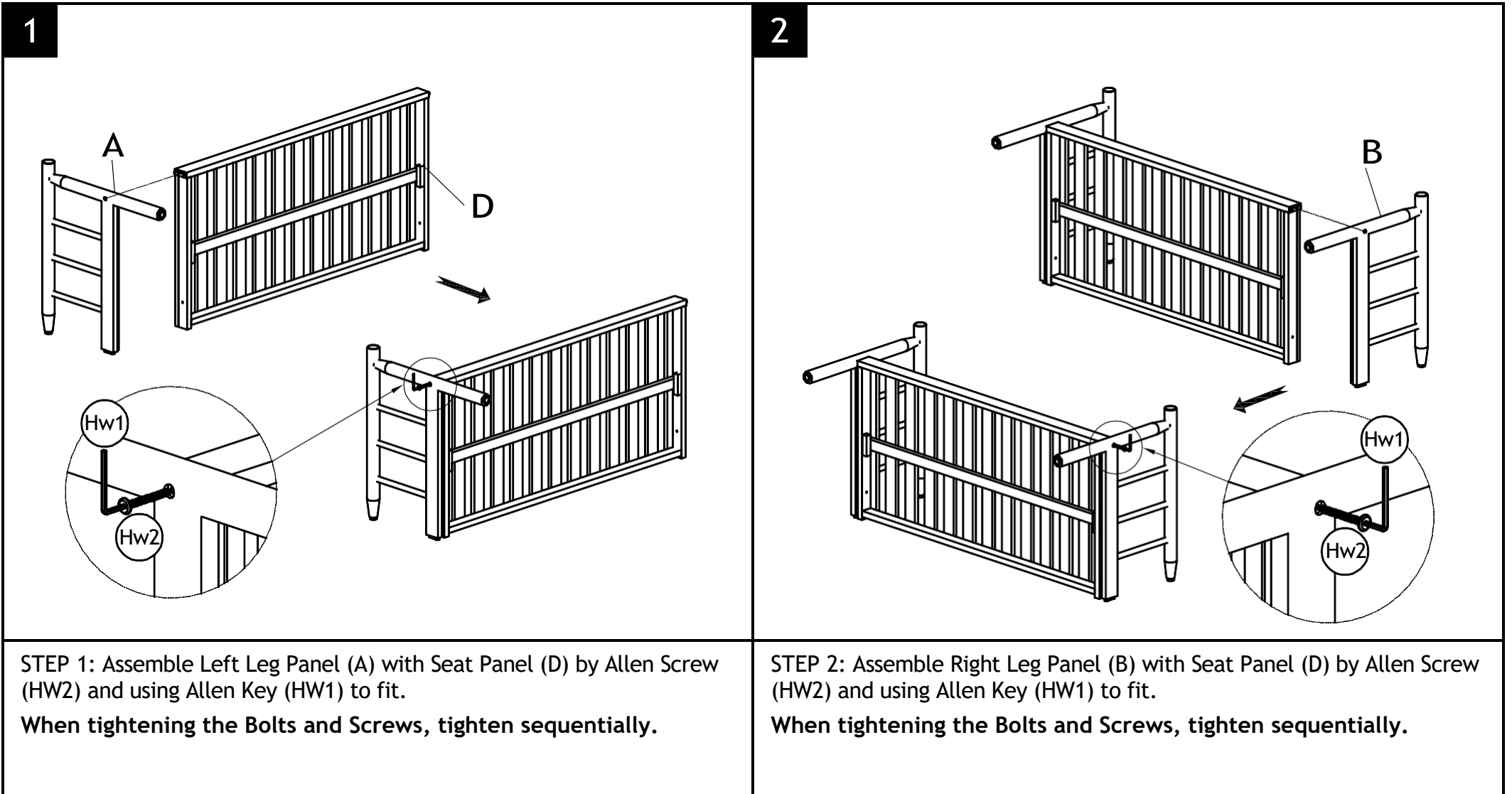

## PREPARATION

\*Before beginning assembly of product, make sure all parts are present. Compare parts with part contents list and hardware contents list.

\*If any part is missing or damaged, do not attempt to assemble the product.

\*Estimated Assembly Time: 10 minutes.

\*Tools Required for Assembly (included): Allen Key

\*If you are having difficulty, our friendly Customer care team is always here to help. Please email [customersupport@safavieh.com](mailto:customersupport@safavieh.com)

3

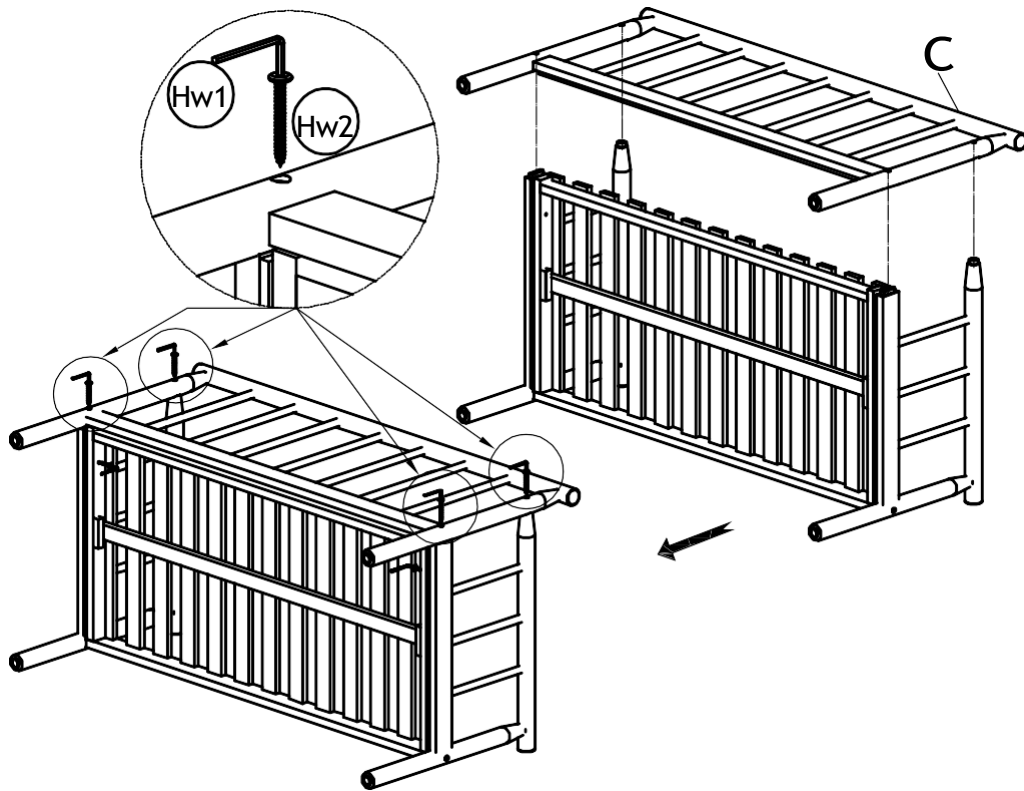

STEP 3: Assemble Back Leg Panel (C) with Left Leg Panel (A) and Right Leg Panel (B) with 4 Allen Screws (HW2) and use Allen Key (HW1) to fit.

**When tightening the Bolts and Screws, tighten sequentially.**

4

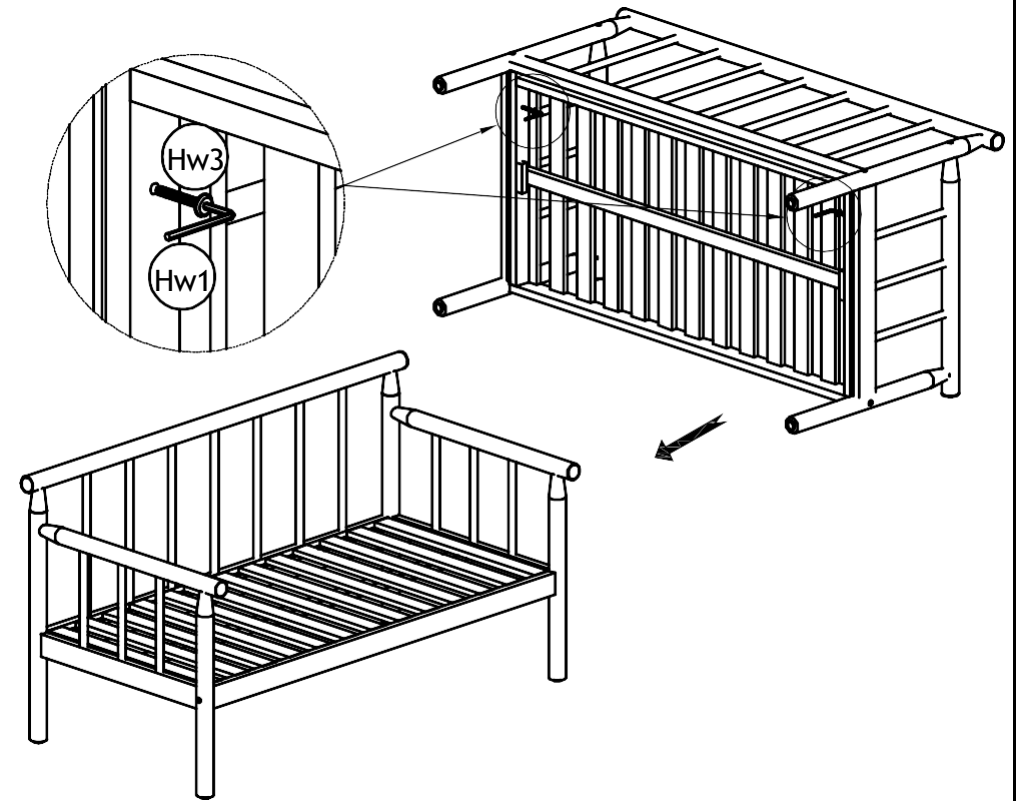

STEP 4: Assemble Seat Panel (D) with Left Leg Panel (A) and Right Leg Panel (B) with 2 Allen Bolts (HW3) and use Allen Key (HW1) to fit.

**When tightening the Bolts and Screws, tighten sequentially.**

## PREPARATION

\*Before beginning assembly of product, make sure all parts are present. Compare parts with part contents list and hardware contents list.

\*If any part is missing or damaged, do not attempt to assemble the product.

\*Estimated Assembly Time: 10 minutes.

\*Tools Required for Assembly (included): Allen Key

\*If you are having difficulty, our friendly Customer care team is always here to help. Please email [customersupport@safavieh.com](mailto:customersupport@safavieh.com)

5

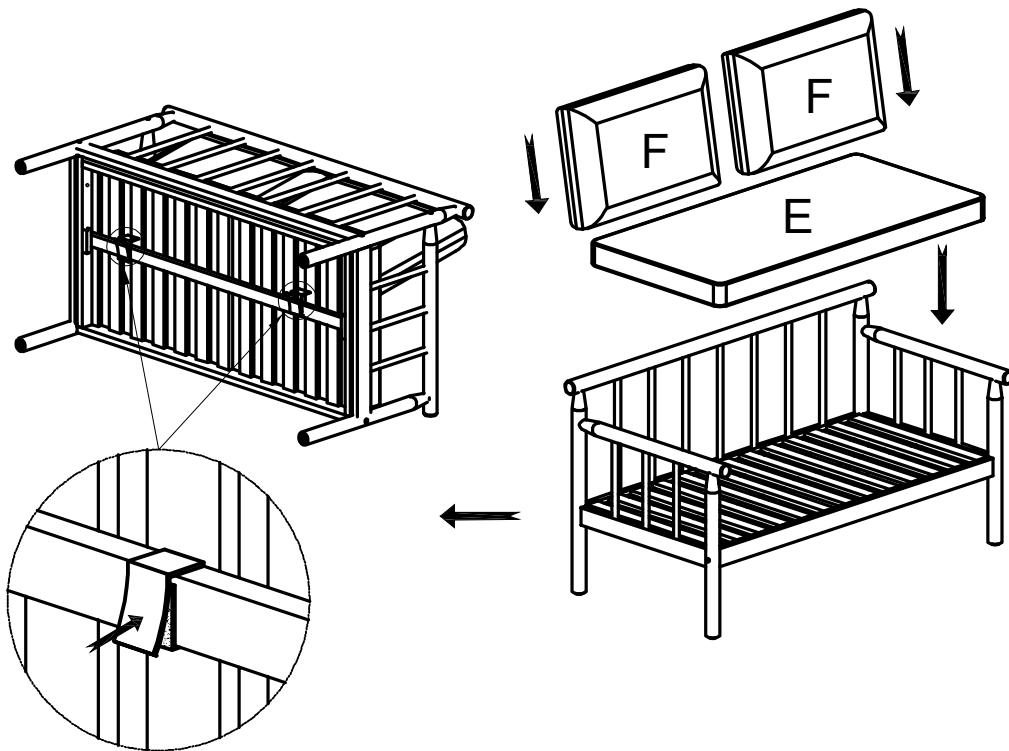

STEP 5: Place Seat Cushion (E) and Back Cushion (F) onto the Bench. Tie the velcro straps of Seat Cushion (E) to the support slat of Seat Panel (D) as shown above.

6

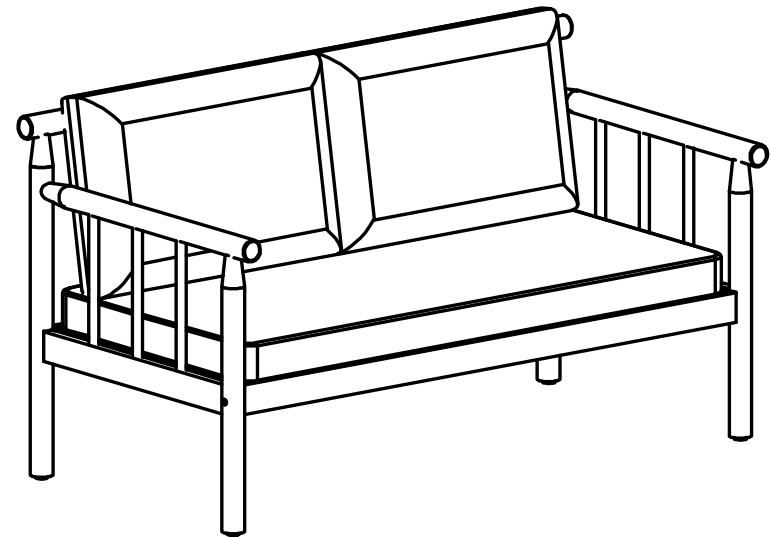

STEP 6: Inspect the Bench and make sure all parts are connected. Place Bench on a flat surface for use.