

WARNING!

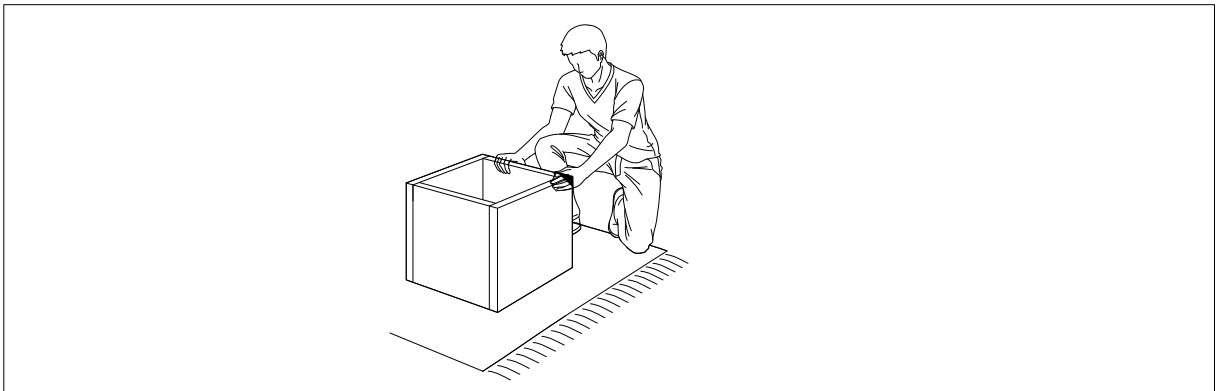

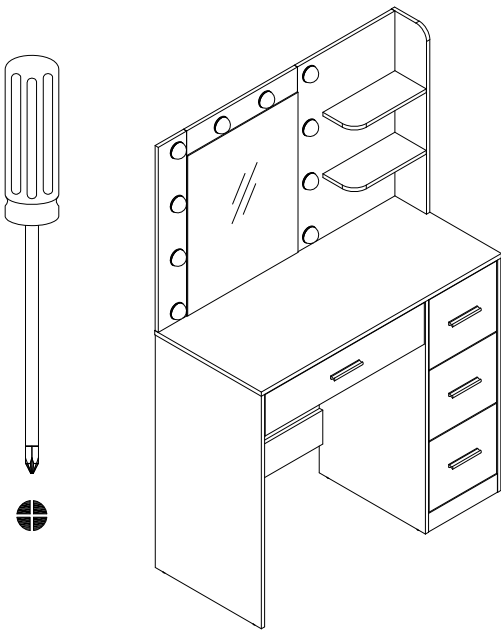

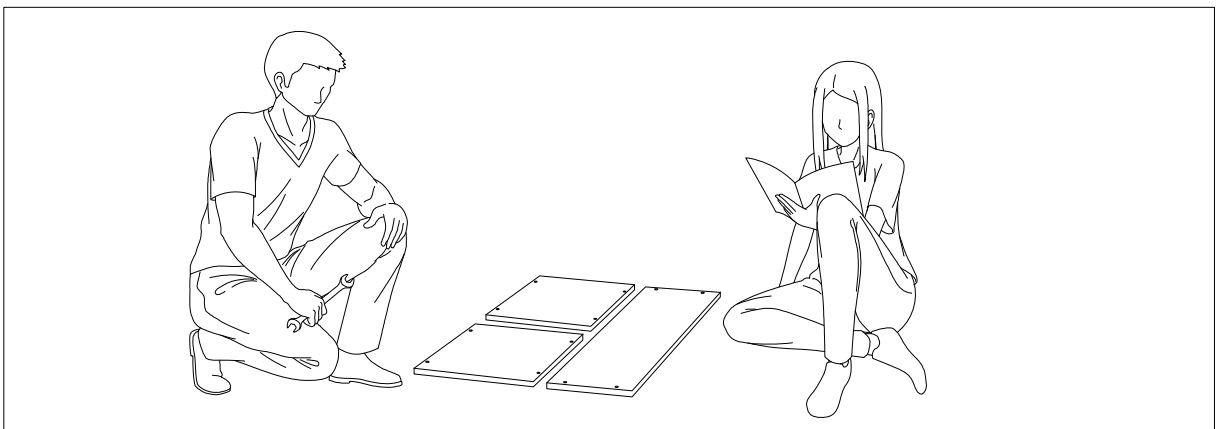



Assemble the furniture on empty carton, carpet, or rug to prevent scratches or damage.

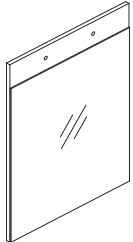
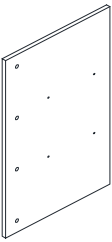

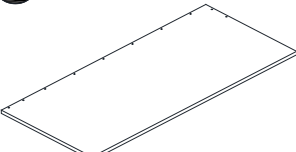
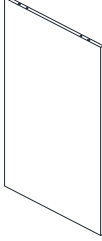
This furniture requires 2 people to assembly.
Make sure no parts are missing or damaged before assembly.

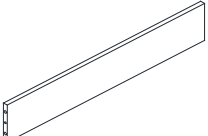
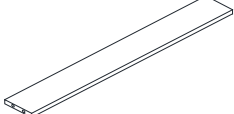
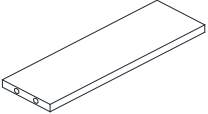
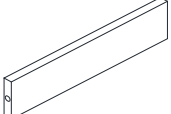
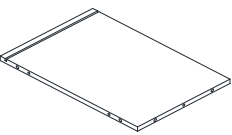

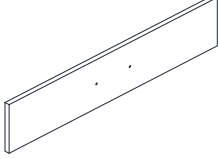
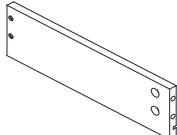
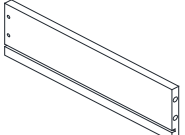
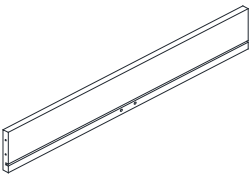
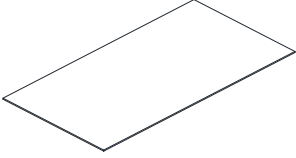
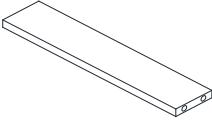
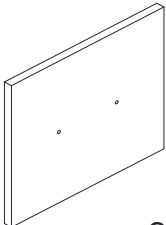
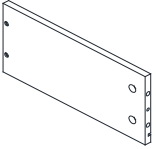
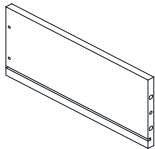
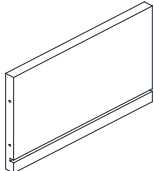
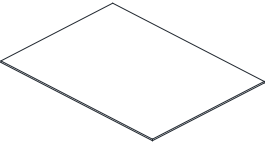



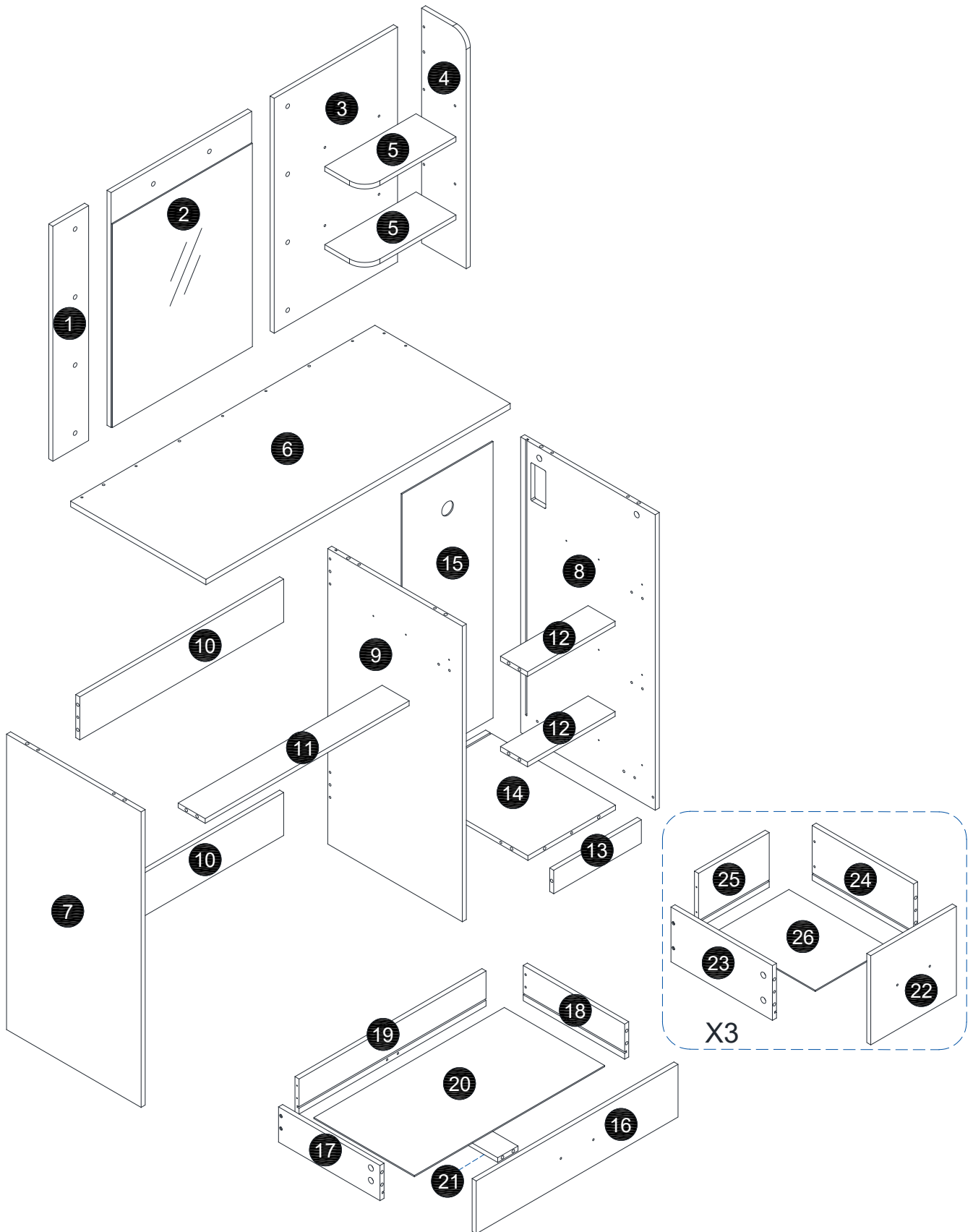

Not actual size

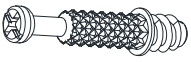
 <p>1 1PC</p>	 <p>2 1PC</p>	 <p>3 1PC</p>	 <p>4 1PC</p>	
 <p>5 2PCS</p>	 <p>6 1PC</p>	 <p>7 1PC</p>	 <p>8 1PC</p>	
 <p>9 1PC</p>	 <p>10 2PCS</p>	 <p>11 1PC</p>	 <p>12 2PCS</p>	 <p>13 1PC</p>
 <p>14 1PC</p>	 <p>15 1PC</p>	 <p>16 1PC</p>	 <p>17 1PC</p>	 <p>18 1PC</p>
 <p>19 1PC</p>	 <p>20 1PC</p>	 <p>21 1PC</p>	 <p>22 3PCS</p>	
 <p>23 3PCS</p>	 <p>24 3PCS</p>	 <p>25 3PCS</p>	 <p>26 3PCS</p>	

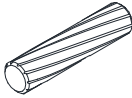
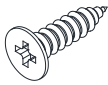
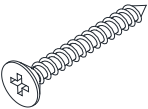
PACKAGE CONTENT

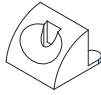
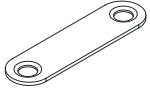
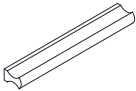
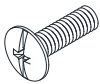
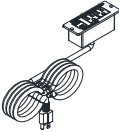

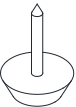
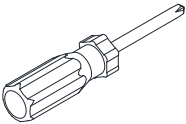
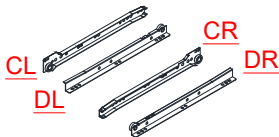
HARDWARE PART LIST

<p>A X62+2</p>  <p>Ø6x34mm</p>	<p>B X62+2</p>  <p>Ø15x9.5mm</p>	<p>C X27+1</p>  <p>Ø6x30mm</p>	<p>D X56+2</p>  <p>Ø6.5x12mm</p>
<p>E X25+1</p>  <p>Ø8*35mm</p>	<p>F X4</p>  <p>Ø3x15mm</p>	<p>G X4</p> 	<p>H X6</p> 
<p>I X4</p> 	<p>J X8</p>  <p>Ø5/23"x16mm</p>	<p>K X1</p> 	<p>L X1SET</p>  <p>L1 L2</p>
<p>M X6</p>  <p>Ø13x4mm</p>	<p>N X1</p> 	<p>O X4SET</p>  <p>CL DL CR DR</p> <p>L300mm</p>	<p>P X1SET</p>  <p>10PCS 1PC</p>
<p>Q X1</p> 			

Cam Lock Fastening System

Insert the cam bolt into the hole first, then insert the cam lock and lock it.

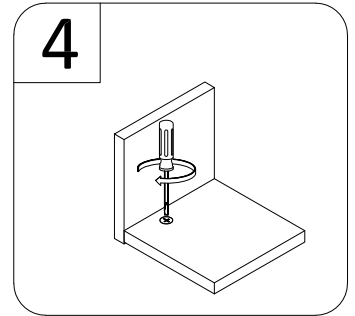
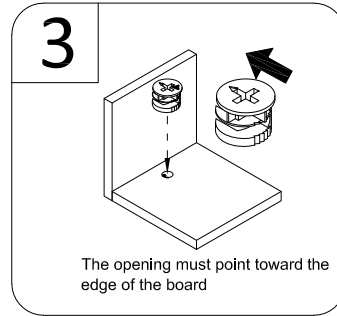
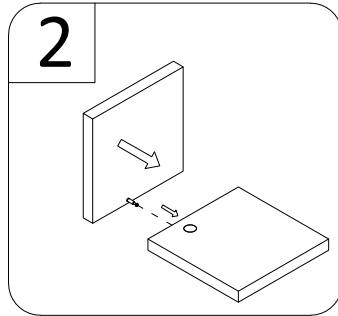
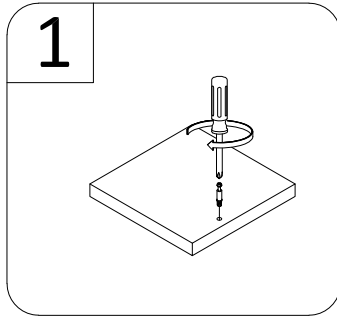

STEP 1

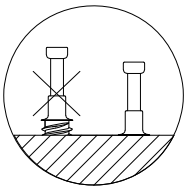
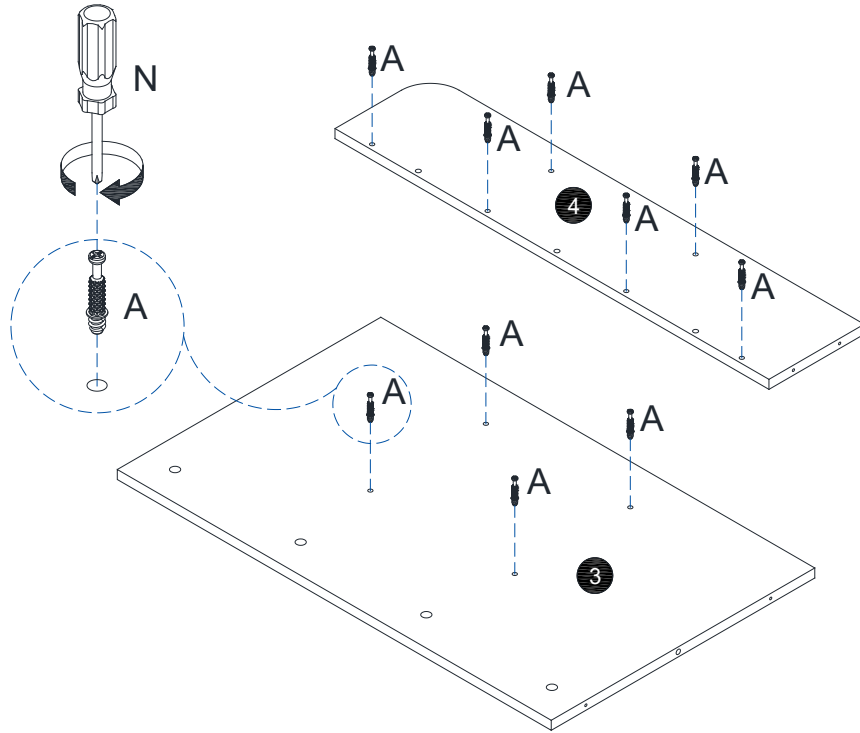
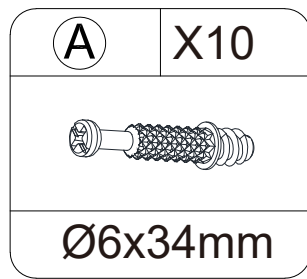
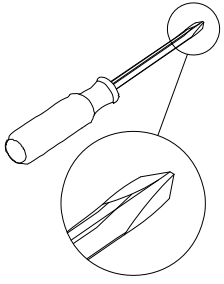

STEP 2

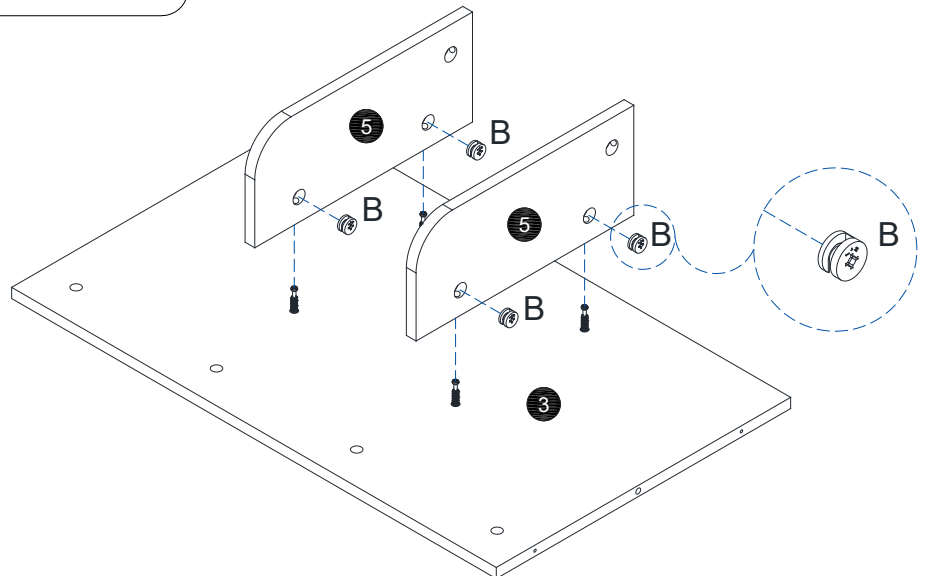
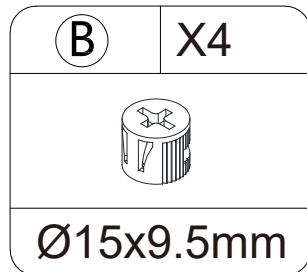
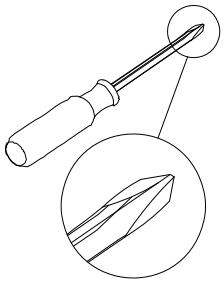

Insert the cam bolt into the hole first, then insert the cam lock and lock it.

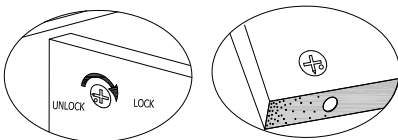

Proper orientation of CAM LOCK

STEP 3

(B)	X2
	
Ø15x9.5mm	

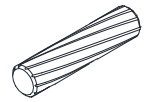
(C)	X3
	
Ø6*30mm	

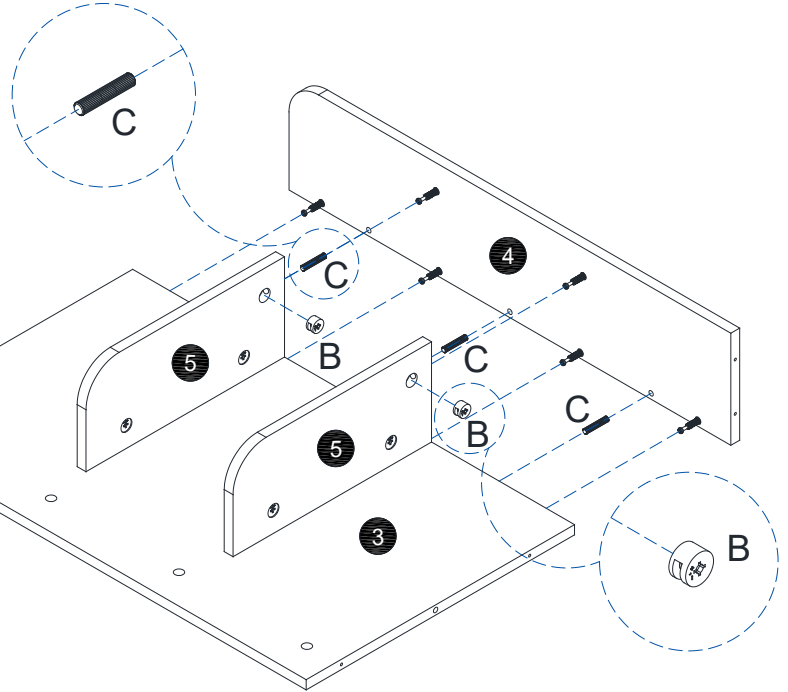
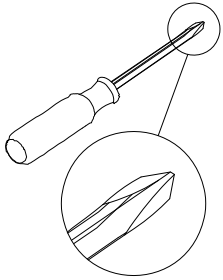

Insert the cam bolt into the hole first, then insert the cam lock and lock it.

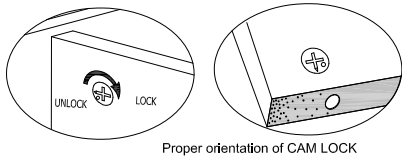

STEP 4

(B)	X4
	
Ø15x9.5mm	

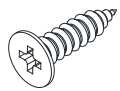
(D)	X3
	
Ø6.5x12mm	

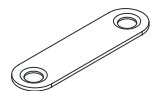
(H)	X3
	

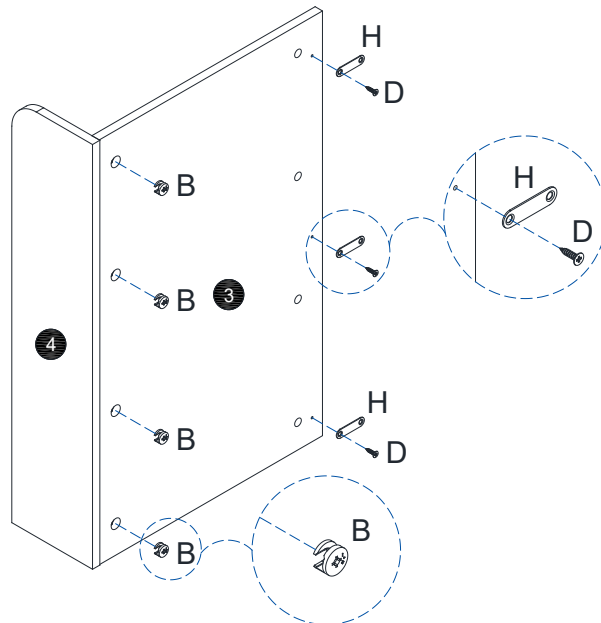
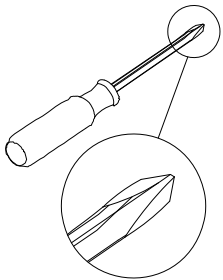

Insert the cam bolt into the hole first, then insert the cam lock and lock it.

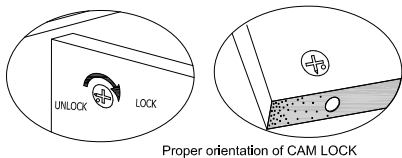

STEP 5

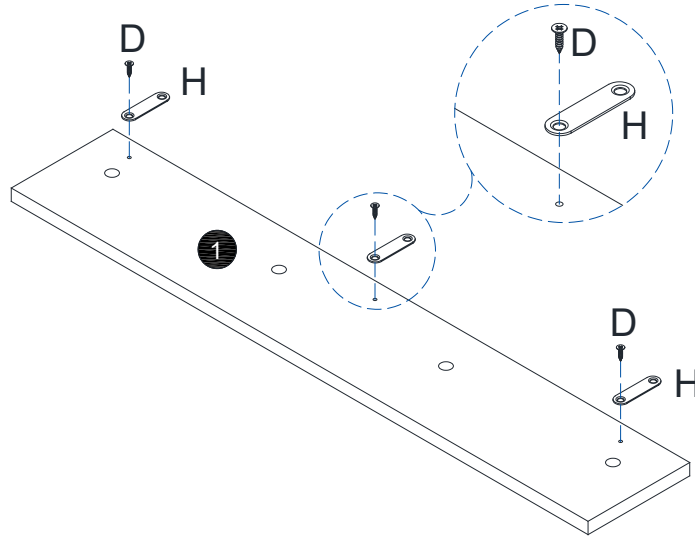
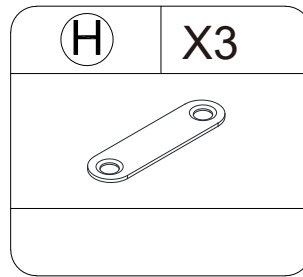
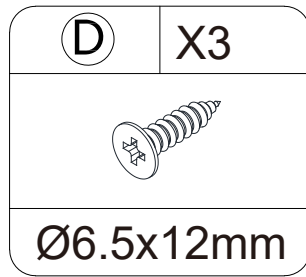
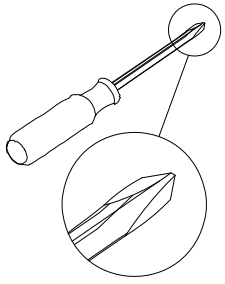

STEP 6

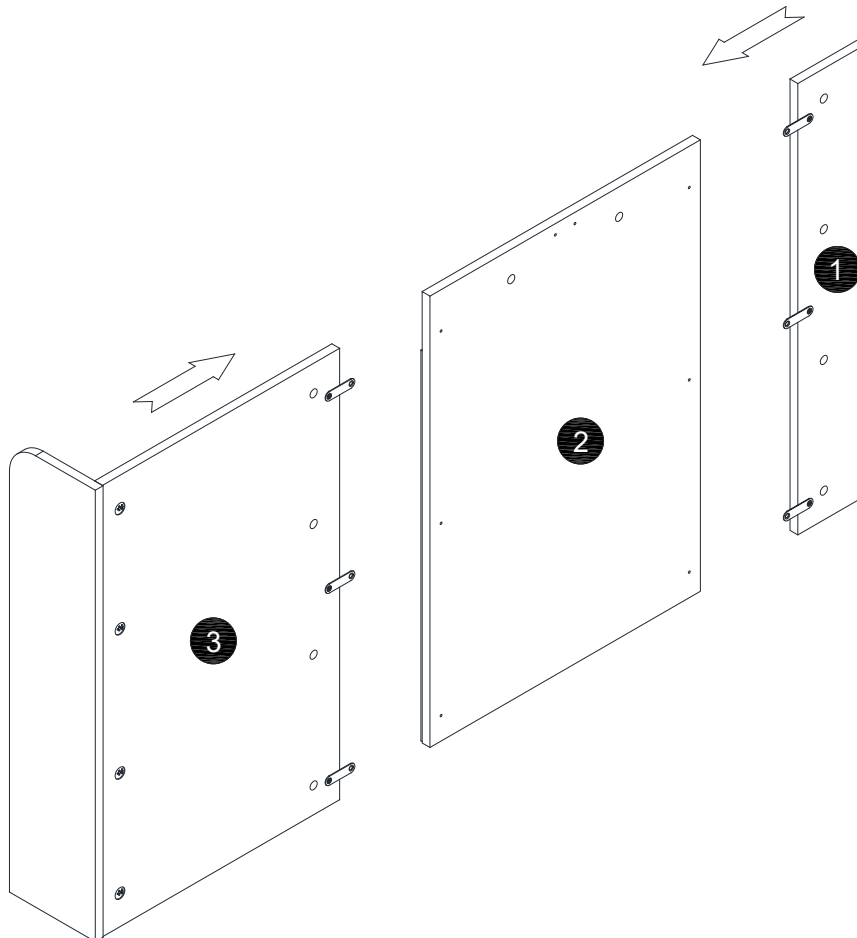

STEP 7

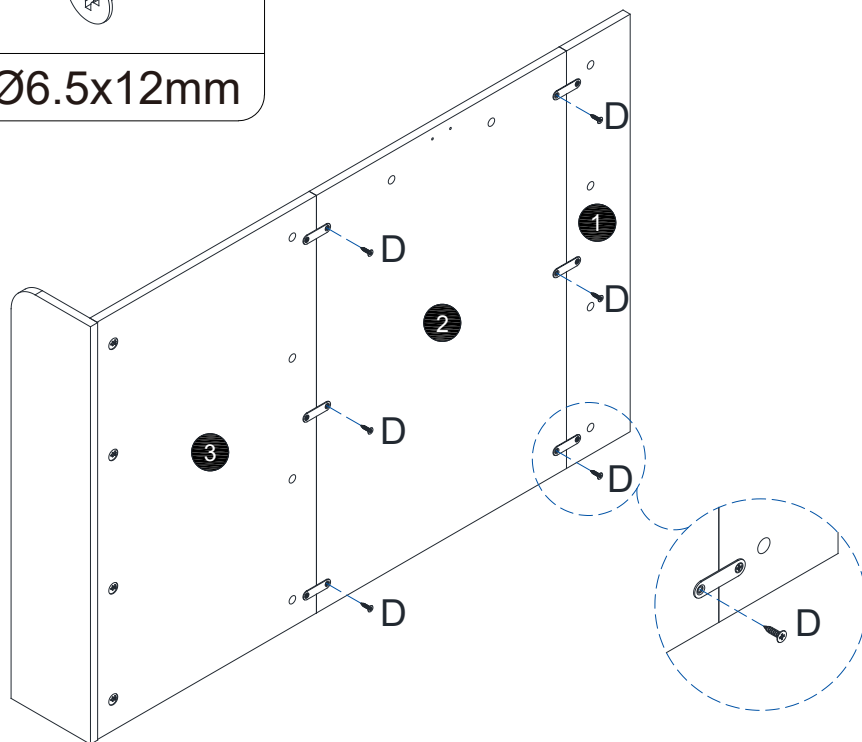
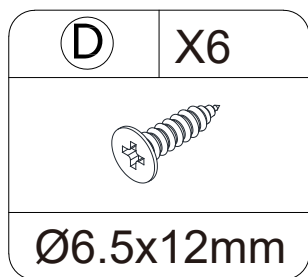
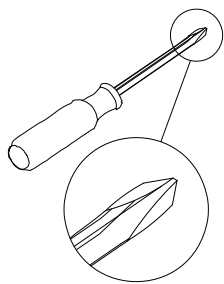

STEP 8

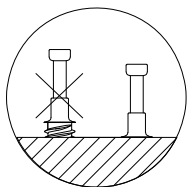
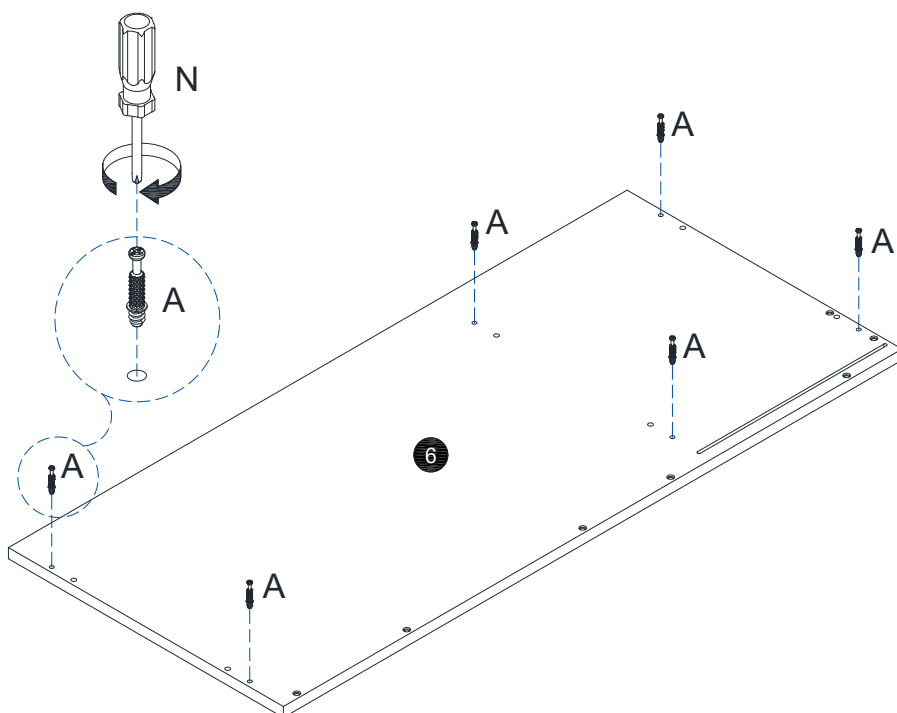
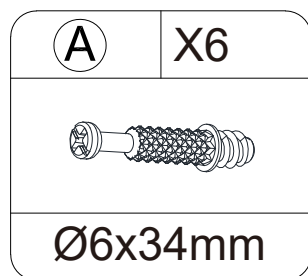
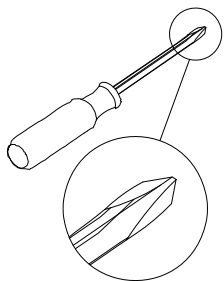

STEP 9

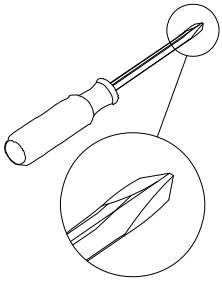

(C)	X3
Ø6*30mm	

(E)	X7
Ø8*35mm	

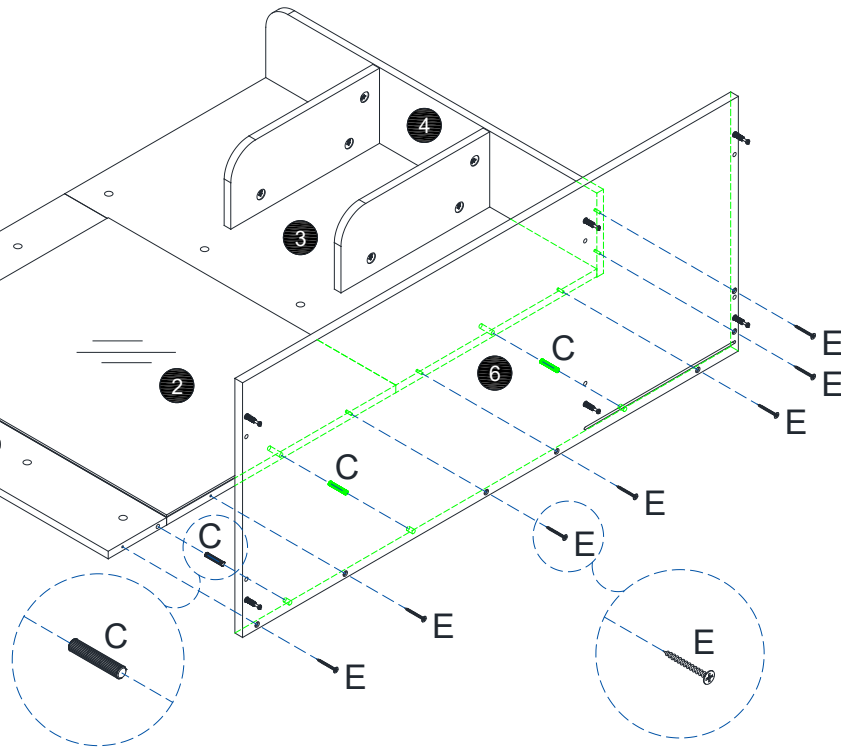

STEP 10

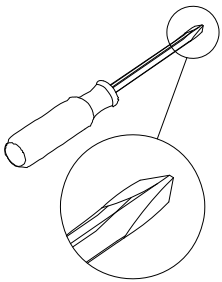

(A)	X6
Ø6x34mm	

(M)	X2
Ø13x4mm	

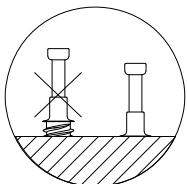
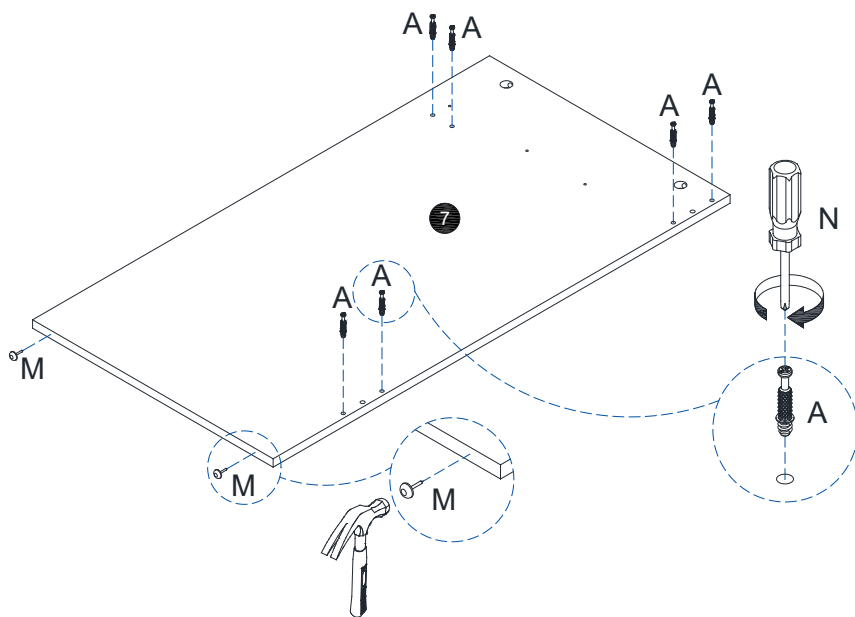

STEP 11

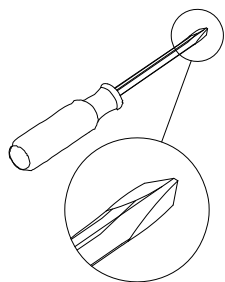

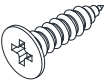
ⓓ	X3
	
Ø6.5x12mm	

ⓐ	X1
	
L=300	

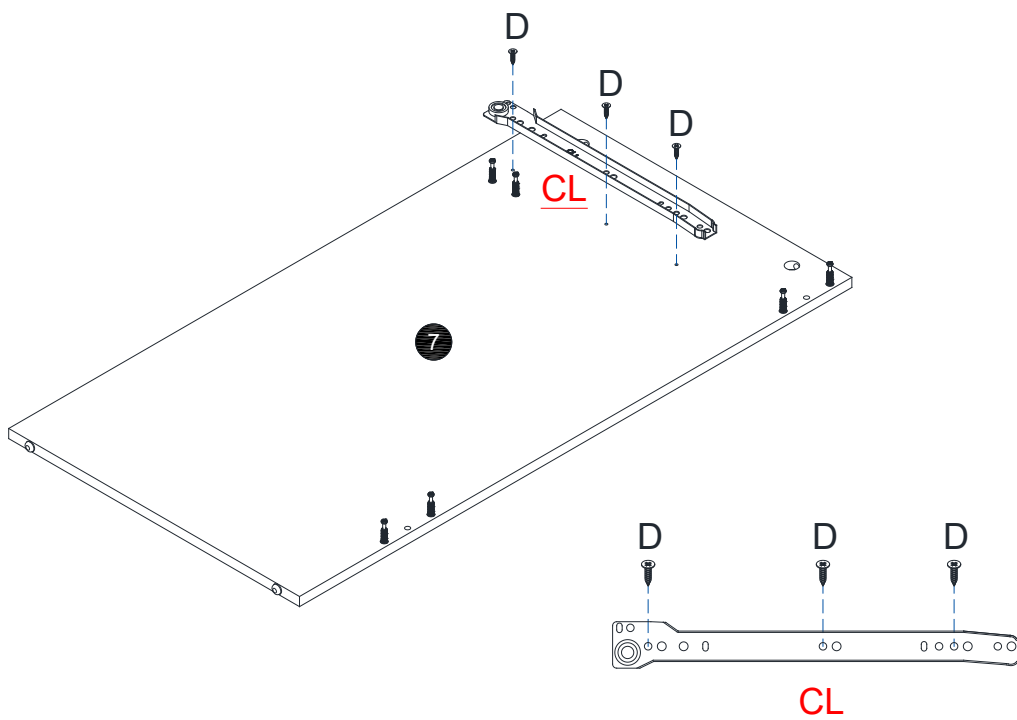

STEP 12

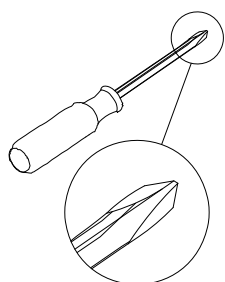

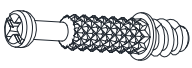
Ⓐ	X7
	
Ø6x34mm	

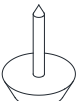
Ⓜ	X2
	
Ø13x4mm	

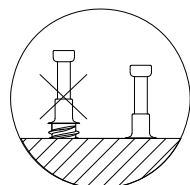
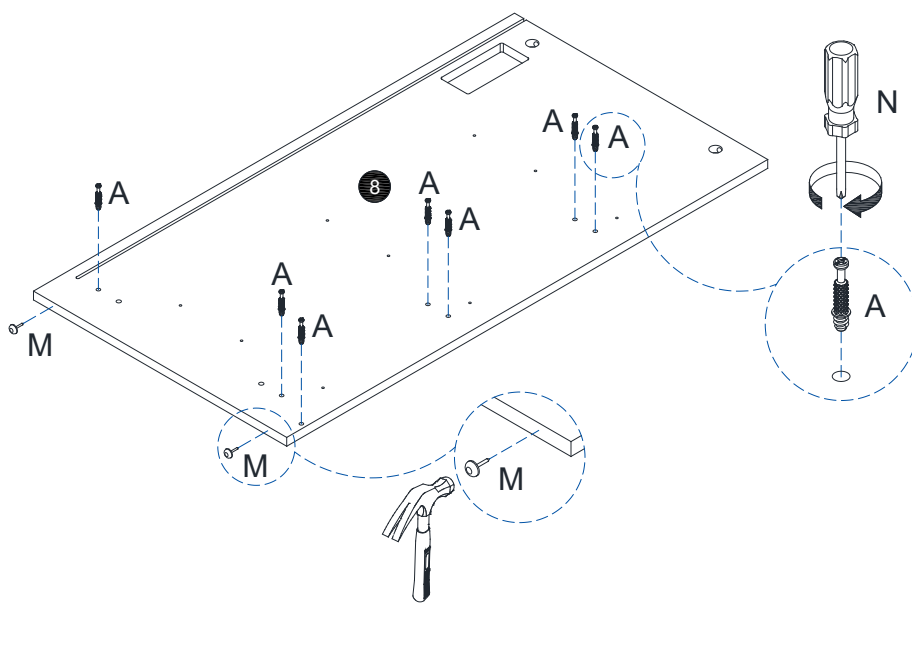

STEP 13

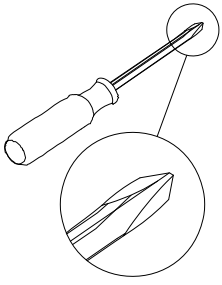

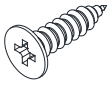
(D)	X9
	
Ø6.5x12mm	

(O)	X3
	
L=300	

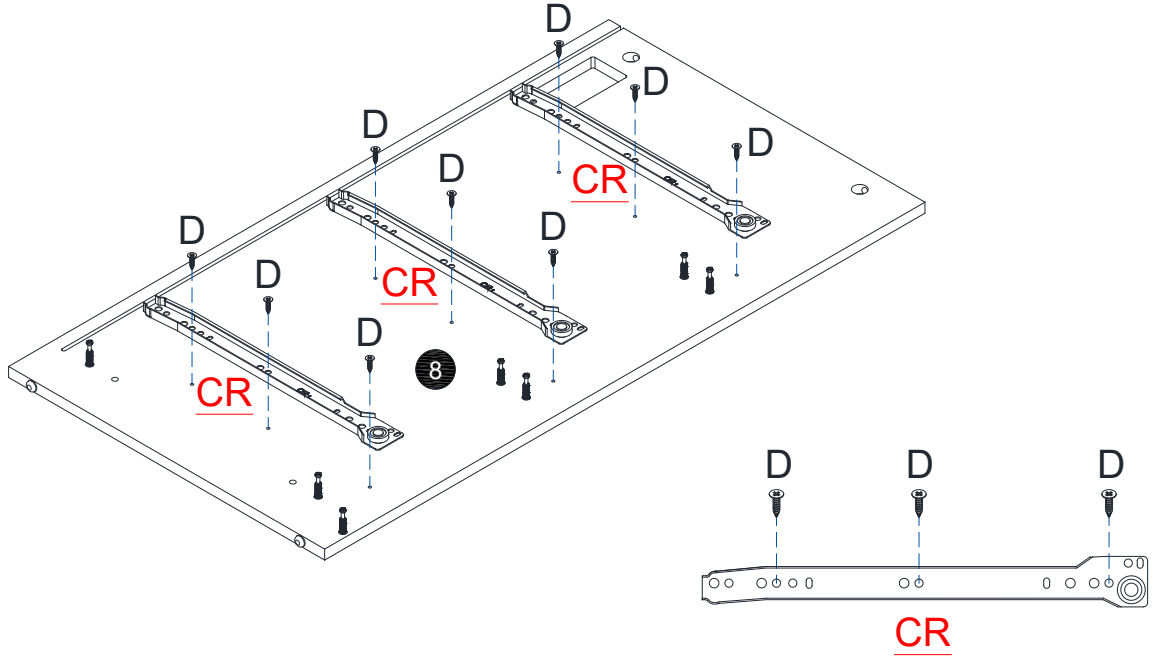

STEP 14

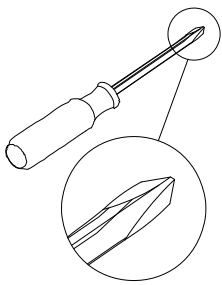

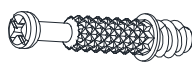
(A)	X7
	
Ø6x34mm	

(M)	X2
	
Ø13x4mm	

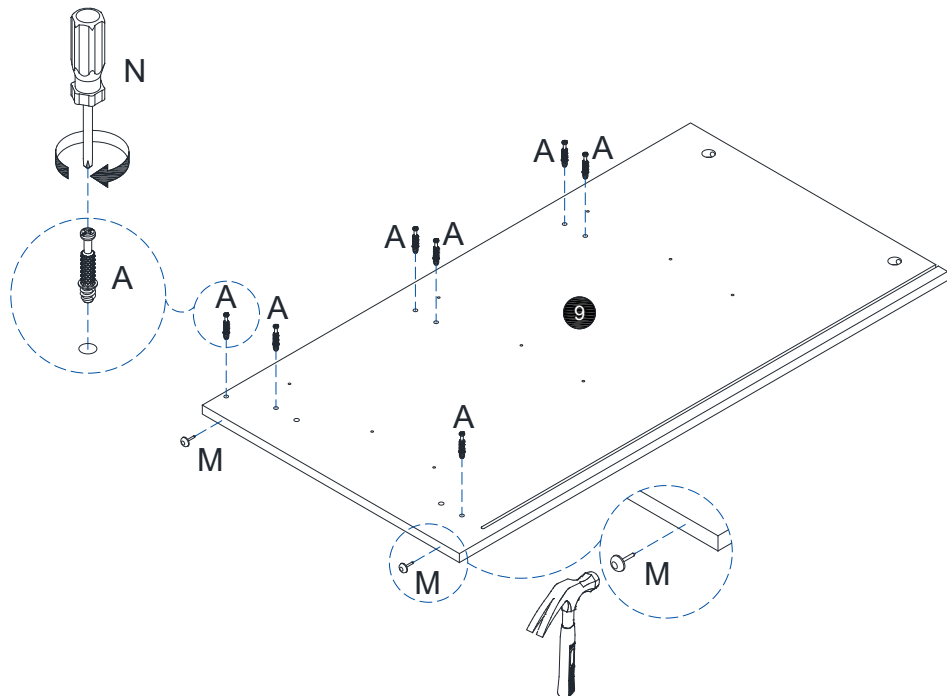

STEP 15

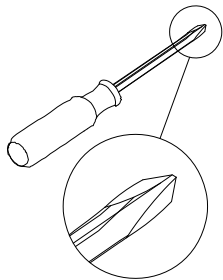

(D)	X9
Ø6.5x12mm	

(O)	X3
L=300	

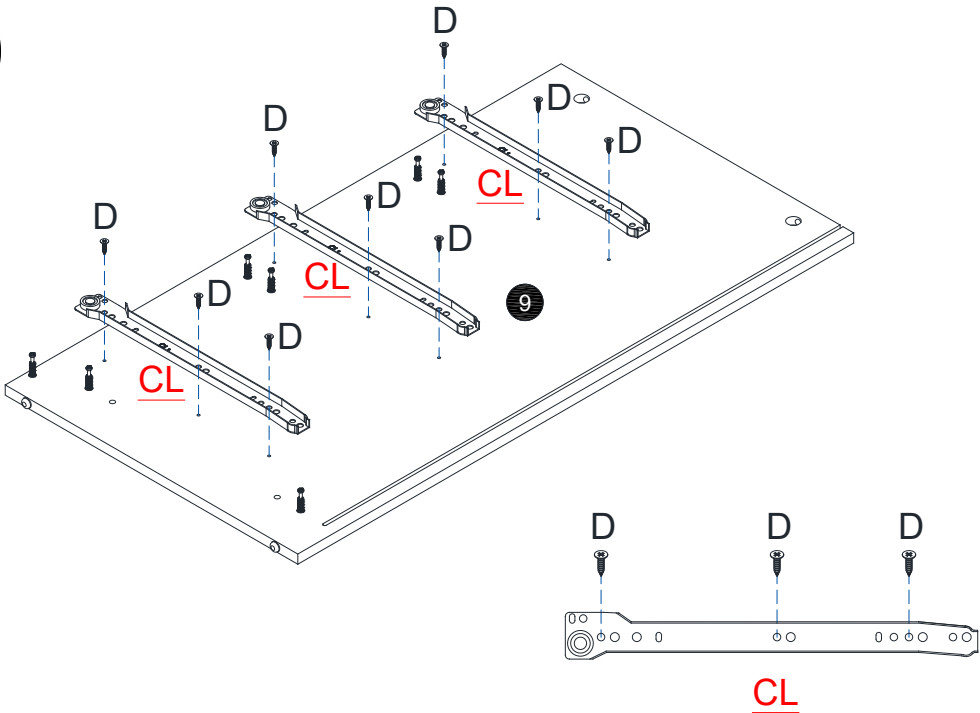

STEP 16

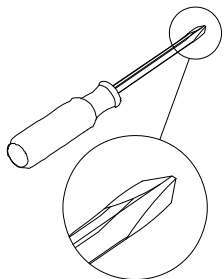

(A)	X6
Ø6x34mm	

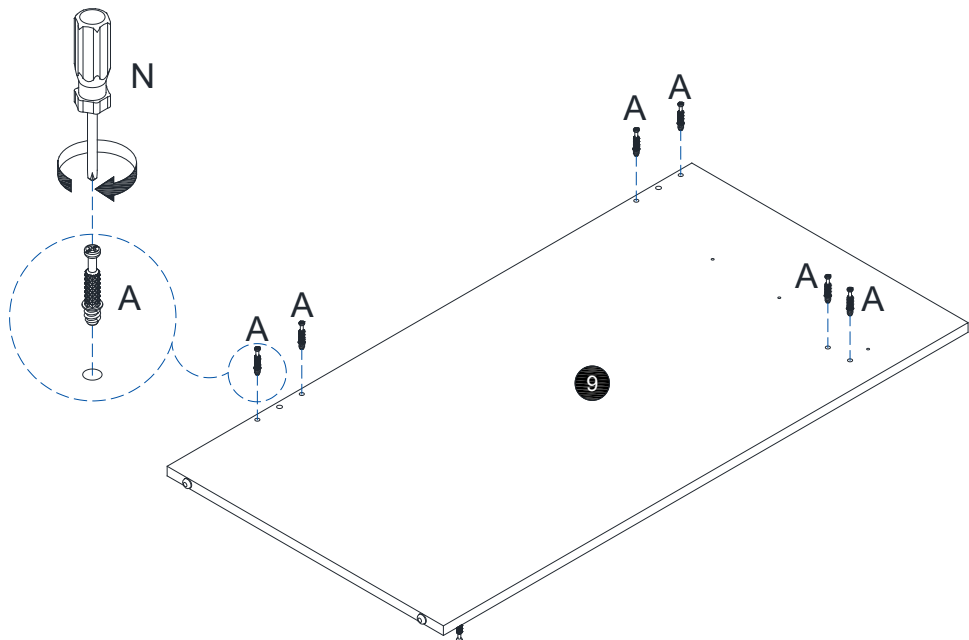

STEP 17

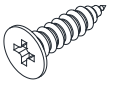
(D)	X3
	
Ø6.5x12mm	

(O)	X1
	
L=300	

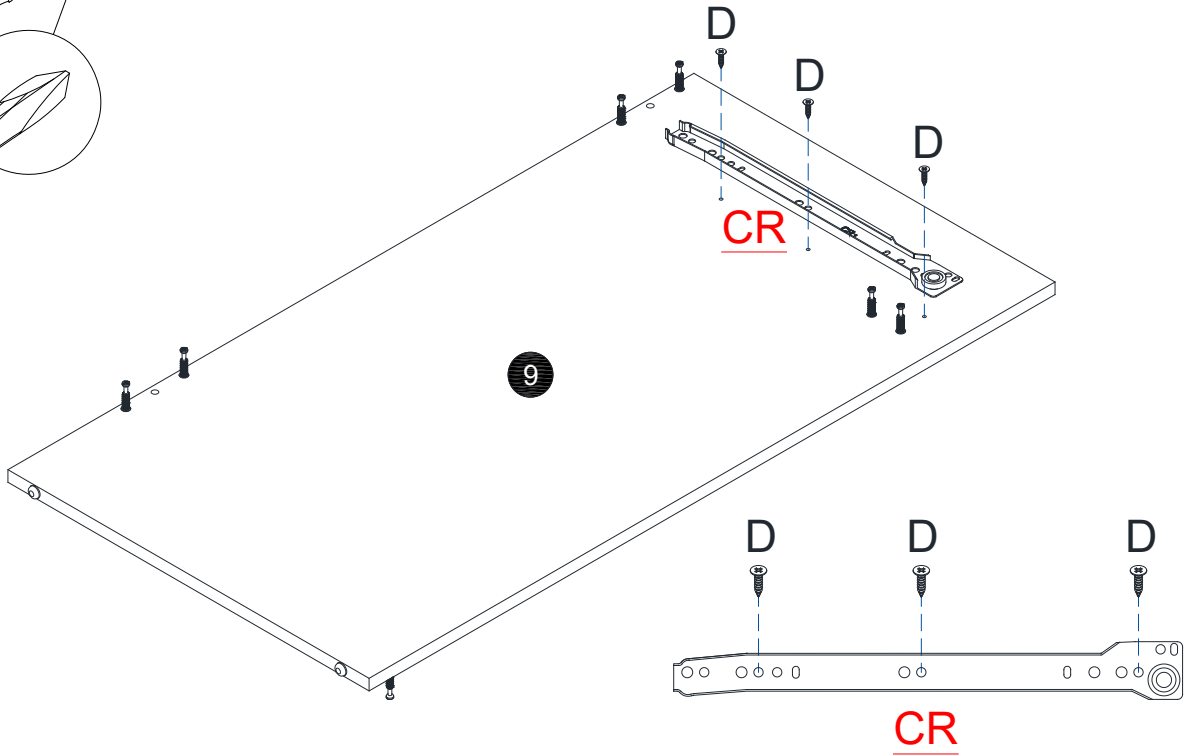
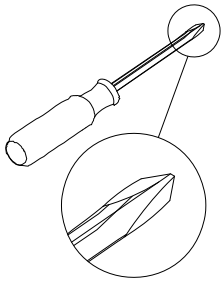

STEP 18

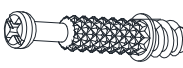
(A)	X2
	
Ø6x34mm	

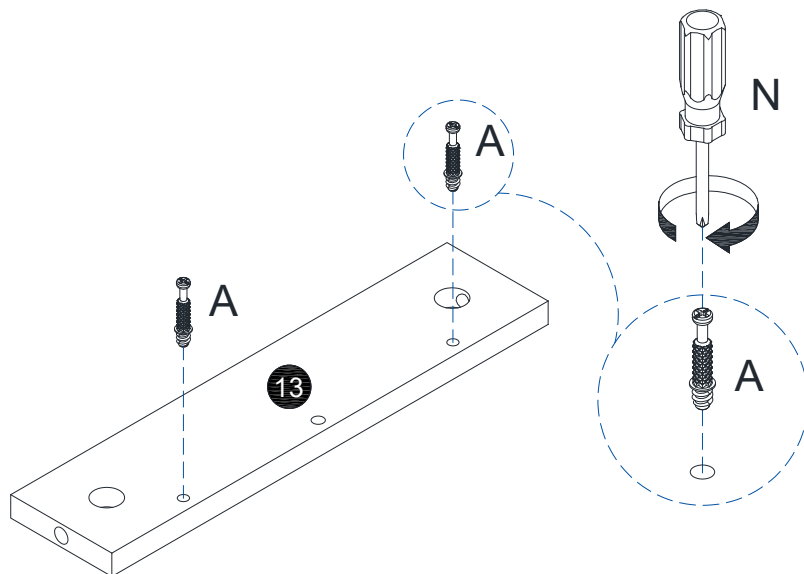
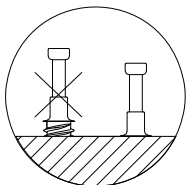
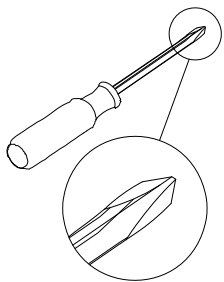

STEP 19

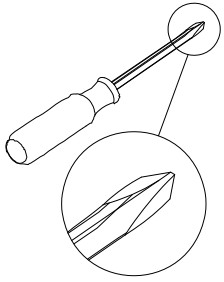
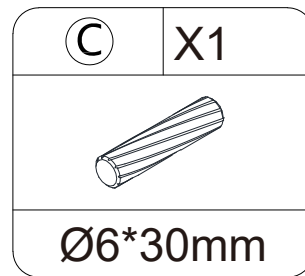
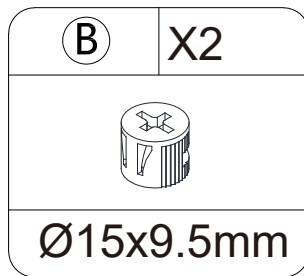

Insert the cam bolt into the hole first, then insert the cam lock and lock it.

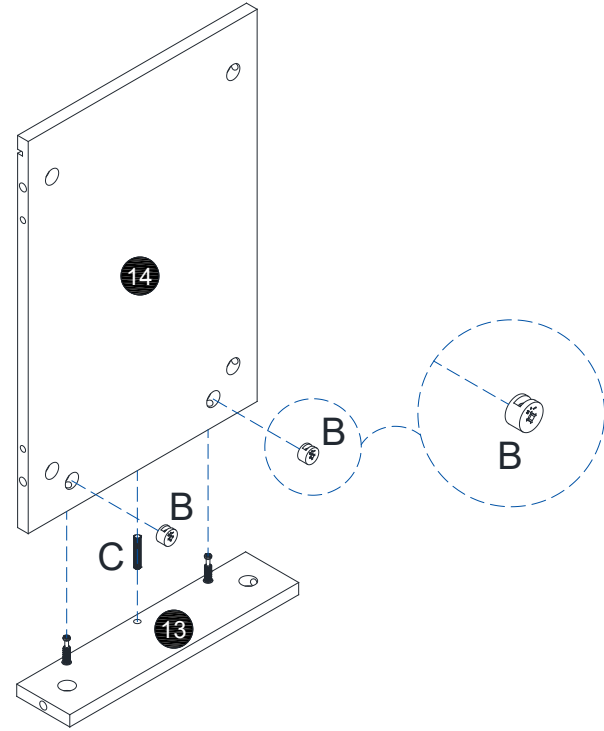
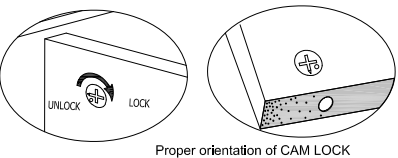

STEP 20

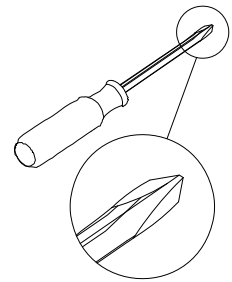
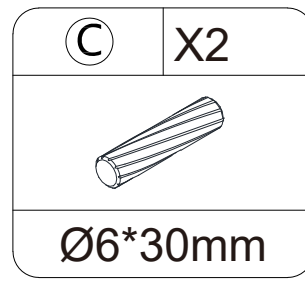
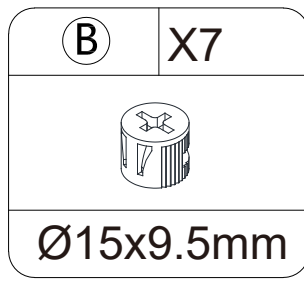

Insert the cam bolt into the hole first, then insert the cam lock and lock it.

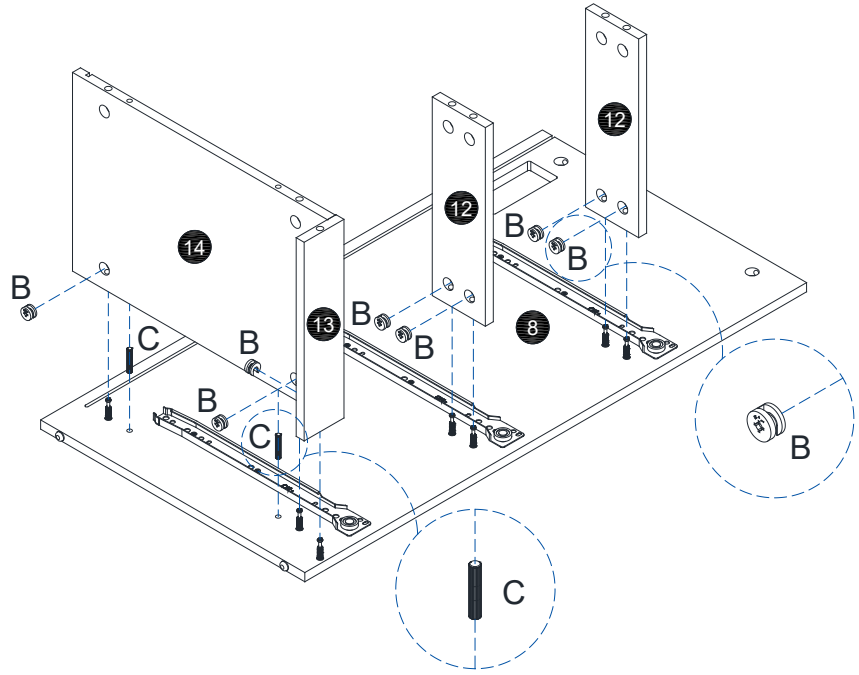
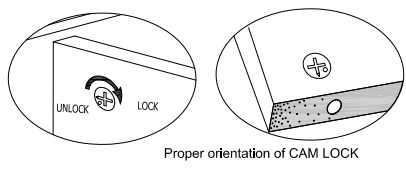

STEP 21

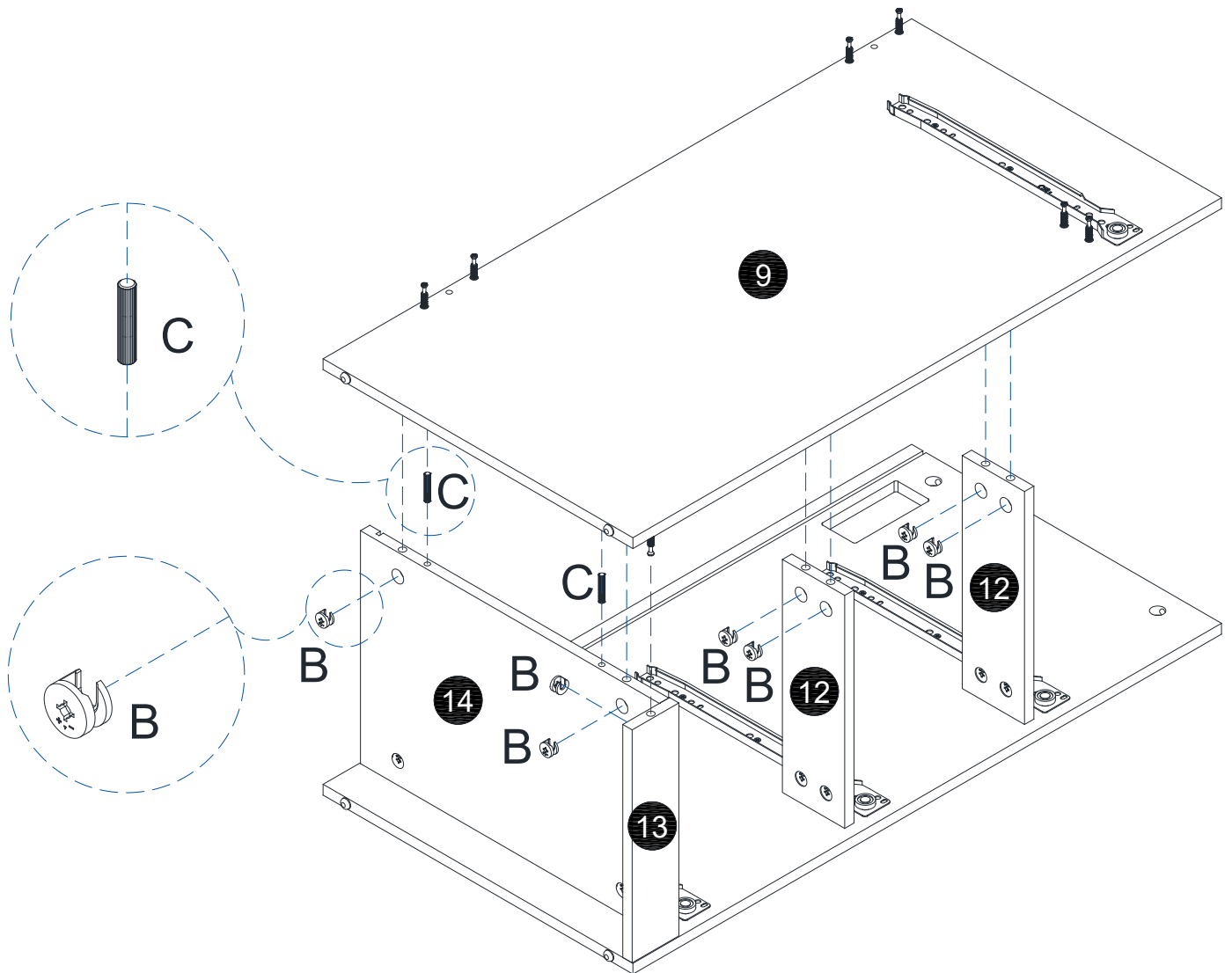
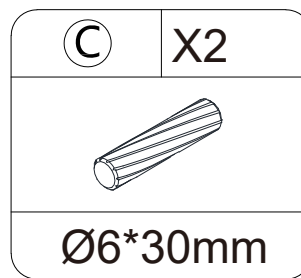
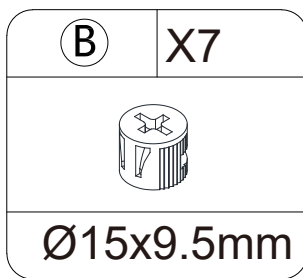
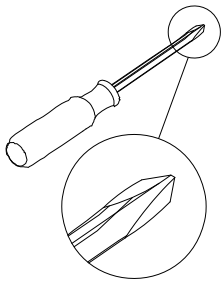

Insert the cam bolt into the hole first, then insert the cam lock and lock it.

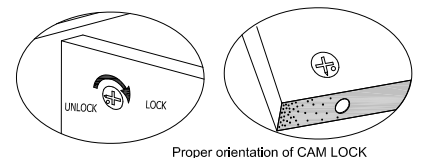

STEP 22

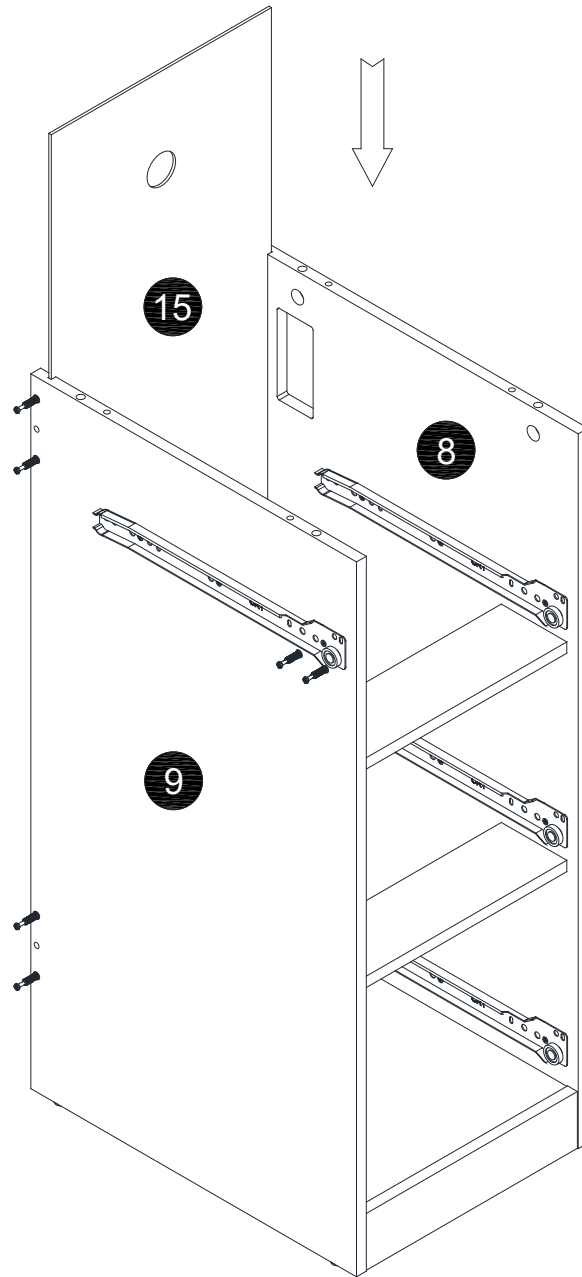

STEP 23

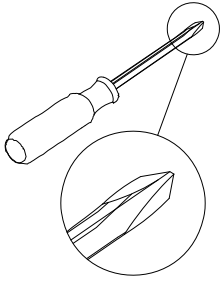
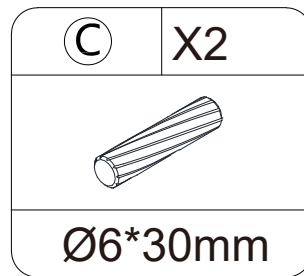
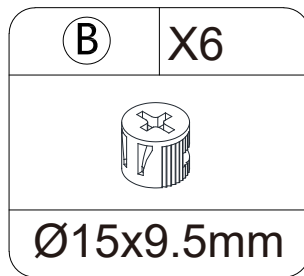

Insert the cam bolt into the hole first, then insert the cam lock and lock it.

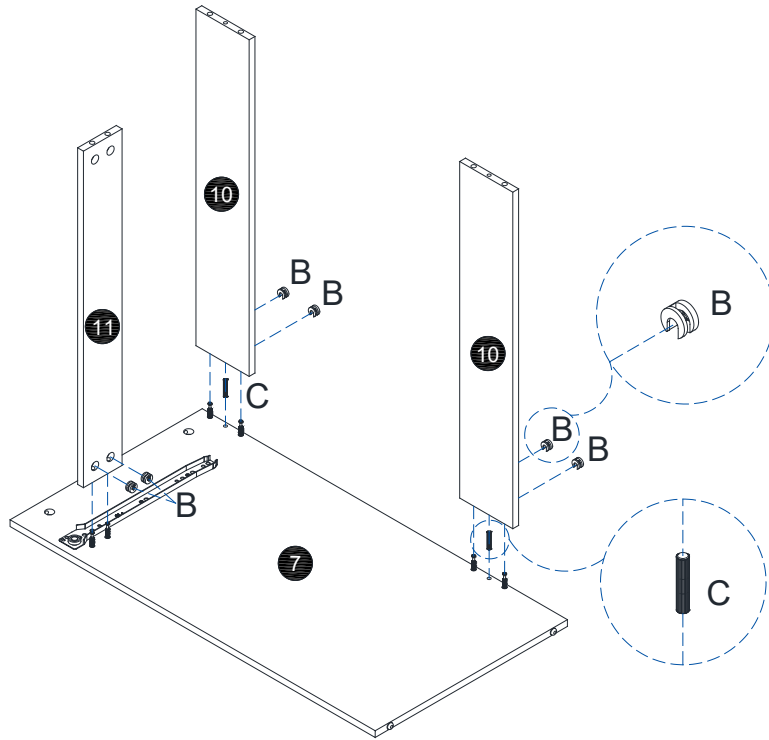
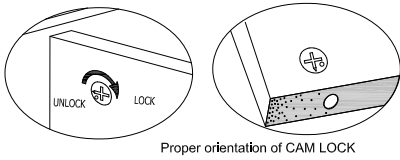

STEP 24

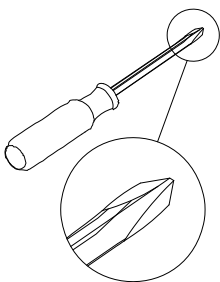
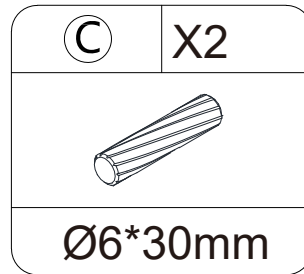
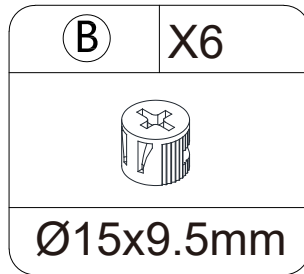

Insert the cam bolt into the hole first, then insert the cam lock and lock it.

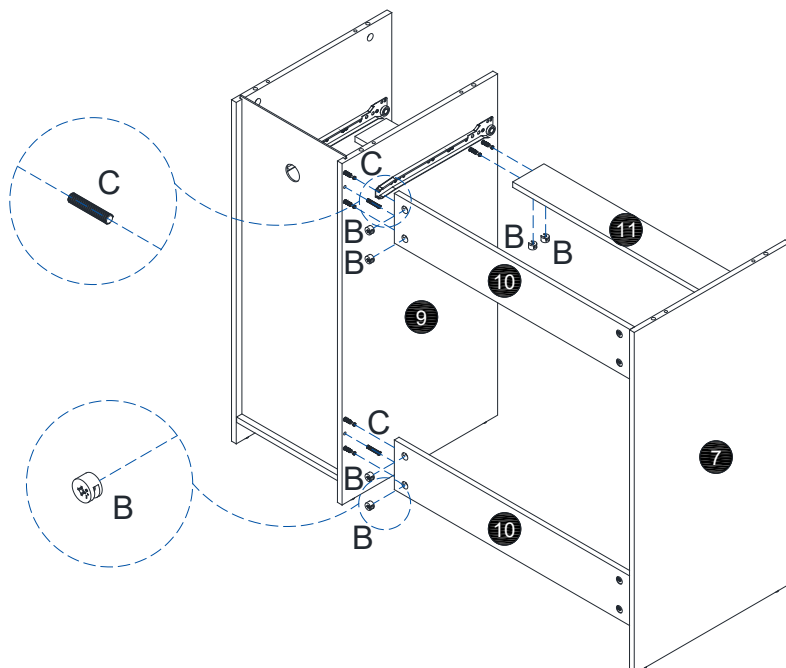
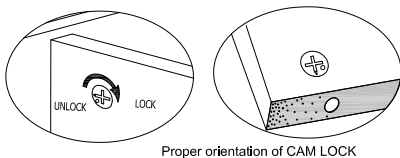

STEP 25

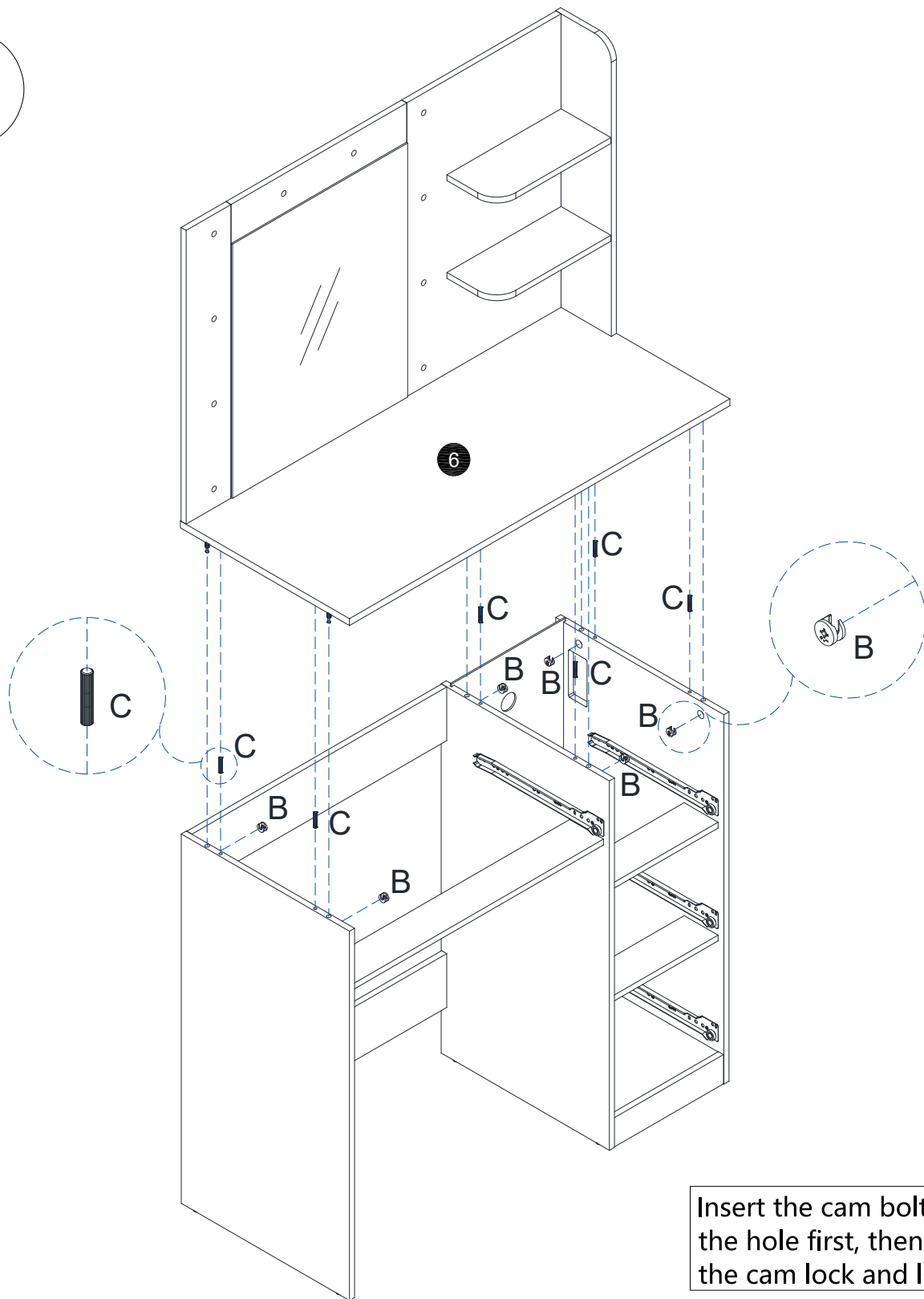
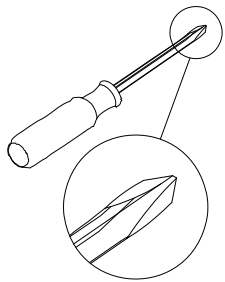
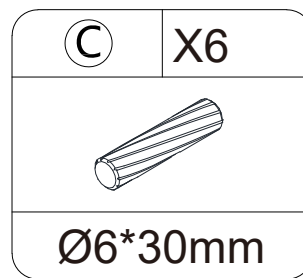
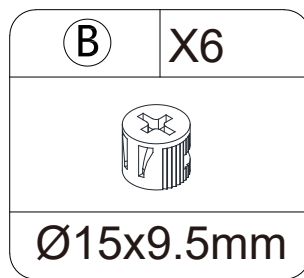

Insert the cam bolt into the hole first, then insert the cam lock and lock it.

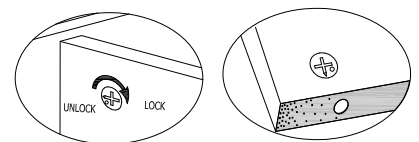

STEP 26

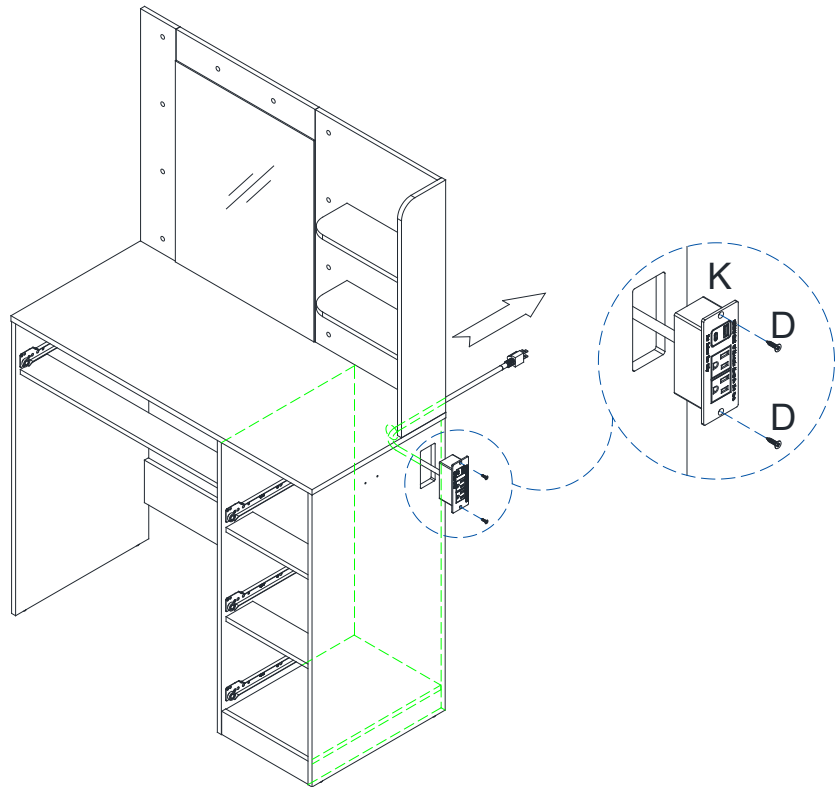
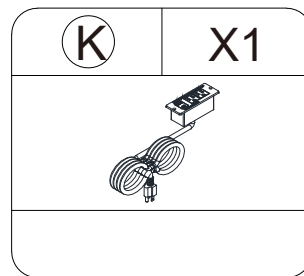
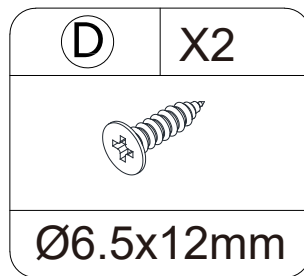
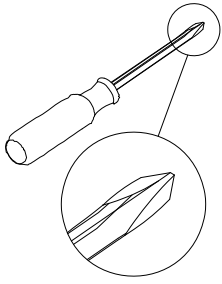

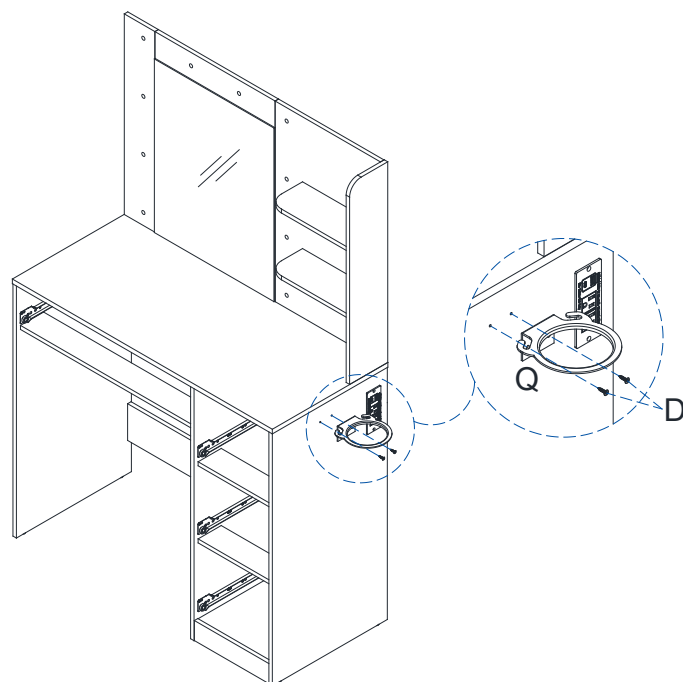
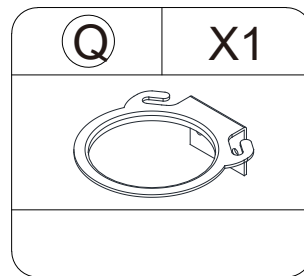
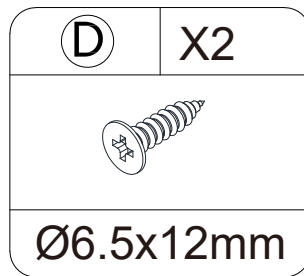
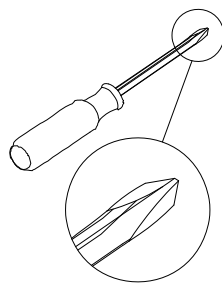

STEP 27

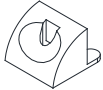

STEP 28

(F)	X4
	
Ø3x15mm	

(G)	X4
	

(L1)	X1
	

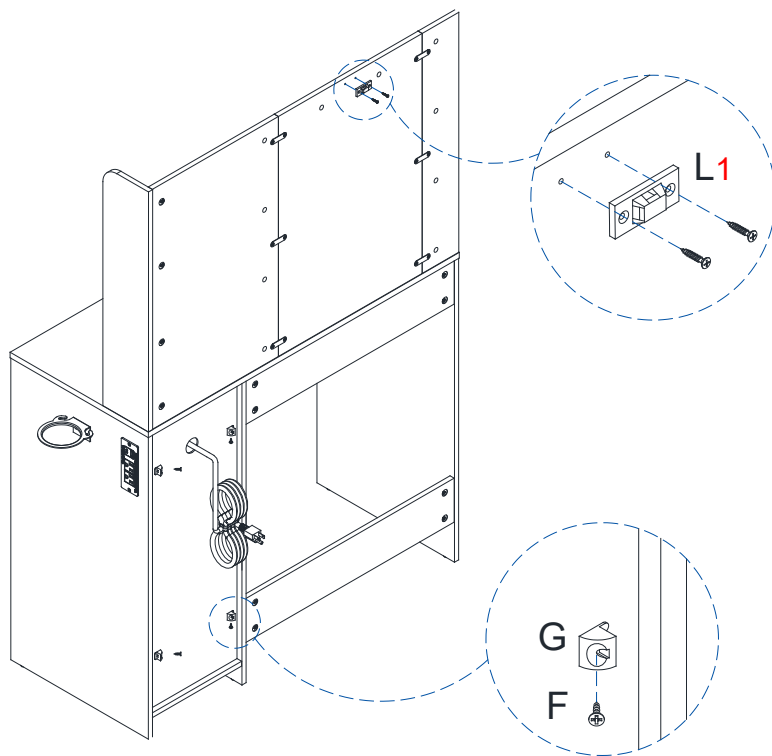
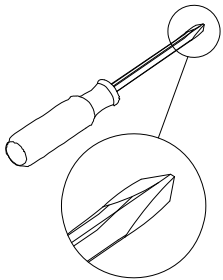

STEP 29

(A)	X18
	
Ø6x34mm	

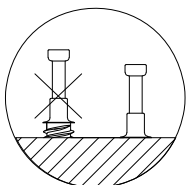
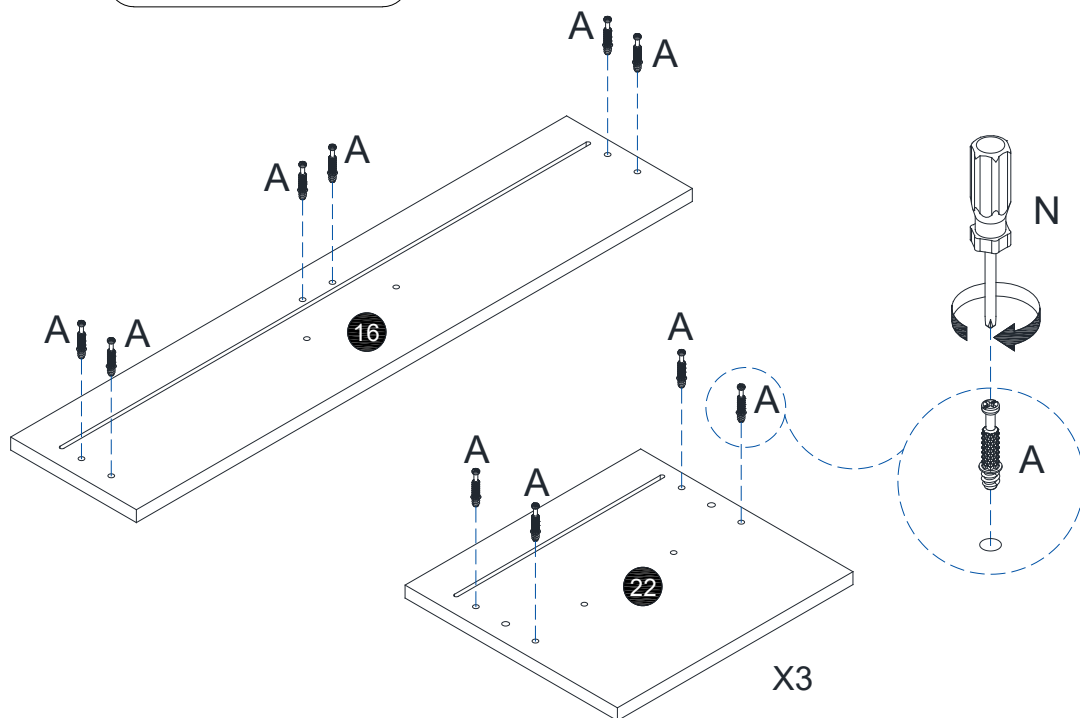
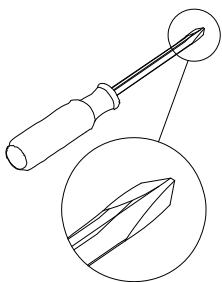

STEP 30

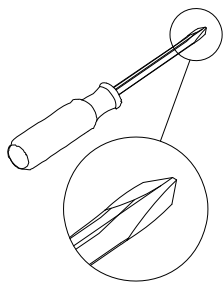

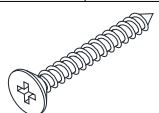
(E)	X16
	
Ø8*35mm	

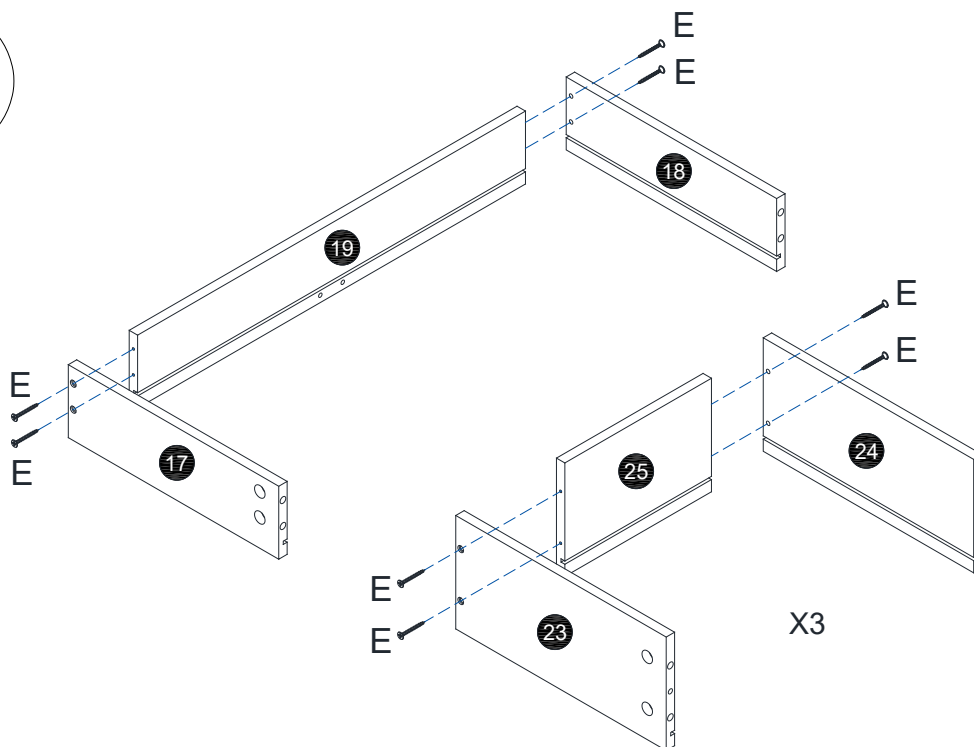

STEP 31

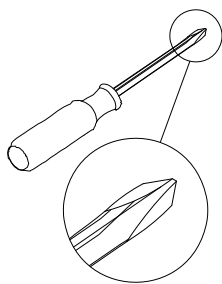

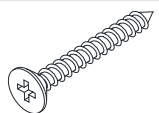
(E)	X2
	
Ø8*35mm	

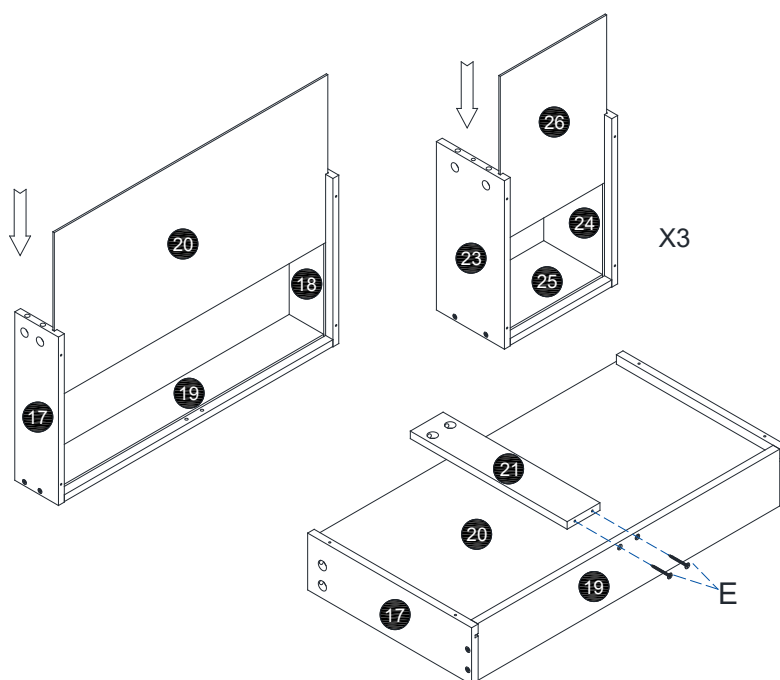

STEP 32

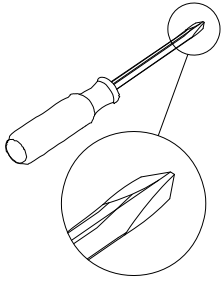
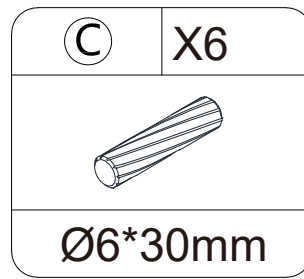
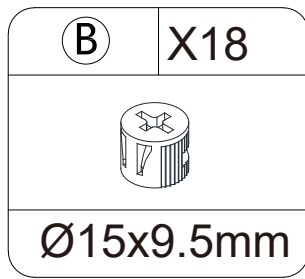

Insert the cam bolt into the hole first, then insert the cam lock and lock it.

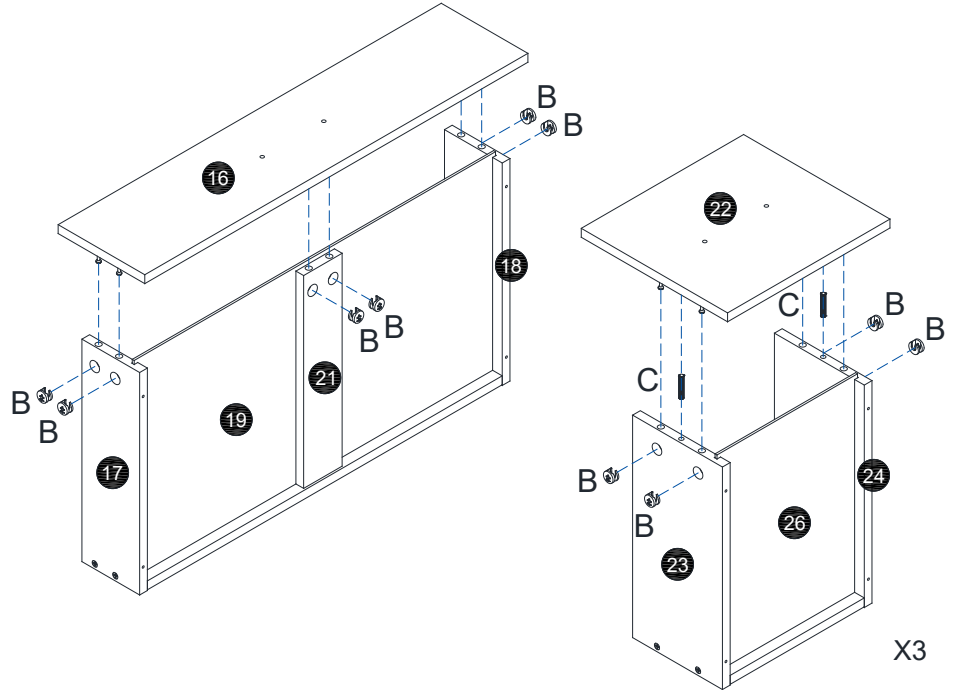
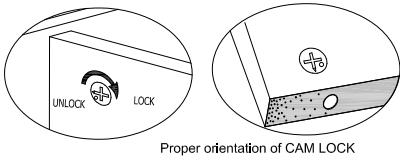

STEP 33

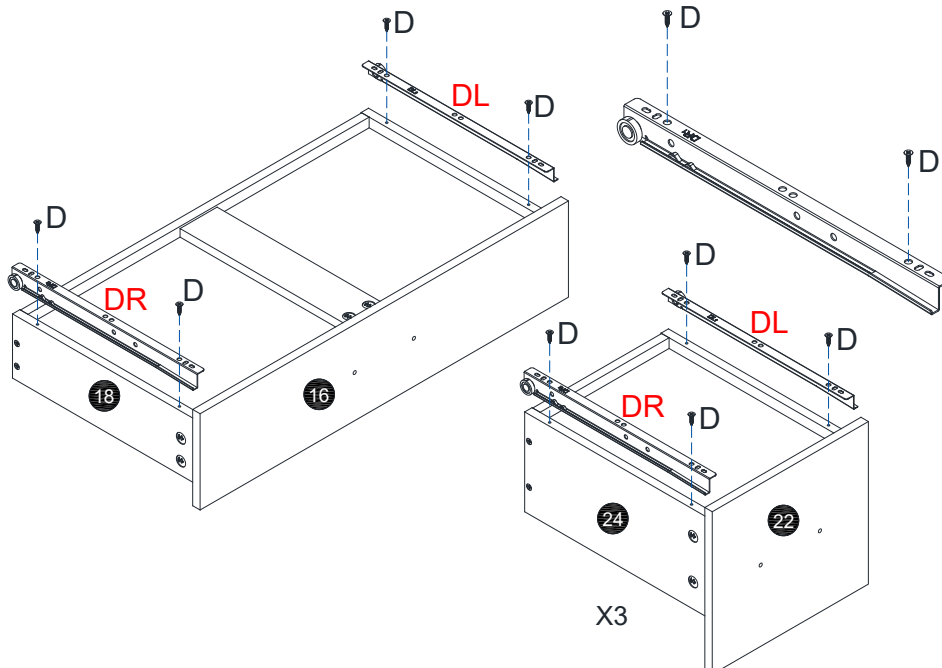
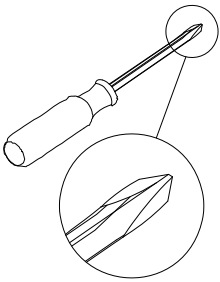
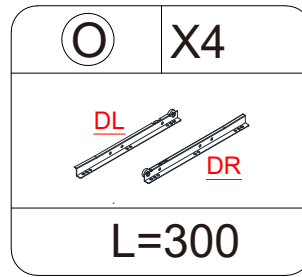
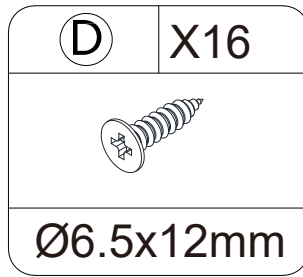

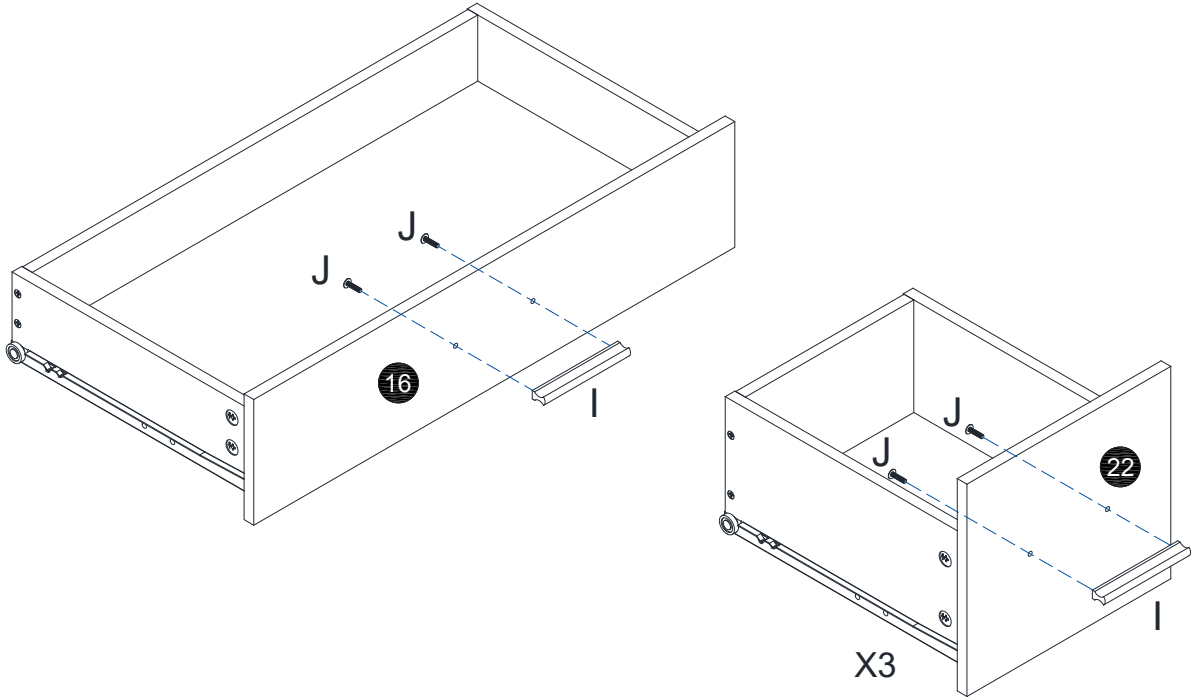
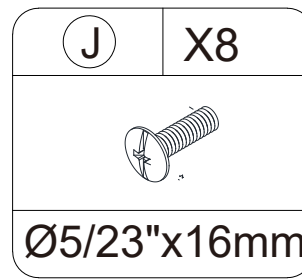
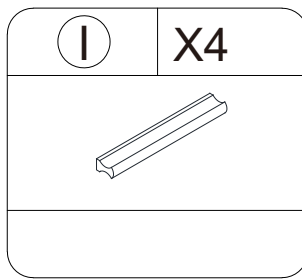
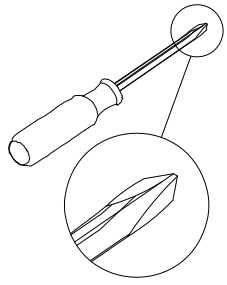

STEP 34

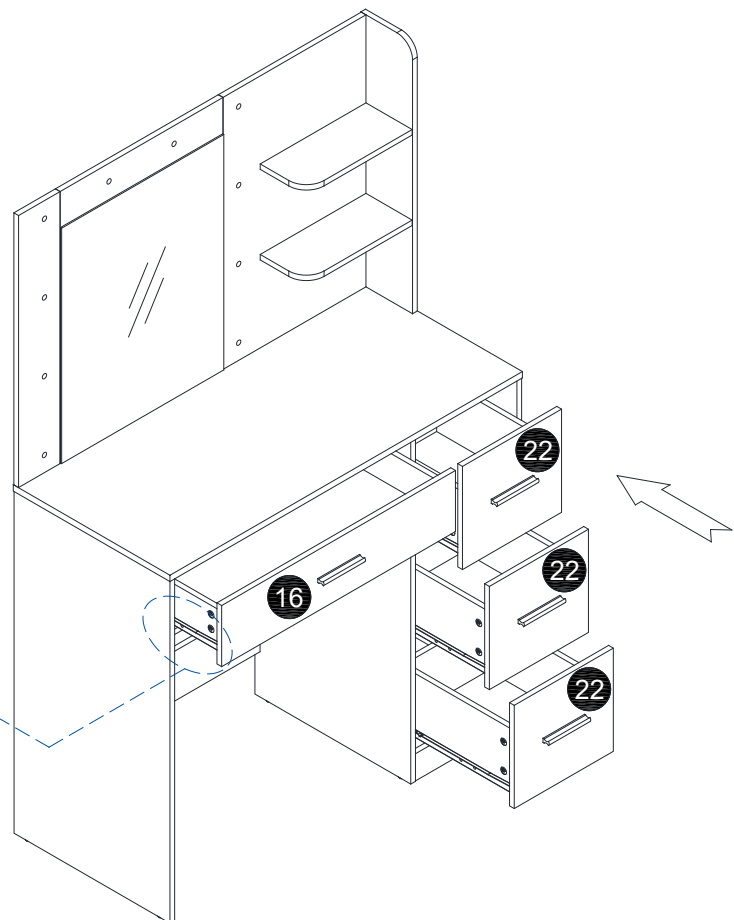
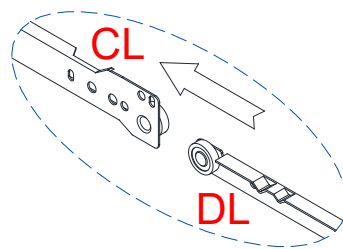
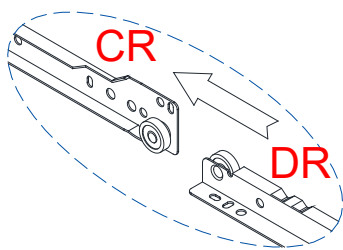

STEP 35



STEP 36

(P)	X1 set
	10PCS
	1PC

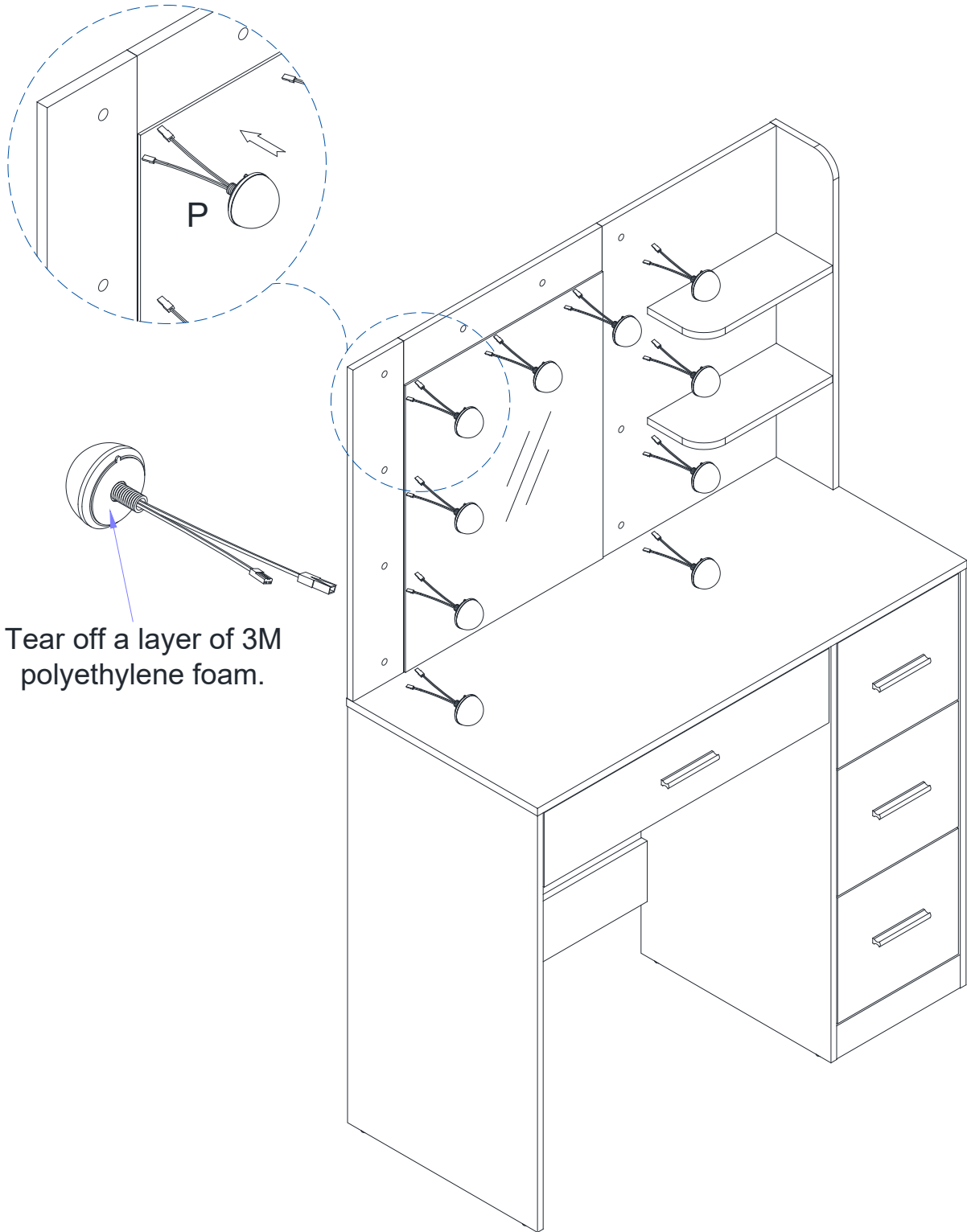

Tear off a layer of 3M polyethylene foam.

STEP 37

Pass the bulb wire through the pre punched plate, then gently press the bulb and make it adhere to the plate, and then connect the adjacent bulbs successively through the wire head slot on the opposite (corresponding to the line of the same color)

When connecting the interface, please note that the colors of the wires at both ends correspond one by one.

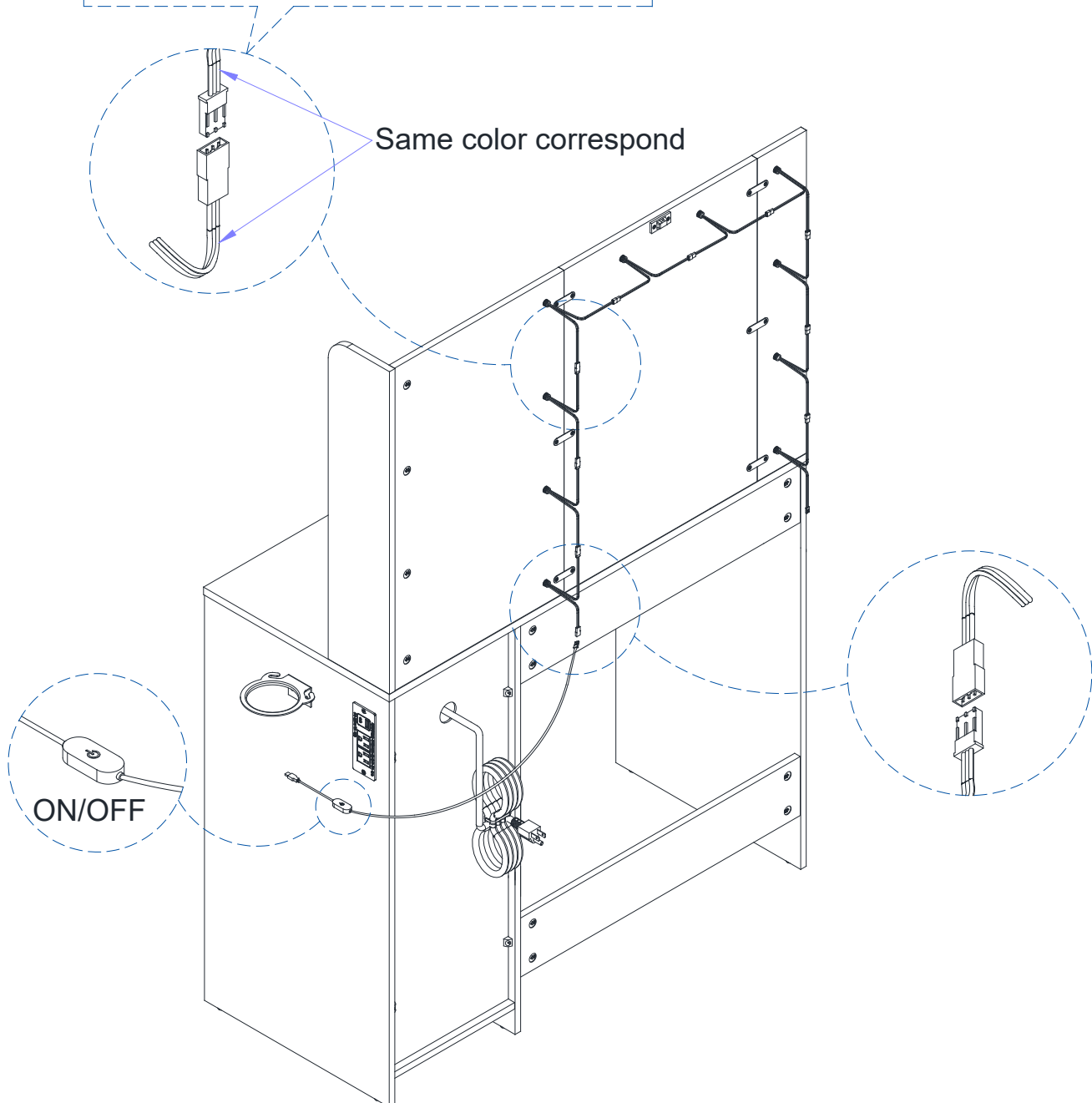

STEP 38

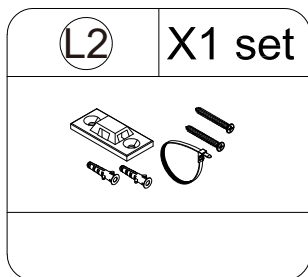

Install the tipping restraint hardware

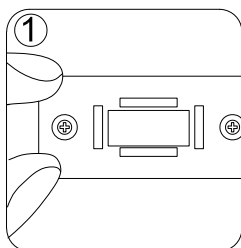

1. make mark on the wall

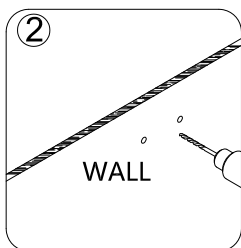

2. drill two $\varnothing 6$ holes on the wall

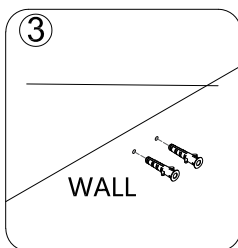

3. put two anchors in the holes

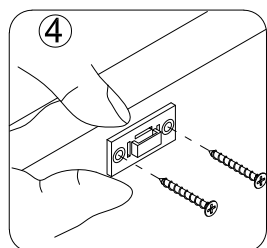

4. fix the device on the wall by the long screws

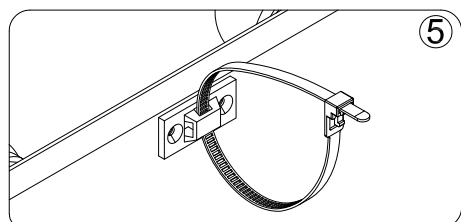

5. Push the cabinet close to the wall so that the two bases are close to each other, and then put on nylon tie to tighten it.

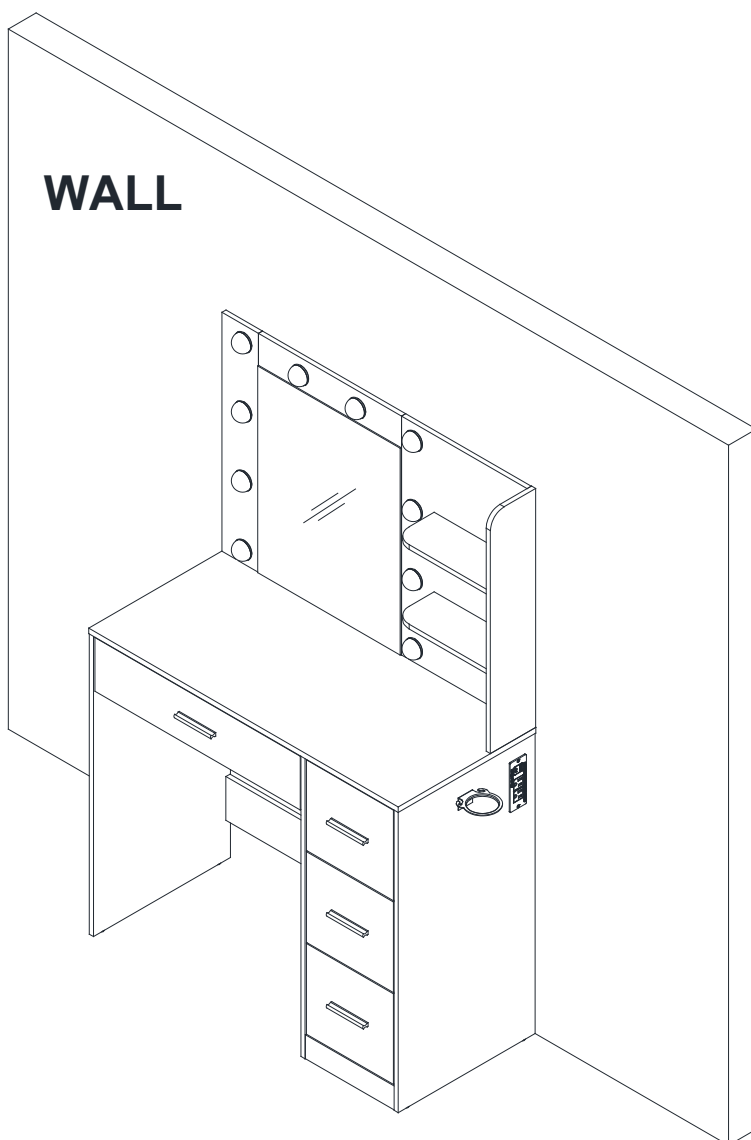

FURNITURE CARE AND MAINTENANCE

Thank you for your purchase. We want your item to last as long as possible. To ensure the product gives you years of service, please refer to this care and maintenance guide.



MAINTENANCE

Tighten all bolts and screws again within the first 2 weeks of assembly
Check the tightness of all bolts every 2 months, tighten them if necessary



CLEANING

Clean the surface of the MDF and PB (medium - density fiberboard) with a lightly dampened cloth.

Small amount of mild soap can be used if necessary

- Dry the surface immediately after cleaning.

⚠ DO NOT use bleach or alcohol detergent to clean the surface.

⚠ DO NOT apply wood treatment on parts made with MDF/PB.

Medium - density fiberboard and PB will swell and distort when suffer from water damage.
Make sure to dry the furniture immediately after cleaning