

# 2-TIER SOLAR WATER FOUNTAIN

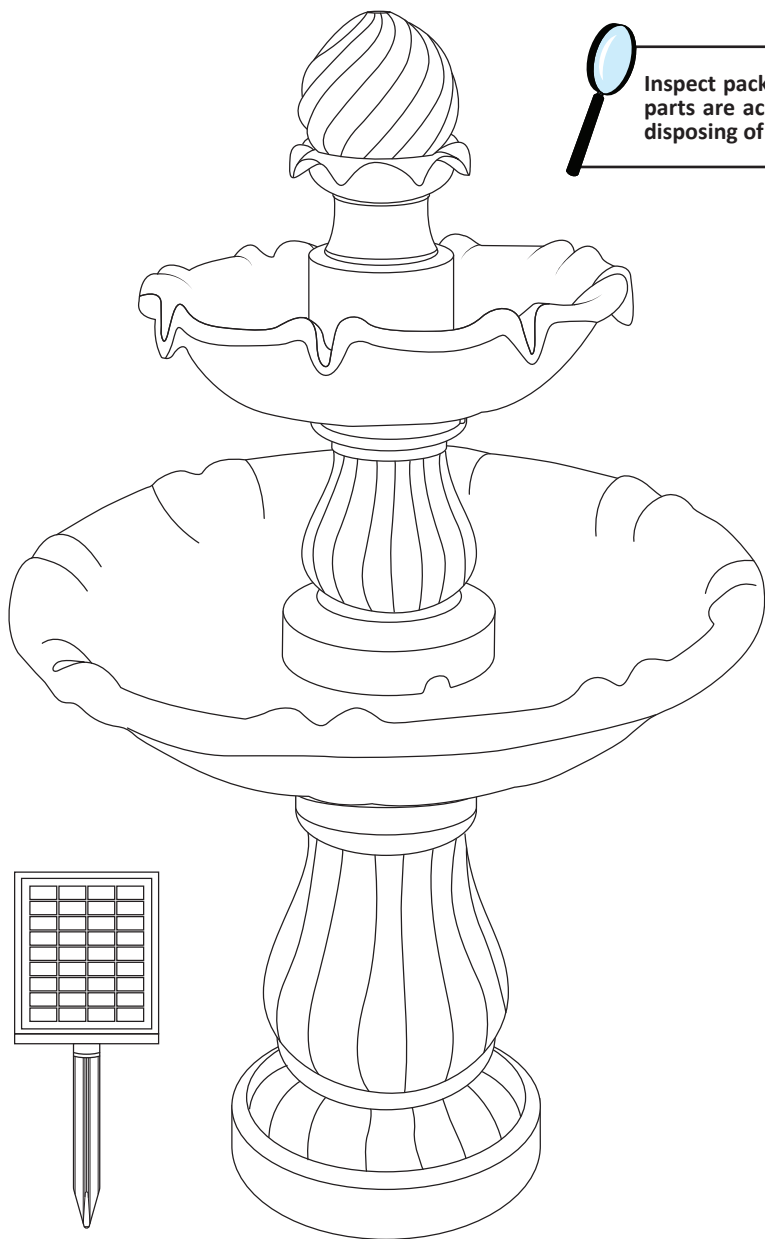



Review all assembly and care information before using this product. Save this manual for future reference.

Select a smooth, level surface to place the fountain.

Assemble components on a soft, clean surface to avoid scratching or damaging the finish.

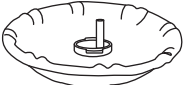
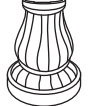

Inspect packaging to ensure all parts are accounted for before disposing of packing materials.

PARTS		QTY.
	Topper	1
	Top Bowl	1
	Column	1
	Bottom Bowl	1
	Pedestal	1
	Solar Pump & Panel Kit	1



## IMPORTANT NOTES:

- The water tubing is built into the fountain topper. Take care when handling the water tube; detaching the water tube from the fountain will damage the unit and void the warranty.
- Rattling noise inside the fountain? Due to the casting process, there may be loose pieces of casting material inside the fountain.
- The solar panel kit may include accessories (extension tubes, spray heads, LED light ring) that are not required for operation of this fountain. Refer to *ASSEMBLY*, page 2, for required components.

## WARNING:

Manufacturer and seller expressly disclaim any and all liability from personal injury, property damage or loss, whether direct or indirect, or incidental, resulting from the incorrect attachment, improper use, inadequate maintenance, or neglect of this product.

# ASSEMBLY

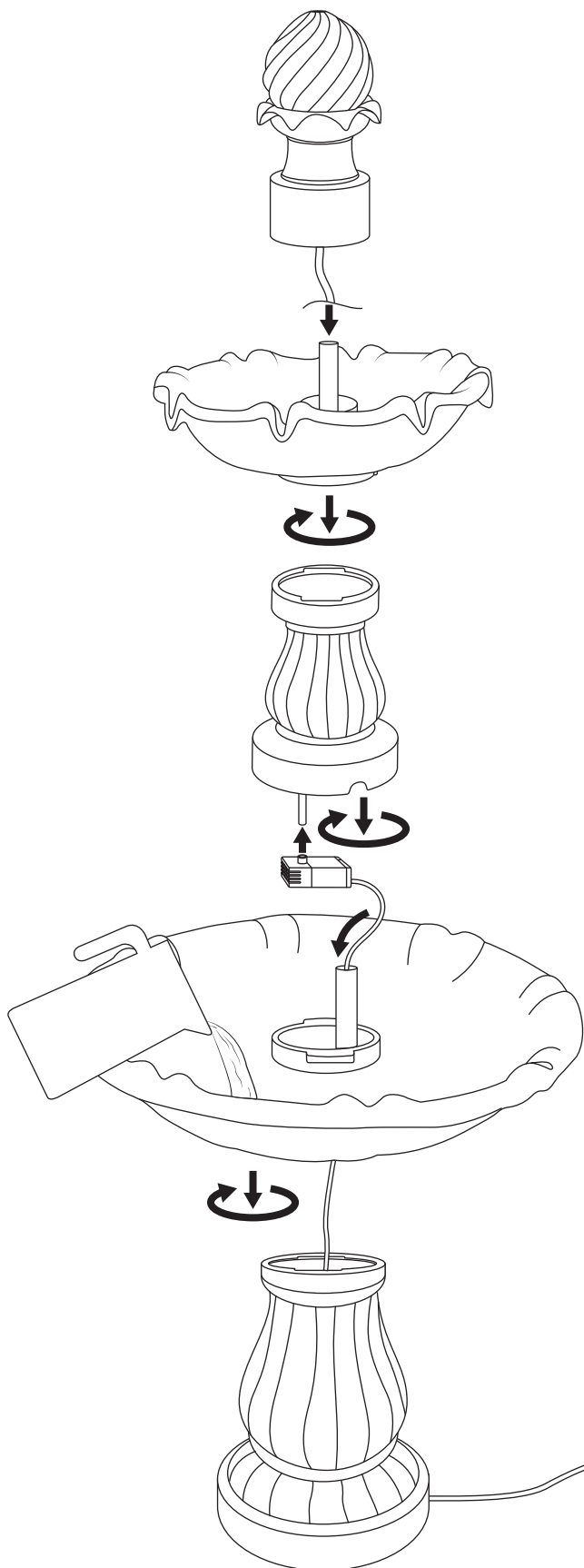

1. Place the bottom bowl onto the pedestal and twist to lock in place.
2. Place the pump in the center of the bottom bowl. Run the power cable through the pipe in the bowl and beneath the groove in the bottom of the pedestal.
3. Place the top bowl onto the column and twist to lock in place.
4. Run the water tube that is built into the topper through the top bowl and column.
5. Taking care not to drop the topper, firmly connect the water tube to the pump.
6. Ensuring the pump is sitting flat inside the bottom bowl, align the column with the bottom bowl, twist to lock in place.
7. Fill each tier with enough water to keep the pump fully submerged during operation.
8. Assemble the stake and attach the solar panel.
9. Connect the solar panel cable to the pump and tighten the nuts.
10. Press the switch on the back of the panel to turn on the power.

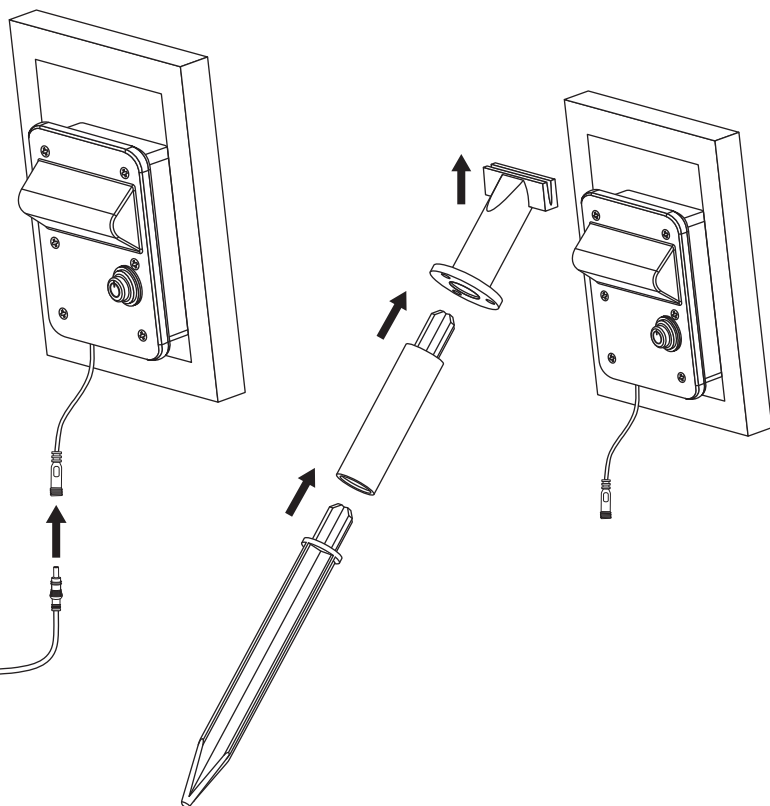

## PANEL PLACEMENT

Insert the spike into the ground. Position the solar panel to face south (in the Northern Hemisphere) to make the most of daylight hours. It is important to angle the solar panel towards the sun when the sun is at its highest point. Ensure trees, shrubs, or buildings do not shade the solar panel.

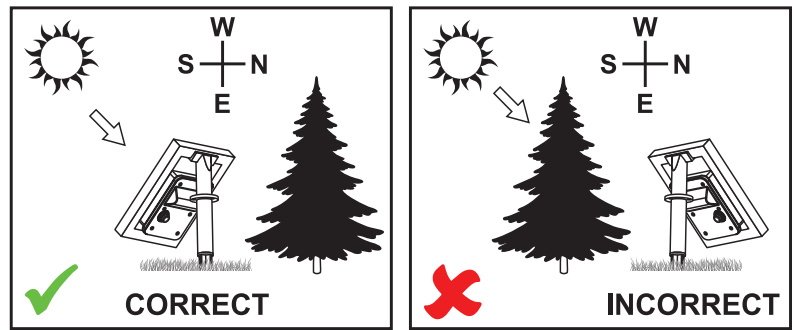





## SOLAR PANEL OPERATION

Press the ON/OFF switch on the back of the solar panel to turn the fountain on. The pump will automatically operate when there is sufficient sunlight. Excess solar energy is used to charge the built-in rechargeable lithium battery. When sunlight is reduced due to clouds, shade, or evening conditions, the pump will automatically draw power from the battery. Once the battery is depleted, the pump will stop operating. No additional button presses are required. The fountain will automatically restart when sufficient sunlight returns. To turn the fountain off, press the ON/OFF switch again. With a full charge, the pump will run for 3 hours under normal conditions.

## SOLAR PANEL STORAGE

Turn the solar panel OFF before storage. Clean and dry the fountain, pump, and solar panel before storing. Store indoors in a cool, dry location, away from direct sunlight and heat sources. Do not store the product where temperatures may drop below freezing.

WEATHER	<b>PUMP ON</b> Surplus solar energy is charged to back-up battery
	Solar energy runs the pump and charges the battery. Pump performance is maintained when the clouds pass. Pump runs into the evening/night until the battery is depleted.
	Solar energy runs the pump and surplus energy is stored in the battery. Performance is maintained when the clouds pass. The pump will only run for a short time in the evening until the battery is depleted.
	Pump will only run when there is sufficient power from the battery. Little or no battery charging occurs so pump performance is not maintained or guaranteed.
	No solar power is available, the pump will not run and the battery will not charge.

## WARNING

**INGESTION HAZARD** — This item contains a lithium battery. Keep battery out of reach of children and pets.

## BATTERY INFORMATION

This product uses a built-in rechargeable lithium battery. The battery is not user-replaceable. Do not disassemble, puncture, crush, or modify the solar panel or battery housing. Do not submerge the solar panel or battery housing in water. If the solar panel, battery housing, or cable becomes damaged, swollen, cracked, or unusually hot, discontinue use immediately. Do not attempt to charge the battery using any external power source or charger. Prolonged exposure to extreme heat or freezing temperatures may reduce battery lifespan and performance.

# Care & Maintenance

- Some climates and weather conditions increase water evaporation, requiring water to be added more frequently. Check water levels during times of high temperatures, wind, and long-term exposure to direct sunlight to ensure the pump remains underwater. The pump is equipped with dry-run technology, the pump will shut off when water is low or runs out.
- Only use water in this fountain. Distilled water will help prevent mineral buildup but is not required. Tap water is okay to use, but avoid heavily chlorinated water as it may damage the fountain finish and the pump.
- Over time, the finish may gradually mellow in color due to sun exposure; this is part of the natural aging process and is not cause for return.
- Periodically change the water to help keep the fountain and pump clean. Remove scale and buildup regularly.
- Do not use chemicals, abrasives, or pressure washers to clean the fountain.
- Disconnect power before cleaning. Handle the pump by the body only, never the power cable.
- In freezing weather, drain the fountain, disconnect the pump, and store indoors to prevent damages.

**Warranty Notice: Damage caused by chemicals, coatings, touch-up paint, or cleaning products is not covered.**

## Troubleshooting

- Ensure the solar panel is in full sunlight and all power connections are secure.
- Ensure that the pump is fully submerged in water. If air is trapped, gently tap the pump to release it.
- Check the pump and fountain tubing for obstructions.
- If water is not flowing evenly from the tiers, ensure the fountain is level. Some components may be slightly uneven due to the moulding process, thin plastic shims (included) may be needed to even out spacing between the tiers.

### SAFETY STATEMENTS & WARNINGS

- For outdoor use only.
- Fountains may splash or leak; always protect surfaces that can be damaged by water. Do not use fountain in areas that can be damaged if water splashes or leaks.
- Do not use high-pressure spray nozzles to fill the fountain as doing so may cause the finish to peel.
- Keep fountain out of reach of children and pets.
- Make sure the power cable is away from traffic areas.
- Keep power cables, solar panel, and battery away from all heat sources. Do not place power cables, solar panel, or battery near high-temperature areas.

 This product uses rechargeable batteries. When the batteries can no longer be used the solar panel should be recycled. The solar panel must not be incinerated or composted. Recycle solar panel in accordance with local laws and regulations.

**Any modification to the product or failure to follow recommended care will void the product warranty.**

*If you experience issues with assembly or the product was damaged during transit, please contact our customer service team through one of the methods mentioned at the top of page 1. Please have the item number and order information ready to expedite response time.*

### **WARNING:**

**Manufacturer and seller expressly disclaim any and all liability from personal injury, property damage or loss, whether direct or indirect, or incidental, resulting from the incorrect attachment, improper use, inadequate maintenance, or neglect of this product.**