

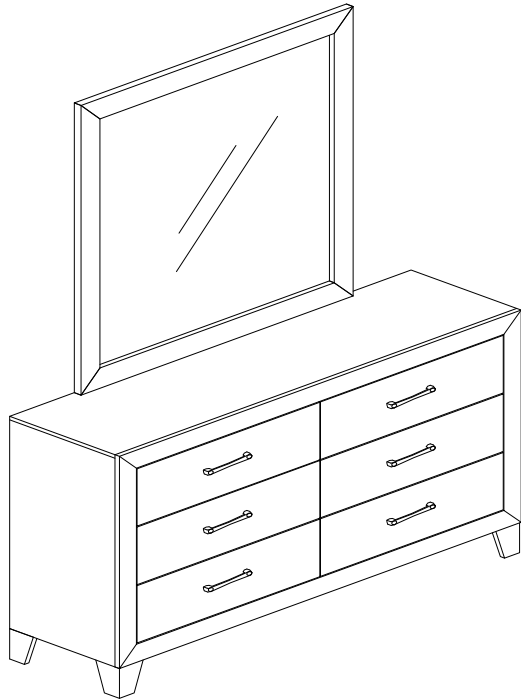



# MIRROR



Thank you for purchasing this quality product . Be sure to check all packing material carefully for small parts that may have come loose inside the carton during shipment.

**\*\*Do not fully tighten screws until fully assembled\*\***



Box of Dresser		
NO	DESCRIPTION	QTY
1	 DRESSER	1

Box of Mirror		
NO	DESCRIPTION	QTY
2	 MIRROR	1
3	 MIRROR SUPPORT	2

Box of Mirror - Hardware List		
NO	DESCRIPTION	QTY
A	 JCBC BOLT M6 x 1.0 x 40 mm	8
B	 ALLEN KEY - M4	1

## COMPLETE ASSEMBLY



PLACE WOOD PARTS ON A CLEAN NON-ABRASIVE SURFACE

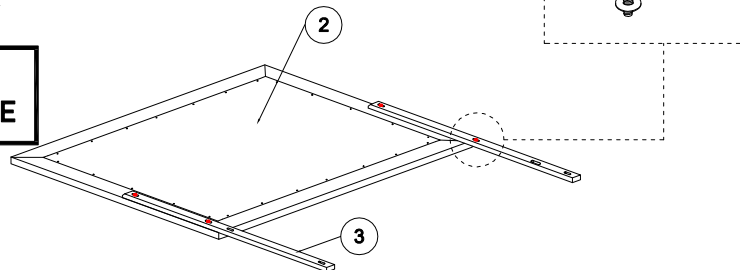

**STEP 1 :** Fix Mirror Support on top of Mirror . Insert JCBC BOLT ( A ) into the holes at the mirror support . Tighten the support rail to the mirror & dresser with JCBC Bolt ( A ) using ALLEN KEY ( D ) .

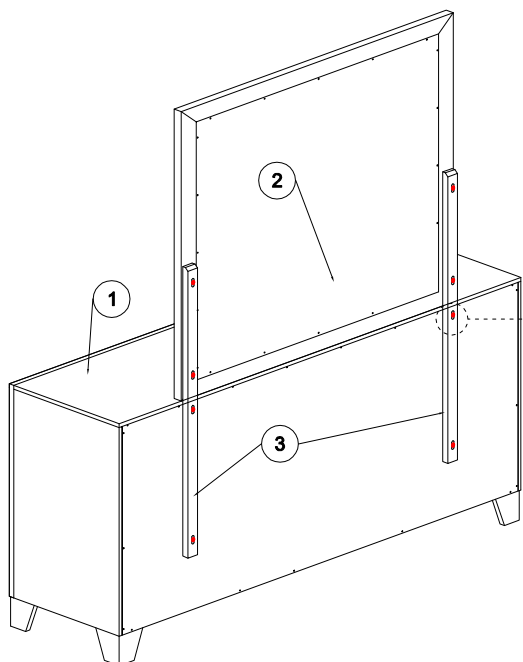

**STEP 2 :** Fix Mirror on top of Dresser . Insert JCBC BOLT ( A ) into the holes at the mirror support . Tighten the support rail to the mirror & dresser with JCBC BOLT ( A ) using ALLEN KEY ( D ) .

The Hardware is Located in the Packing Items.

The Anti Tipping Hardware is Located in the 1st Right Side Front Drawer of Dresser.

NOTE : Pictures for illustration purpose only.

**MADE IN MALAYSIA**