

Rectangle Coffee Table

Assembly Guide

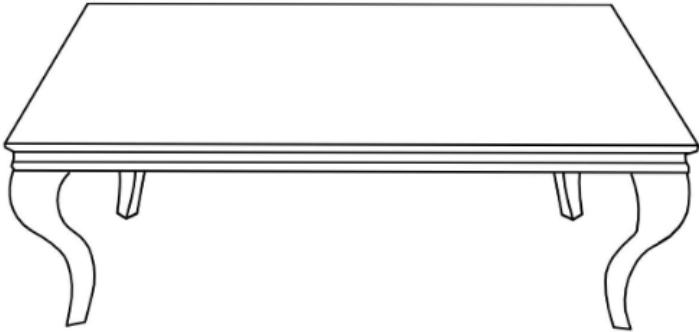

IMPORTANT: please read these instructions fully before starting assembly



**SAFETY AND
CARE ADVICE**



NO POWER TOOLS

- Check you have all the components and tools listed
- Remove all fittings from their bags and separate into groups
- We do not recommend use of power tools - this could damage the unit. Only use hand screwdrivers and Allen keys
- Keep children and animals away from the work area, small parts could cause choking if swallowed
- Make sure you have enough space to lay out the parts before starting
- Assemble the item as close to its final position (same room) as possible
- Do not over tighten the nuts to avoid damage to the threads
- Only clean using a damp cloth and mild detergent. Do not use bleach or abrasive cleaners
- From time to time, check there are no loose screws in this unit
- This product should not be discarded with household waste. Take to your local authority waste disposal centre

IMPORTANT INFORMATION



20 Minute
Build



Two Person
Build









Max Weight
Capacity
50kg

Note: Assembly estimates are approximate and can differ based on the specific environment and user experience.

WHAT'S IN THE BOX

Note: the quantities are the correct amount to complete the assembly. In some cases more fittings may be supplied than are required.

Label	Part Name	Drawing	Quantity
A	Glass Top		1
B	Frame		1
C	Leg		4

Label	Hardware	Drawing	Size (mm)	Quantity
①	Screw		M8x15mm	12
②	Suction Cup		20mm	8
③	Allen Key		M6mm	1
④	Table Foot		M6x15mm	4

Note:

- Use a clear, flat surface to avoid bumps or scratches before assembling.
- Do not fully tighten the fixings until all screws are attached to the legs; then tighten all of them.
- Do not overtighten the screws.



STEP 1

Screw the table foot 【4】 into legs 【C】 .

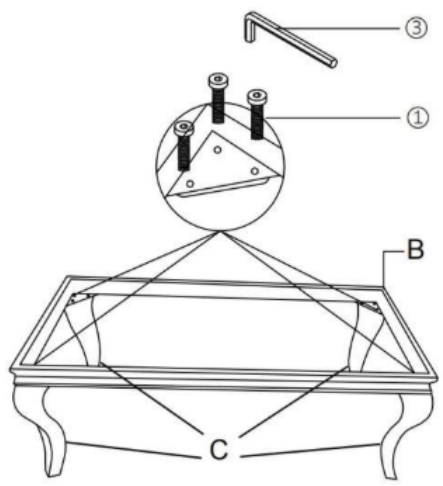

STEP 2

Lift and hold the frame 【B】 in position. Then, use fixings 【3】 and 【1】 to attach the leg 【C】 .

Hardware	Pieces
	1
	12

Note: Ensure that the suction cup is securely fitted into the suction cup hole.

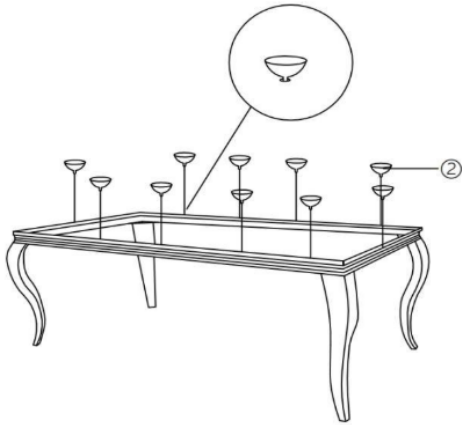

STEP 3

Insert suction cup 【2】 evenly in the frame holes.

Hardware	Pieces
	8

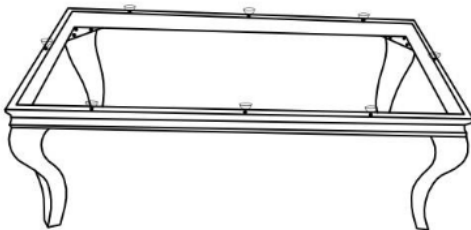
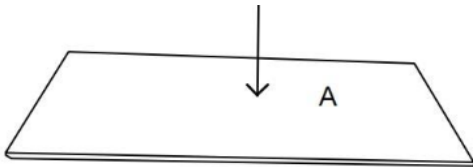

STEP 4

Place the table top 【A】 lightly on the frame 【B】 .

STEP 5

Your table is now fully assembled.

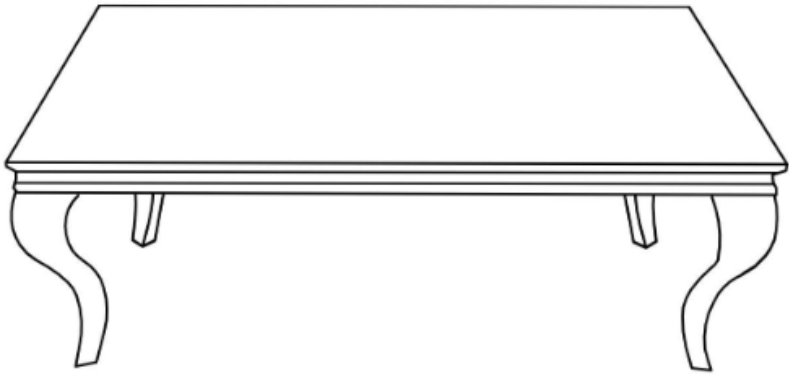



2 YEAR
GUARANTEE

Your item comes with a 2 year guarantee to give you peace of mind when shopping

WHAT THE GUARANTEE COVERS



PRE-INSERTED FIXINGS
e.g. loose metal threads



FAULTY JOINTS
e.g. legs bending



EXTERNAL FIXING FAULTS
e.g. metal discs removing
from table top



STRUCTURAL INTEGRITY
e.g. the frame of the
product