

Assembly Instructions

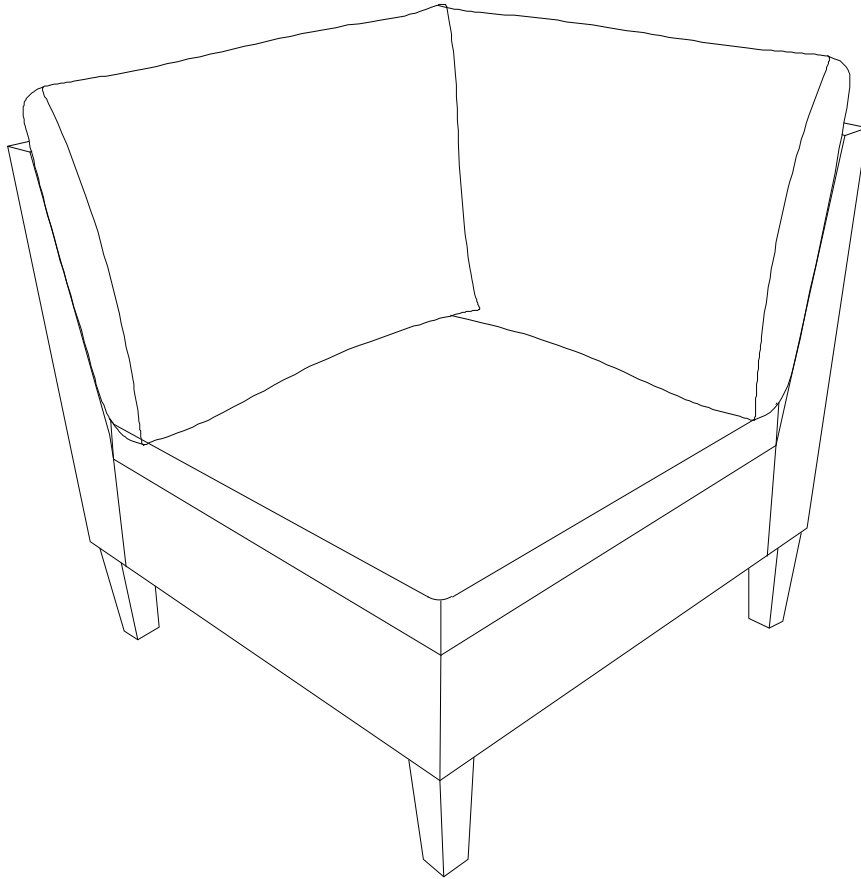







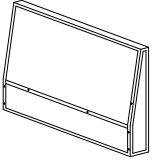

For any missing hardware, damaged parts and other problems.
WELCOME to email us at: service@behousewell.com

Or call at 1-888-733-8169 Toll free
Between 9AM and 5PM Eastern time, Monday through Friday

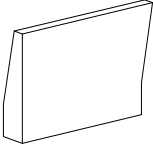
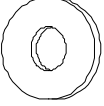
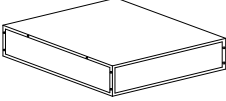
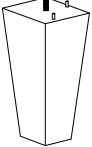
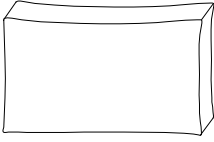
***Don't fully tighten all the bolts till the very end!**

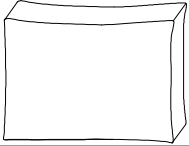
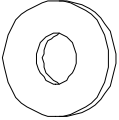
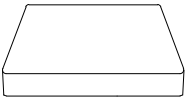
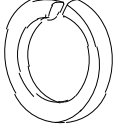

PRE-ASSEMBLY PREPARATION:

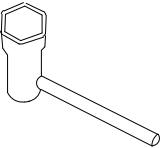
- Please read through the instructions before beginning assembly.
- Clear out the space for assembly and lay out all of the parts based on the Parts List, extra room will allow you to easily determine if all the pieces are present.
- Keep small parts and pieces away from children until fully assembled.

Part no.	Part	QTY	Image	Part no.	Part	QTY	Image
A	Back panel	1		I	Bolt (M6*95mm)	1	
B	Side panel	1		J	Washer Ø16*Ø6.5*1mm	11	
C	Seat	1		K	Leg	4	
D	Long back cushion	1		L	Nut M8	4	
E	Short back cushion	1		M	Washer Ø18*Ø8.5*1mm	4	
F	Seat cushion	1		N	Spring washer Ø8.5mm	4	
G	Bolt (M6*30mm)	6		O	Allen Wrench	1	
H	Bolt (M6*40mm)	4		P	Wrench	1	

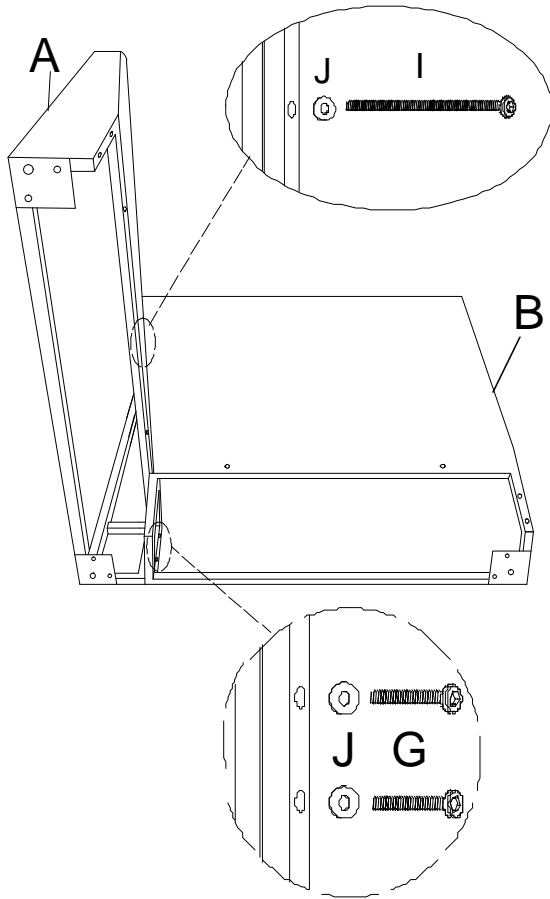

Step 1: Attach part A to part B with 1pc bolt I, 2pcs bolts G and 3pcs washers J, using Allen wrench O. Note: Don't fully tighten the bolts.



I		M6*95	1
G		M6*30	2
J		Ø16*Ø6.5*1	3

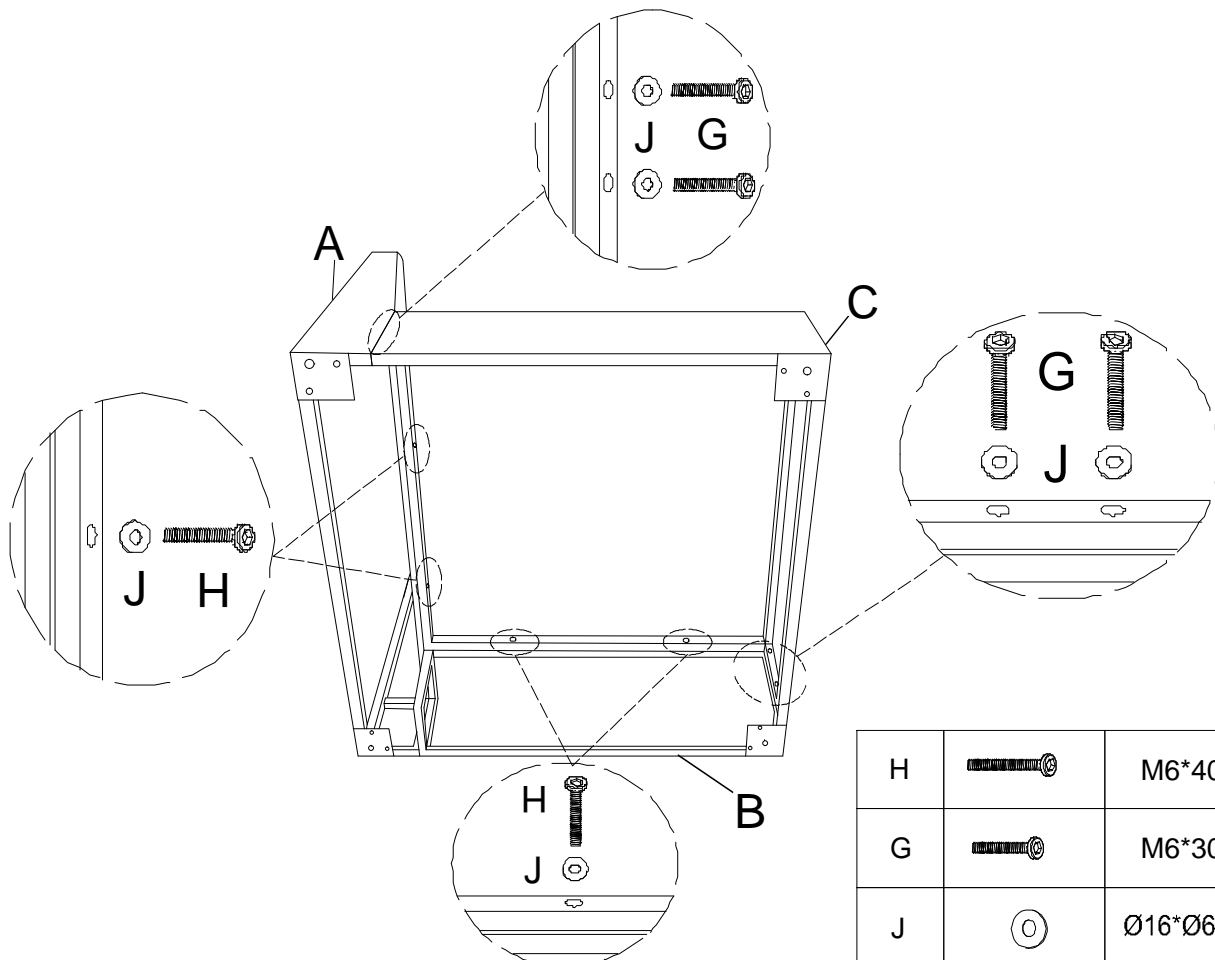

Step 2: Attach part C to part A and B with 4pcs bolts H, 4pcs bolts G and 8pcs washers J, using Allen wrench O. Note: Don't fully tighten the bolts.

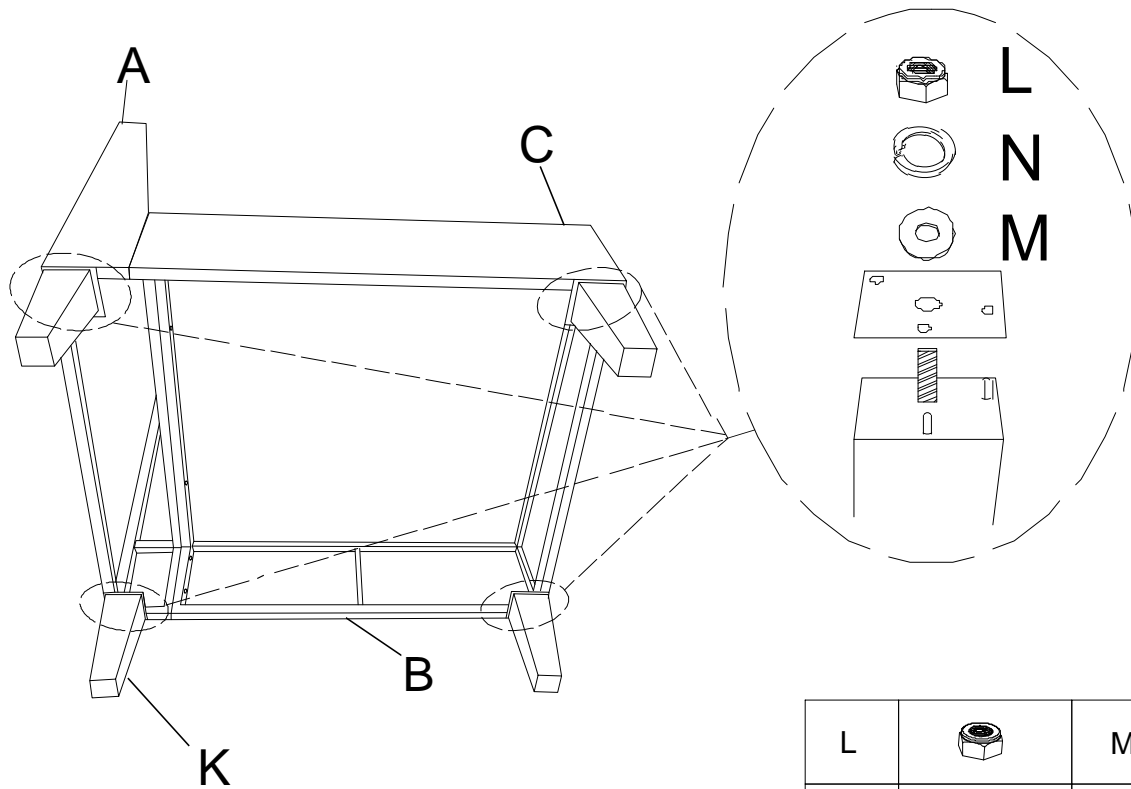

H		M6*40	4
G		M6*30	4
J		Ø16*Ø6.5*1	8

Step 3: Attach legs K to part A&B&C with 4pcs washers M, 4pcs spring washers N and 4pcs nuts L, using wrench P.



L		M8	4
M		Ø18*Ø8.5*1	4
N		Ø8.5	4

Step 4: Put seat cushion F and back cushion D&E onto the seat. Assembly is now complete and the product is ready for use.

