

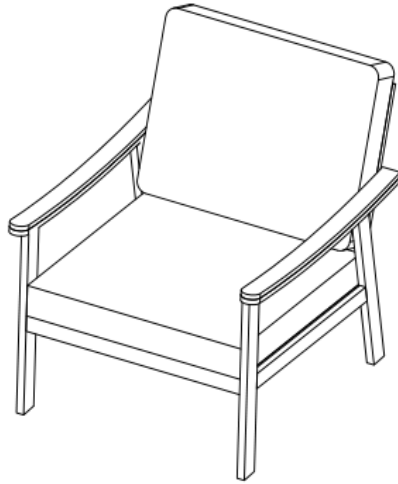



# Assembly Instructions

Caution: You must read this before you proceed





## Club Chair

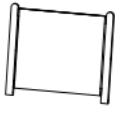
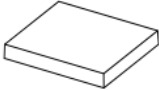
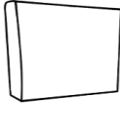

### Part List

Label	Picture	Description	QTY
A		Right Armrest	1
B		Left Armrest	1
C		Seat Panel	1
D		Backrest	1
E		Seat Cushion	1
F		Back Cushion	1

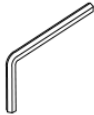
## Hardware

Label	Picture	Description	QTY
①		Bolt (M6*35mm)	9
②		Bolt (M6*65mm)	5
③		Allen Key	1
④		Cap	13
⑤		Washer	13

## Assembly Preparation

Before Beginning Assembly:

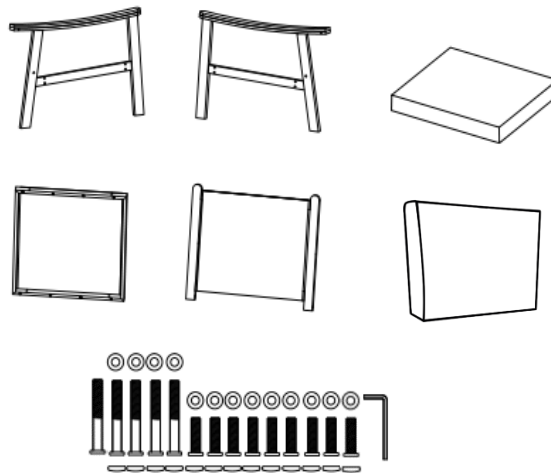

- Read instructions, cover to cover-



- Have 2 adults on hand for assembly-



- Do not assemble on flooring or carpet-



- Assemble on a clean non-marring surface (packing foam)-



- Save all packaging until finished-

# Assembly Steps

## Overview

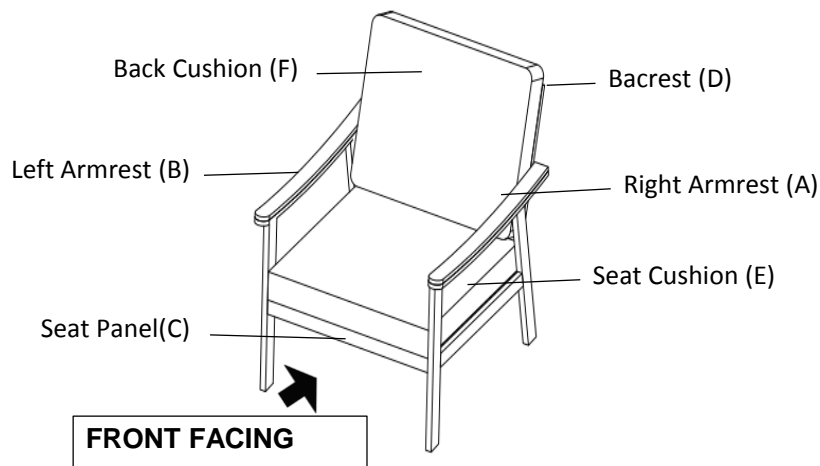

This Club Chair has multiple parts and may require up to 30 minutes to assemble. To give you an overview of the side Club Chair parts, the above picture is to help you put the various parts into perspective. Please read through the instructions below to familiarise yourself with the parts and steps before assembly.

## Step 1

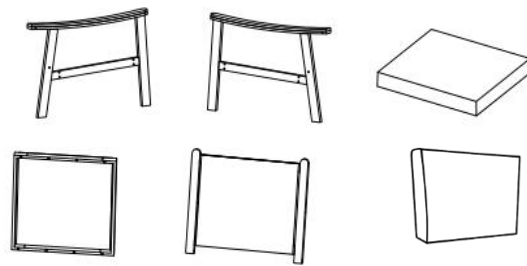

Unpack and place all parts on a clean, non-marring surface.

## Step 2

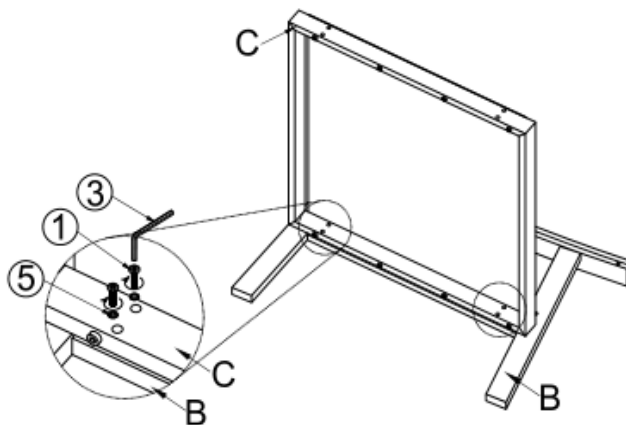

Attach Seat Panel (C) to Left Armrest (B) using Bolts (①) and Washers (⑤) with Allen Key (③).  
**Do not fully tighten the Bolts.**

### Step 3

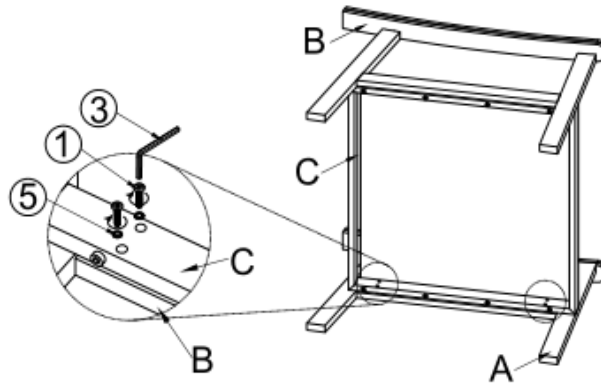

Attach Seat Panel(C) to Right Armrest(A) using Bolts(①) and Washers(⑤) with Allen Key(③).  
**Do not fully tighten the Bolts.**

### Step 4

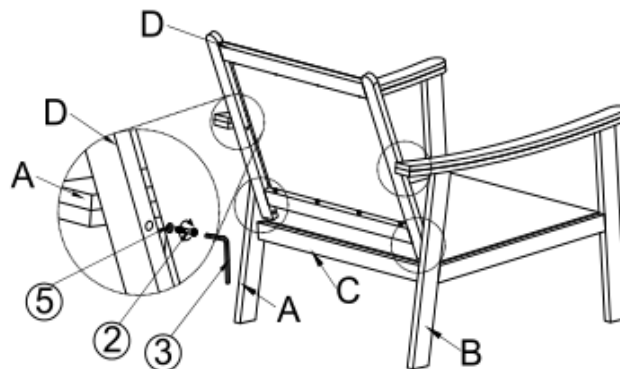

Attach Backrest(D) to Left Armrest(B) and Right Armrest(A) using Bolts(②) and Washers(⑤) with Allen Key(③).  
**Do not fully tighten the Bolts.**

### Step 5

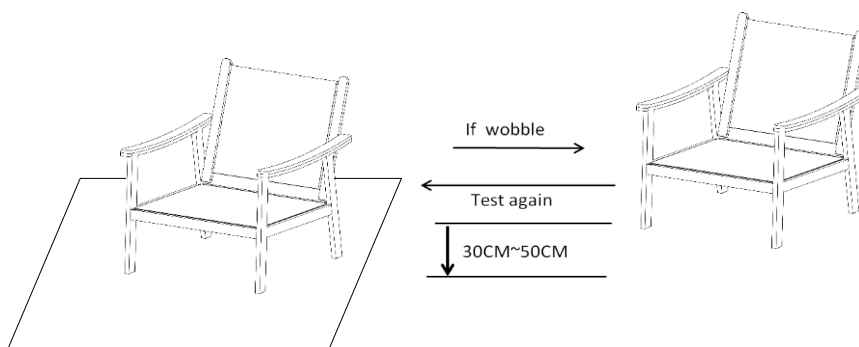

Place the Club Chair on a **LEVEL SURFACE** to see if it wobbles.  
If it wobbles, lift the Club Chair some 30cm to 50cm high from the ground.  
Keep your feet and toes well away from the drop zone.  
Drop the Club Chair freely and vertically with the four legs, hitting the ground, at the same time.  
This Drop Test will help to ensure that all the Bolts and gaps all reach full alignment status.  
Test again for evenness on a **LEVEL SURFACE**.  
If no wobbles are found, proceed to tighten all the Bolts.  
**When tightening the Bolts, tighten sequentially.**  
**DO NOT tighten any Bolt fully and then move on to the next one.**  
**This may cause the frame to warp.**  
**If there are still wobbles, loosen the Bolts and execute the same drop test.**

### Step 6

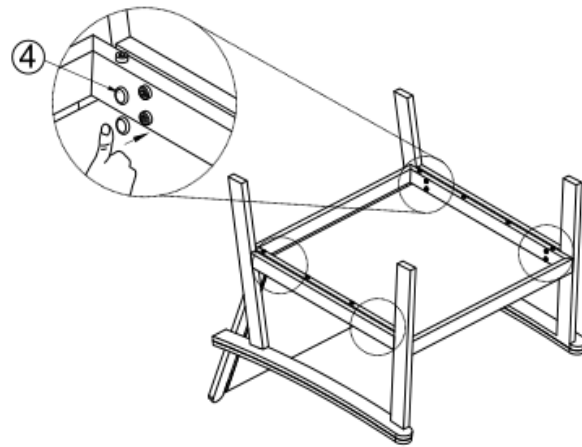

Cover the Bolts with Caps(4) after tightening.

### Step 7

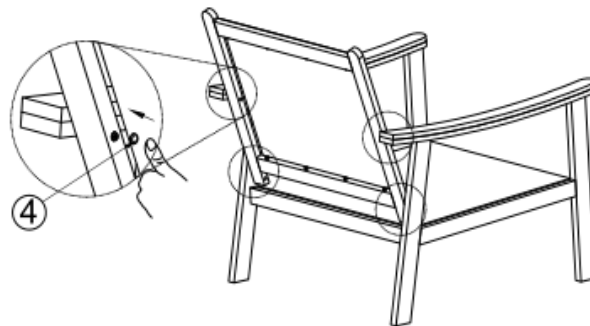

Cover the Bolts with Caps(4) after tightening.

### Step 8

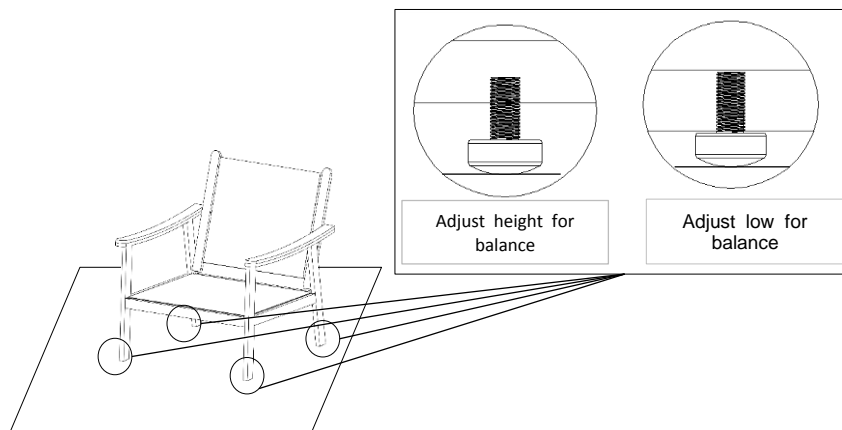

At this point, ensure all bolts and nuts are fully tightened and secured.

Then, with the assistance of your adult partner, proceed to turn and stand the Loveseat upright. Adjust the Legs Pre-installed Levellers until the Loveseat is level with the ground.

To adjust the Levellers, with the assistance of your adult partner, tilt the Loveseat to rest on the 2 feet. Adjust the levellers to the desired height to avoid wobbles.



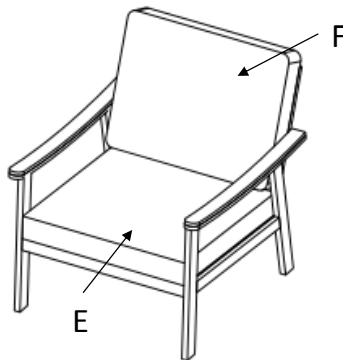

















## Step 9



Place the Seat Cushion(E) and Back Cushion(F) on the Club Chair.  
Your Club Chair is ready for use.

**This Club Chair can only be used on a flat, level surface.**

### Care & Maintenance

-   ● Do not put hot items directly on furniture surface
-   ● Do not clean furniture with harsh cleansers or polish.
-   ● To obtain the longest lifespan of your outdoor products, minimizing exposure to direct sunlight is recommended.
-   ● Children should not climb or jump on the furniture.
-   ● Do not write on furniture without a padded barrier to protect the surface.
-   ● To obtain the longest lifespan of your outdoor products, avoid extended and lengthy exposure to rain, snow, and direct sunshine. Whenever possible cover the product and /or place under patio or awnings.
-   ● Not for commercial use. For residential use only .
-   ● Stains may be removed with mild soap solution and damp cloth.
-   ● Keep away from sources of ignition.
-   ● Dust and pick-up spills using a clean, non-colored, lint-free cloth.

### Questions & Answers about Proposition 65

#### • What is Proposition 65?

Proposition 65 requires businesses to provide warnings to Californians about significant exposures to chemicals that cause cancer, birth defects or other reproductive harm. These chemicals can be in the products that Californians purchase, in their homes or workplaces, or that are released into the environment. By requiring that this information be provided, Proposition 65 enables Californians to make informed decisions about their exposures to these chemicals.

Proposition 65 also prohibits California businesses from knowingly discharging significant amounts of listed chemicals into sources of drinking water.

Proposition 65 requires California to publish a list of chemicals known to cause cancer, birth defects or other reproductive harm. This list, which must be updated at least once a year, has grown to include approximately 900 chemicals since it was first published in 1987.

#### • What types of chemicals are on the Proposition 65 list?

The list contains a wide range of naturally occurring and synthetic chemicals that include additives or ingredients in pesticides, common household products, food, drugs, dyes, or solvents. Listed chemicals may also be used in manufacturing and construction, or they may be byproducts of chemical processes, such as motor vehicle exhaust.

#### • What does a warning mean?

If a warning is placed on a product label or posted or distributed at a workplace, a business, or in rental housing, the business issuing the warning is aware or believes that it is exposing individuals to one or more listed chemicals.

By law, a warning must be given for listed chemicals unless the exposure is low enough to pose no significant risk of cancer or is significantly below levels observed to cause birth defects or other reproductive harm.

#### • Where can I get more information on Proposition 65?

If you have specific questions on the administration or implementation of Proposition 65, you can contact OEHHHA's Proposition 65 program at [P65.Questions@oehha.ca.gov](mailto:P65.Questions@oehha.ca.gov), or by phone at (916) 445-6900.



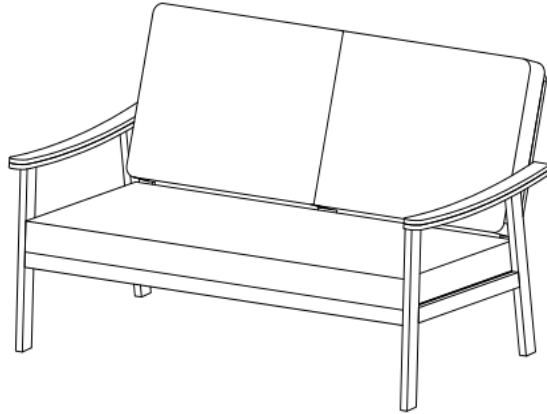

# Assembly Instructions

**Caution: You must read this before you proceed**



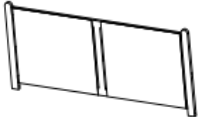

## Loveseat

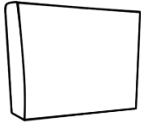

### Part List

Label	Picture	Description	QTY
A		Right Armrest	1
B		Left Armrest	1
G		Seat Panel	1
H		Backrest	1
I		Seat Cushion	1
F		Back Cushion	2

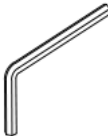
## Hardware

Label	Picture	Description	QTY
①		Bolt (M6*35mm)	9
②		Bolt (M6*65mm)	5
③		Allen Key	1
④		Cap	13
⑤		Washer	13

## Assembly Preparation

Before Beginning  
Assembly:

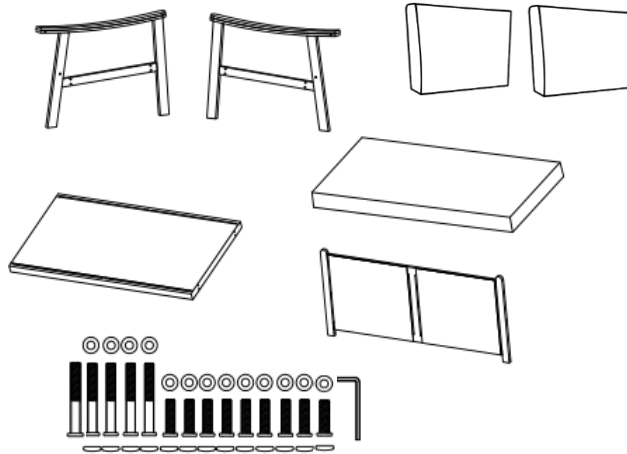

- Read instructions, cover to cover-



- Have 2 adults on hand for assembly-



- Do not assemble on flooring or carpet-



- Assemble on a clean non-marring surface (packing foam)-



- Save all packaging until finished-

# Assembly Steps

## Overview

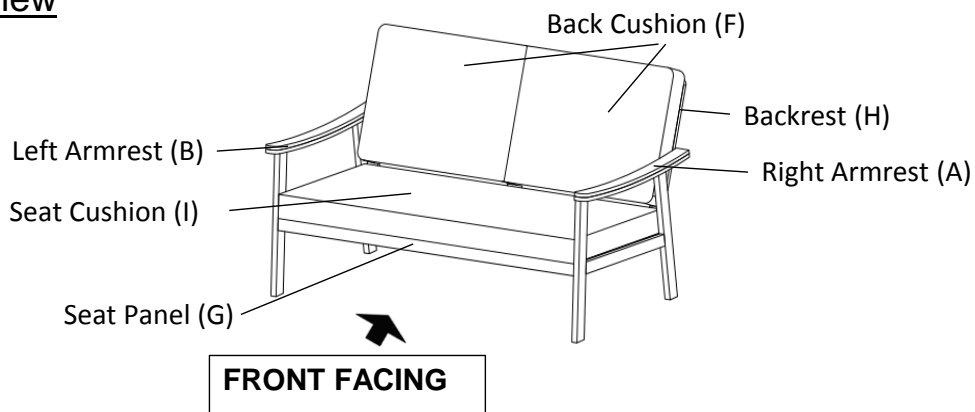

This Loveseat has multiple parts and may require up to 30 minutes to assemble. To give you an overview of the Loveseat parts, the above picture is to help you put the various parts into perspective. Please read through the instructions below to familiarise yourself with the parts and steps before assembly.

## Step 1

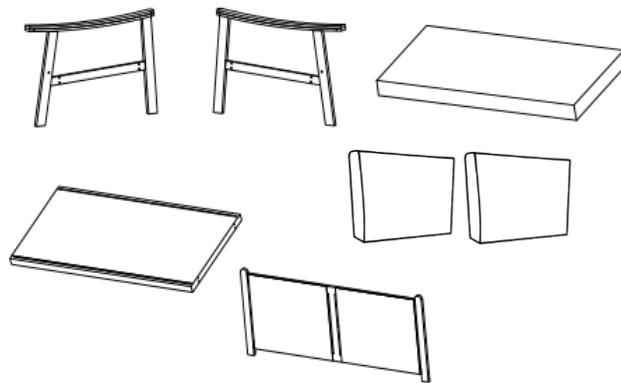

Unpack and place all parts on a clean, non-marring surface.

## Step 2

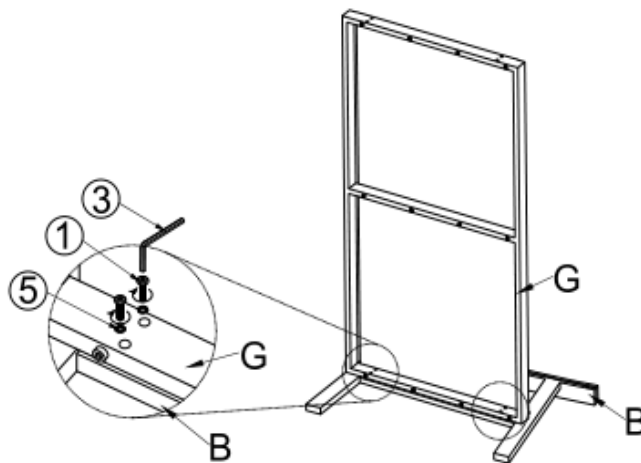

Attach Seat Panel(G) to Left Armrest(B) using Bolts(1) and Washers(5) with Allen Key(3).  
**Do not fully tighten the Bolts.**

### Step 3

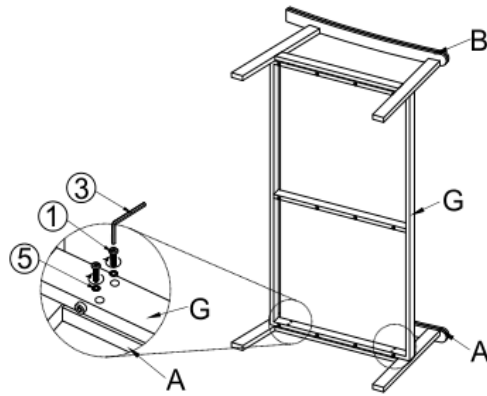

Attach Seat Panel(G) to Right Armrest(A) using Bolts(①) and Washers(⑤) with Allen Key(③).  
**Do not fully tighten the Bolts.**

### Step 4

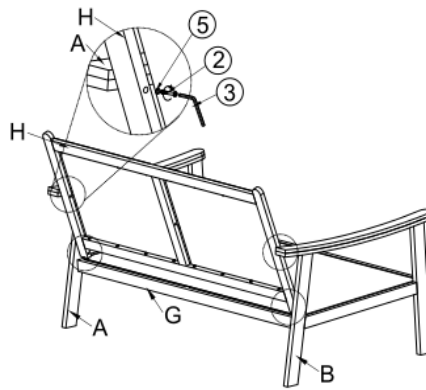

Attach Backrest(H) to Left Armrest(B) and Right Armrest(A) using Bolts(②) and Washers(⑤) with Allen Key(③).  
**Do not fully tighten the Bolts.**

### Step 5

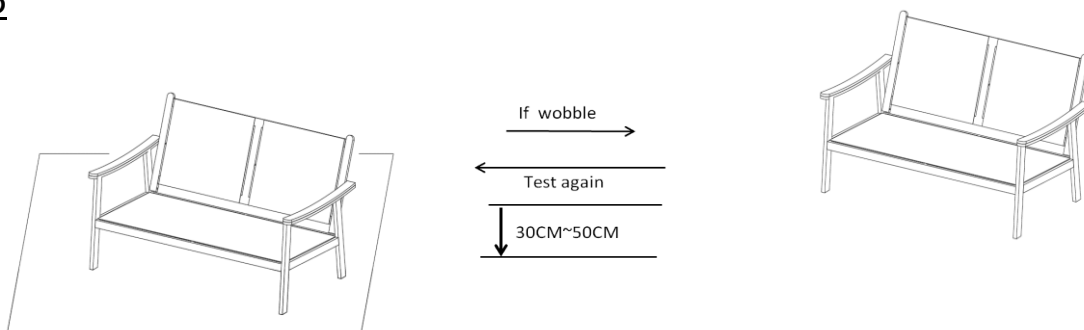

Place the Loveseat on a **LEVEL SURFACE** to see if it wobbles.  
If it wobbles, lift the Loveseat some 30cm to 50cm high from the ground.  
Keep your feet and toes well away from the drop zone.  
Drop the Loveseat freely and vertically with the four legs, hitting the ground, at the same time.  
This Drop Test will help to ensure that all the Bolts and gaps all reach full alignment status.  
Test again for evenness on a **LEVEL SURFACE**.  
If no wobbles are found, proceed to tighten all the Bolts.  
**When tightening the Bolts, tighten sequentially.**  
**DO NOT tighten any Bolt fully and then move on to the next one.**  
**This may cause the frame to warp.**  
**If there are still wobbles, loosen the Bolts and execute the same drop test.**

### Step 6

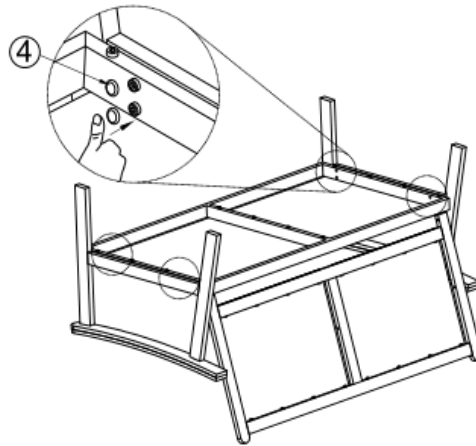

Cover the Bolts with Caps(④) after tightening.

### Step 6

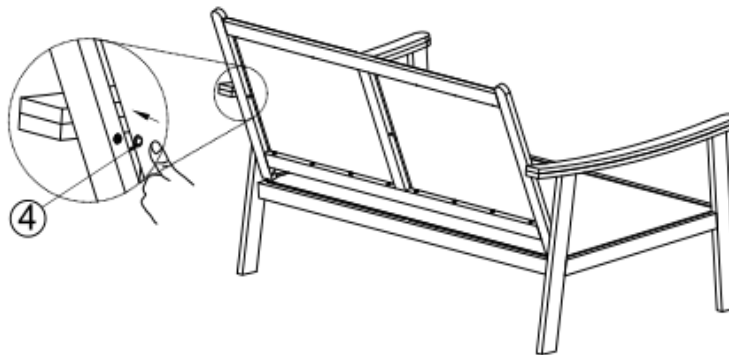

Cover the Bolts with Caps(④) after tightening.

### Step 7

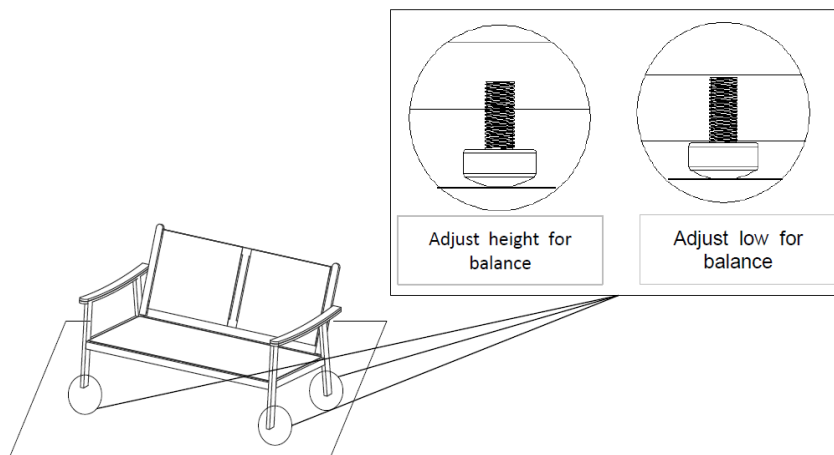

At this point, ensure all bolts and nuts are fully tightened and secured.

Then, with the assistance of your adult partner, proceed to turn and stand the Loveseat upright. Adjust the Legs Pre-installed Levellers until the Loveseat is level with the ground.

To adjust the Levellers, with the assistance of your adult partner, tilt the Loveseat to rest on the 2 feet.

Adjust the levellers to the desired height to avoid wobbles.



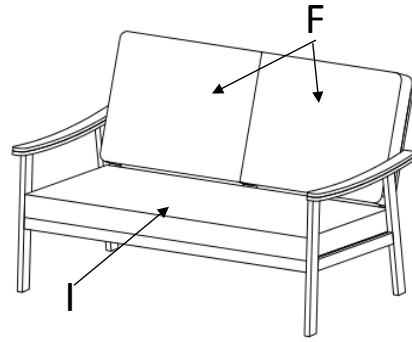

















## Step 8



Place the Seat Cushion(I) and Back Cushions(F) on the Loveseat.  
Your Loveseat is ready for use.

**This Loveseat can only be used on a flat, level surface.**

### Care & Maintenance

-   ● Do not put hot items directly on furniture surface
-   ● Do not clean furniture with harsh cleansers or polish.
-   ● To obtain the longest lifespan of your outdoor products, minimizing exposure to direct sunlight is recommended.
-   ● Children should not climb or jump on the furniture.
-   ● Do not write on furniture without a padded barrier to protect the surface.
-   ● To obtain the longest lifespan of your outdoor products, avoid extended and lengthy exposure to rain, snow, and direct sunshine. Whenever possible cover the product and /or place under patio or awnings.
-   ● Not for commercial use. For residential use only .
-   ● Stains may be removed with mild soap solution and damp cloth.
-   ● Keep away from sources of ignition.
-   ● Dust and pick-up spills using a clean, non-colored, lint-free cloth.

### Questions & Answers about Proposition 65

#### • What is Proposition 65?

Proposition 65 requires businesses to provide warnings to Californians about significant exposures to chemicals that cause cancer, birth defects or other reproductive harm. These chemicals can be in the products that Californians purchase, in their homes or workplaces, or that are released into the environment. By requiring that this information be provided, Proposition 65 enables Californians to make informed decisions about their exposures to these chemicals. Proposition 65 also prohibits California businesses from knowingly discharging significant amounts of listed chemicals into sources of drinking water.

Proposition 65 requires California to publish a list of chemicals known to cause cancer, birth defects or other reproductive harm. This list, which must be updated at least once a year, has grown to include approximately 900 chemicals since it was first published in 1987.

#### • What types of chemicals are on the Proposition 65 list?

The list contains a wide range of naturally occurring and synthetic chemicals that include additives or ingredients in pesticides, common household products, food, drugs, dyes, or solvents. Listed chemicals may also be used in manufacturing and construction, or they may be byproducts of chemical processes, such as motor vehicle exhaust.

#### • What does a warning mean?

If a warning is placed on a product label or posted or distributed at a workplace, a business, or in rental housing, the business issuing the warning is aware or believes that it is exposing individuals to one or more listed chemicals. By law, a warning must be given for listed chemicals unless the exposure is low enough to pose no significant risk of cancer or is significantly below levels observed to cause birth defects or other reproductive harm.

#### • Where can I get more information on Proposition 65?

If you have specific questions on the administration or implementation of Proposition 65, you can contact OEHHA's Proposition 65 program at [P65.Questions@oehha.ca.gov](mailto:P65.Questions@oehha.ca.gov), or by phone at (916) 445-6900.



# Assembly Instructions

Caution: You must read this before you proceed

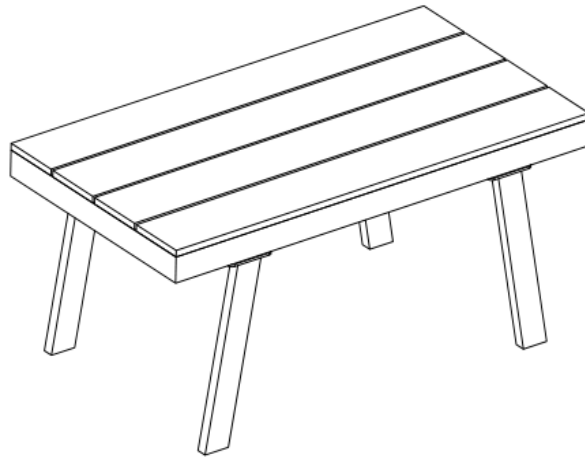

## Coffee Table



### Part List

Label	Picture	Description	QTY
J		Table Top	1
K		Leg	4

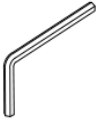
### Hardware

Label	Picture	Description	QTY
⑥		Bolt (M6*20mm)	17
③		Allen Key	1
④		Cap	17
⑤		Washer	17

## Assembly Preparation

Before Beginning Assembly:

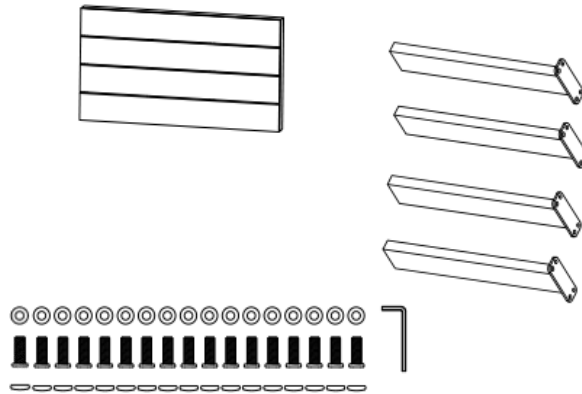

- Read instructions, cover to cover-



- Have 2 adults on hand for assembly-



- Do not assemble on flooring or carpet-



- Assemble on a clean non-marring surface (packing foam)-



- Save all packaging until finished-

## Assembly Steps

### Overview

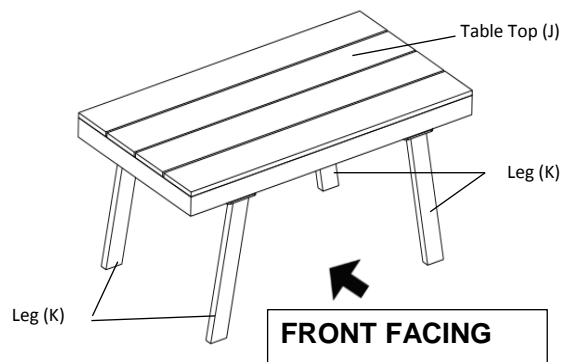

This Coffee Table has multiple parts and may require up to 30 minutes to assemble. To give you an overview of the Coffee Table parts, the above picture is to help you put the various parts into perspective. Please read through the instructions below to familiarise yourself with the parts and steps before assembly.

### Step 1

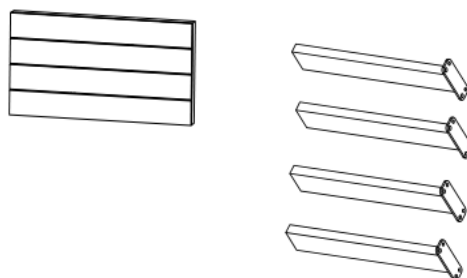

Unpack and place all parts on a clean, non-marring surface.

## Step 2

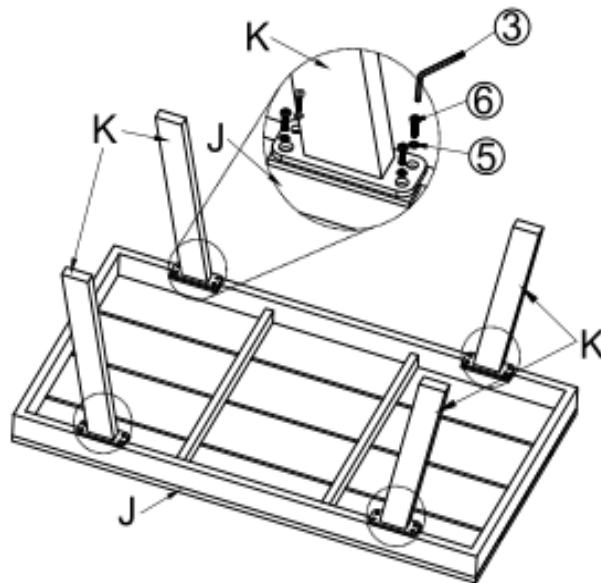

Place the Table Top(J) facedown upon the clean, non-marring surface.  
Attach one Leg(K) to Table Top(J) using Bolts(6) and Washers(5) with Allen Key(3).  
**Do not fully tighten the Bolts.**  
Repeat the same process with the remaining three Legs.

## Step 3

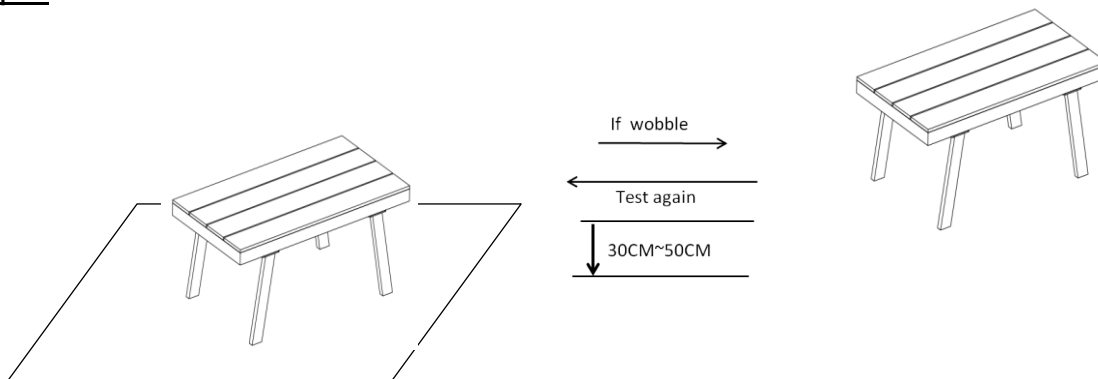

Place the Coffee Table on a LEVEL SURFACE to see if it wobbles.  
If it wobbles, lift the Coffee Table some 30cm to 50cm high from the ground.  
Keep your feet and toes well away from the drop zone.  
Drop the Coffee Table freely and vertically with the four legs, hitting the ground, at the same time.  
This Drop Test will help to ensure that all the Bolts and gaps all reach full alignment status.  
Test again for evenness on a LEVEL SURFACE.  
If no wobbles are found, proceed to tighten all the Bolts.  
**When tightening the Bolts, tighten sequentially.**  
**DO NOT tighten any Bolt fully and then move on to the next one.**  
**This may cause the frame to warp.**  
**If there are still wobbles, loosen the Bolts and execute the same drop test.**

## Step 4

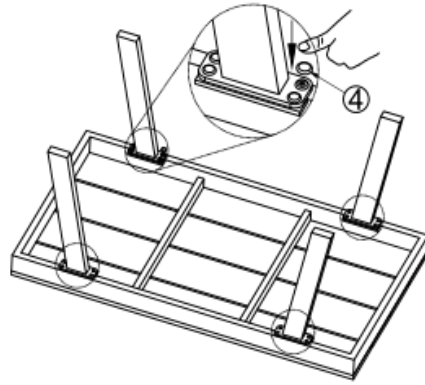

Cover the Bolts with Caps(④) after tightening.

## Step 5

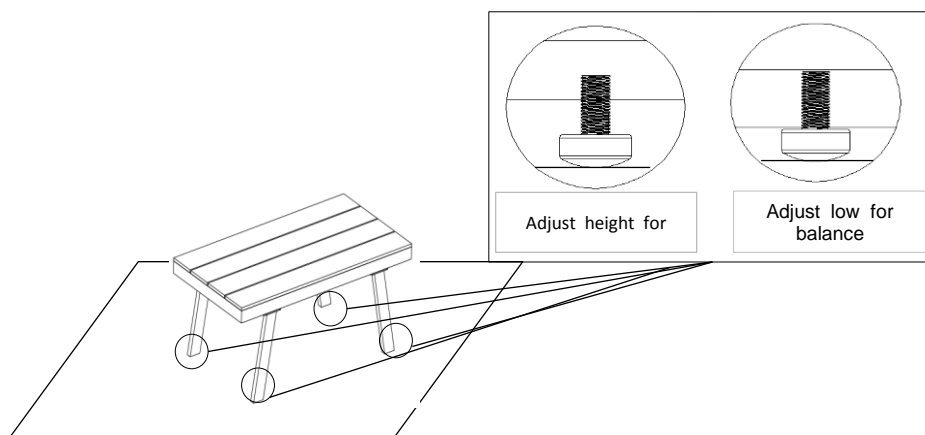

At this point, ensure all bolts and nuts are fully tightened and secured.

Then, with the assistance of your adult partner, proceed to turn and stand the Chair upright. Adjust the Legs Pre-installed Levellers until the Table is level with the ground.

To adjust the Levellers, with the assistance of your adult partner, tilt the Table to rest on the 2 feet. Adjust the levellers to the desired height to avoid wobbles.



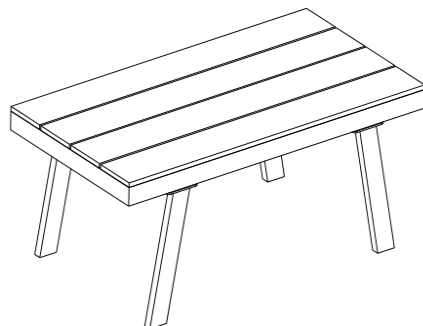

















## Step 6



Your Coffee Table is ready for use.

**This Coffee Table can only be used on a flat, level surface.**

## Care & Maintenance

-   ● Do not put hot items directly on furniture surface
  -   ● Do not clean furniture with harsh cleansers or polish.
  -   ● To obtain the longest lifespan of your outdoor products, minimizing exposure to direct sunlight is recommended.
  -   ● Children should not climb or jump on the furniture.
  -   ● Do not write on furniture without a padded barrier to protect the surface.
  -   ● To obtain the longest lifespan of your outdoor products, avoid extended and lengthy exposure to rain, snow, and direct sunshine. Whenever possible cover the product and /or place under patio or awnings.
  -   ● Not for commercial use. For residential use only .
  -   ● Stains may be removed with mild soap solution and damp cloth.
  -   ● Keep away from sources of ignition.
- 
-   ● Dust and pick-up spills using a clean, non-colored, lint-free cloth.

## Questions & Answers about Proposition 65

### • What is Proposition 65?

Proposition 65 requires businesses to provide warnings to Californians about significant exposures to chemicals that cause cancer, birth defects or other reproductive harm. These chemicals can be in the products that Californians purchase, in their homes or workplaces, or that are released into the environment. By requiring that this information be provided, Proposition 65 enables Californians to make informed decisions about their exposures to these chemicals.

Proposition 65 also prohibits California businesses from knowingly discharging significant amounts of listed chemicals into sources of drinking water.

Proposition 65 requires California to publish a list of chemicals known to cause cancer, birth defects or other reproductive harm. This list, which must be updated at least once a year, has grown to include approximately 900 chemicals since it was first published in 1987.

### • What types of chemicals are on the Proposition 65 list?

The list contains a wide range of naturally occurring and synthetic chemicals that include additives or ingredients in pesticides, common household products, food, drugs, dyes, or solvents. Listed chemicals may also be used in manufacturing and construction, or they may be byproducts of chemical processes, such as motor vehicle exhaust.

### • What does a warning mean?

If a warning is placed on a product label or posted or distributed at a workplace, a business, or in rental housing, the business issuing the warning is aware or believes that it is exposing individuals to one or more listed chemicals.

By law, a warning must be given for listed chemicals unless the exposure is low enough to pose no significant risk of cancer or is significantly below levels observed to cause birth defects or other reproductive harm.

### • Where can I get more information on Proposition 65?

If you have specific questions on the administration or implementation of Proposition 65, you can contact OEHHA's Proposition 65 program at [P65.Questions@oehha.ca.gov](mailto:P65.Questions@oehha.ca.gov), or by phone at (916) 445-6900.