

TRESTLE DESK WITH CHARGING STATION

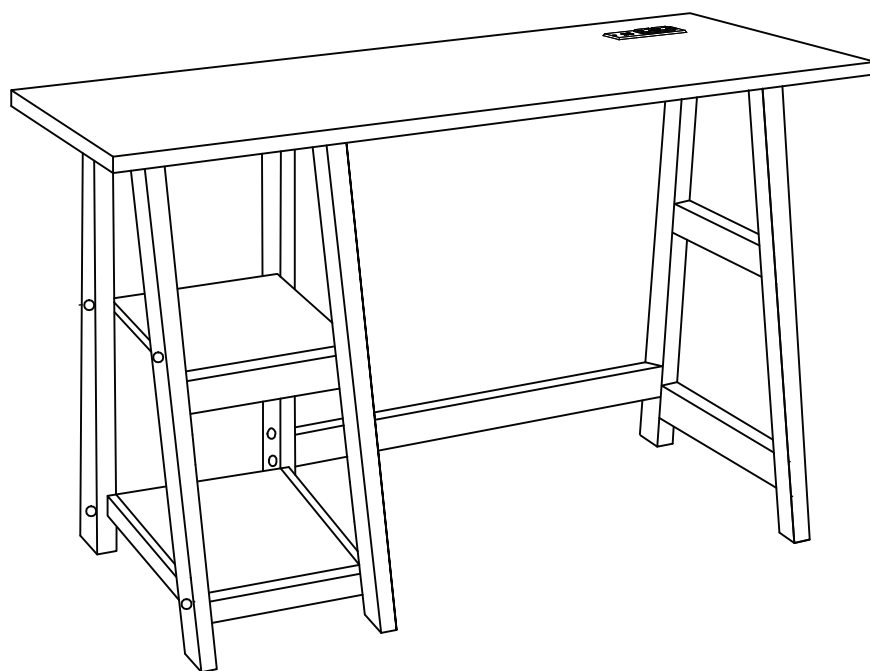







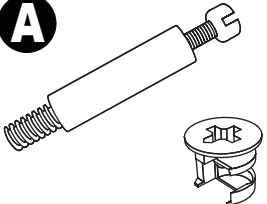
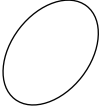
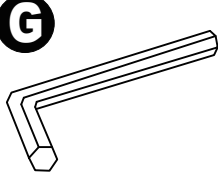
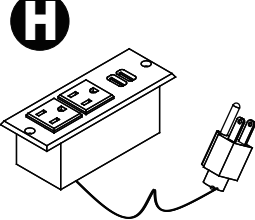

ASSEMBLY INSTRUCTIONS

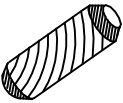
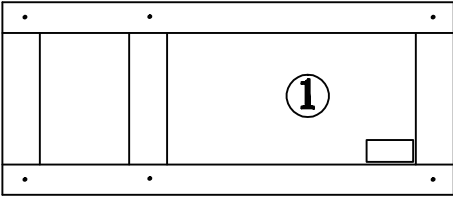
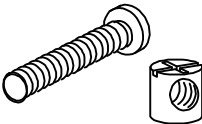

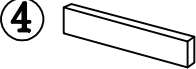
We have designed our furniture with you , the customer in mind . Our clear , easy to follow , step by step instructions will guide you through the project from start to finish .

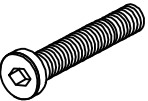
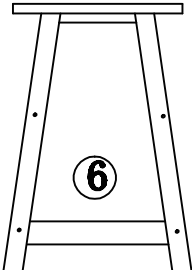
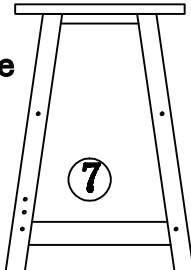
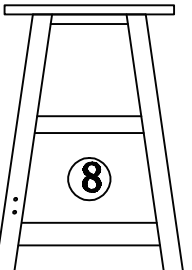
Feel confident that this will be a fun and rewarding project . The final product will be a quality piece of furniture that will go together smoothly and give years of enjoyment .

Hardware List

				
<p>Cambolt & Camlock (4pcs)</p>	<p>Hole sticker (12pcs)</p>	<p>Allen wrench (1pc)</p>	<p>Socket Strip(1pc)</p>	<p>Small Screw (2pc)</p>
<p>Part List</p>				
	 <p style="text-align: right;">Desktop (1pc)</p>			
<p>Wood dowel (8pcs)</p>				
	 <p>Middle Shelf (1pc)</p>  <p>Bottom Shelf (1pc)</p>  <p>Shelf Supports (4pcs)</p>  <p>Support Rail (1pc)</p>			
<p>Long Screw & Inserted Nut (12pcs)</p>				
	 <p>Left Frame (1pc)</p>  <p>Middle Frame (1pc)</p>  <p>Right Frame (1pc)</p>			
<p>Screw (6pcs)</p>				
				
<p>Glue (1pc)</p>				

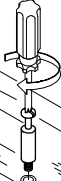
Assembling the unit with camlocks and wood dowels.

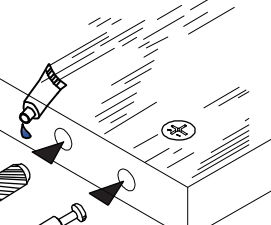
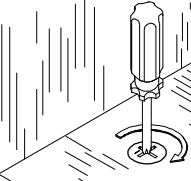
				
<p>Insert camlock, camlock must face bolt hole</p>	<p>Gently screw cambolt into the threaded anchor</p>	<p>Lightly glue one end of wood dowel and tap into hole.</p>	<p>Lightly glue dowel and connect to second panel by inserting dowels into holes</p>	<p>Gently screw the camlock clockwise into locked position. Do not overtighten.</p>

step1

1. Insert Wooden dowels (B) and screw Cambolts (A) to Middle Shelf (2)
2. Insert Camlocks (A) into holes in Shelf Supports (4). **Camlock arrow must face bolt hole.**
3. Connect Shelf Supports (4) to Middle Shelf (2).
Gently tighten camlocks.

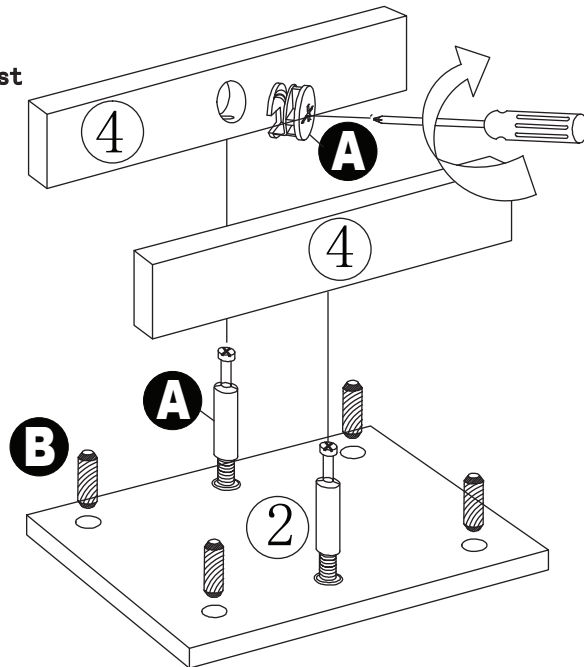
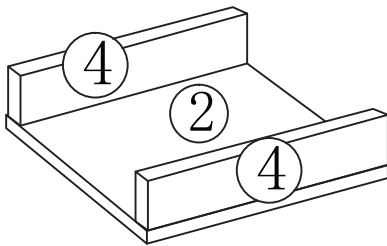

*Refer to page 2 for cam assembly

step2

1. Insert Wooden dowels (B) and screw Cambolts (A) to Bottom Shelf (3)
2. Insert Camlocks (A) into holes in Shelf Supports (4). **Camlock arrow must face bolt hole.**
3. Connect Shelf Supports (4) to Bottom Shelf (3).
Gently tighten camlocks.

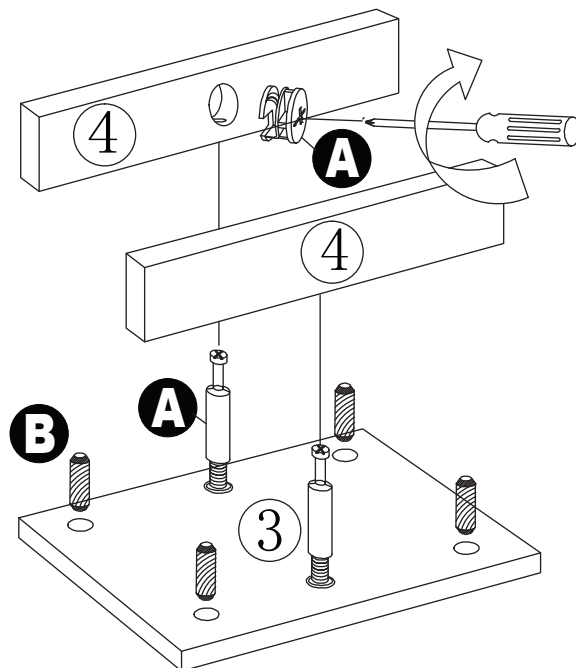
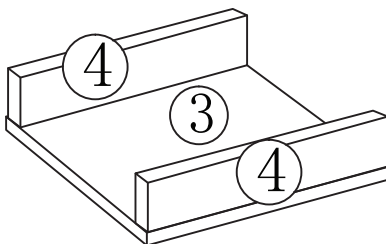

step3

1. Insert Nuts into Middle Shelf (2) and Bottom Shelf (3) and **make sure Nut hole faces to bolt hole.** (as seen in Diagram #1)
2. Carefully connect Left Frame (6) and Middle Frame (7) to Shelves (2) and (3). (Long Screw (G) goes through the Frame. Line up holes and insert screws.)
Tighten Long Screws (G).

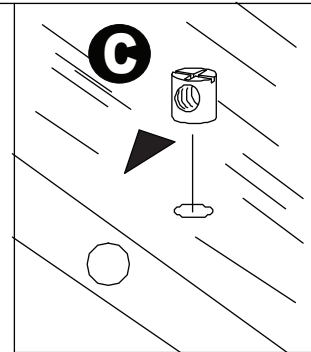
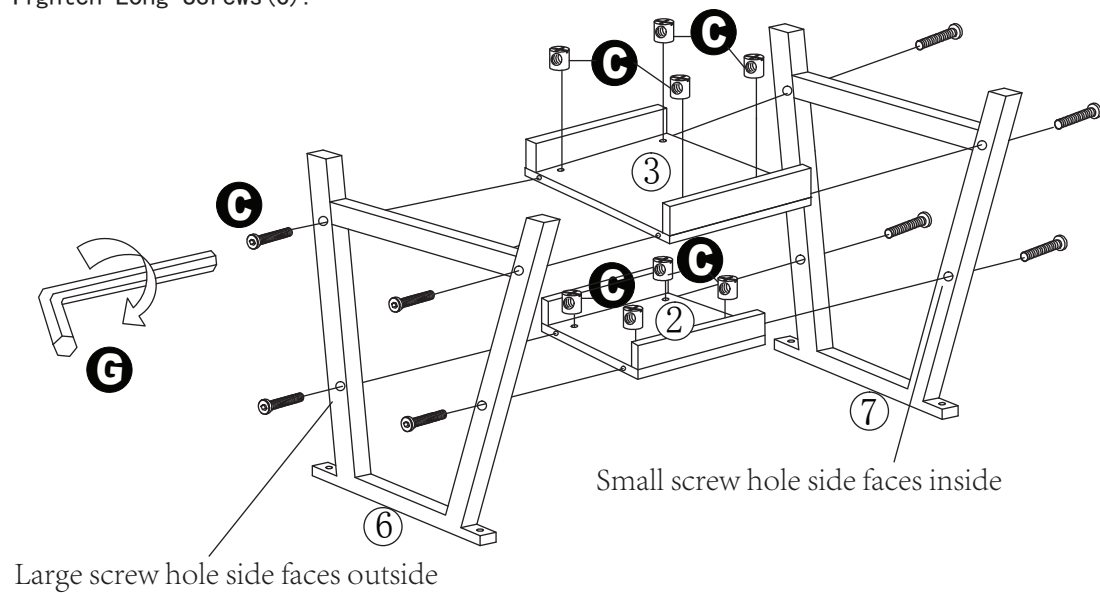
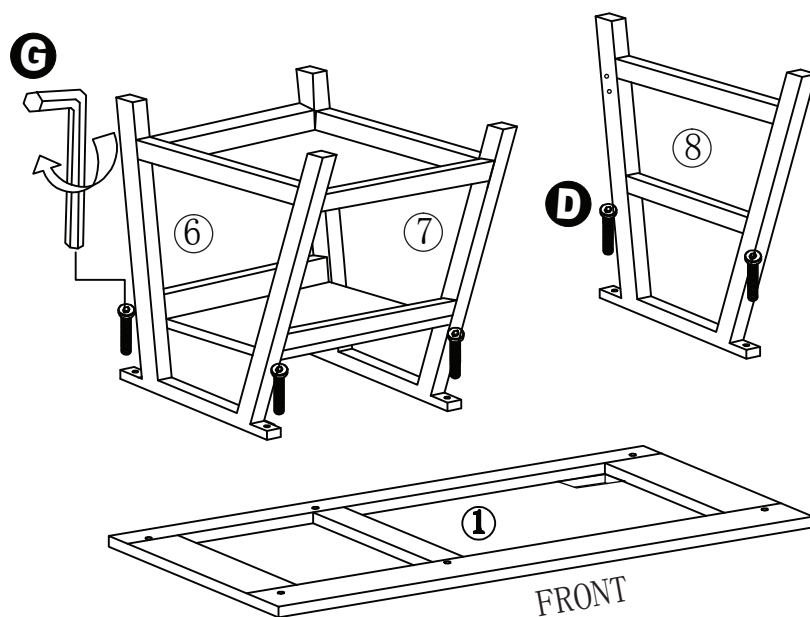

Diagram #1



step4

1. Place Desktop on carpet or soft surface.
2. Connect the assembly and Right Frame (8) to Desktop (1).
Tighten Screws (D).



step5

1. Insert Nuts into Support Rail (5) and **make sure Nut hole faces to bolt hole.**
2. Carefully connect Support Rail (5) to Middle Frame (7) and Right Frame (8). (Long Screw (G) goes through the Frame. Line up holes and insert screws.)
Tighten Long Screws (G).

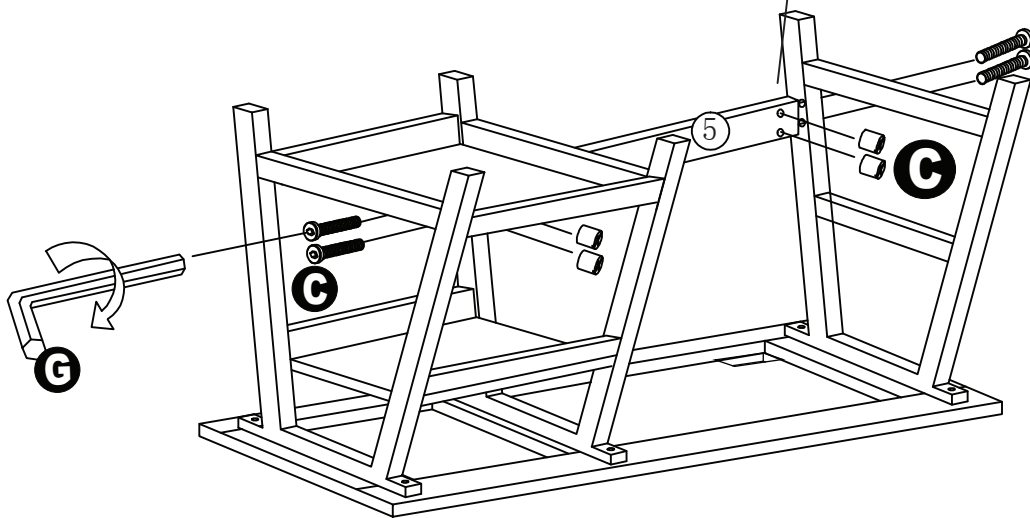
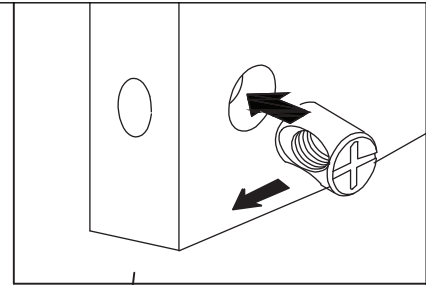

step6

1. Carefully turn the desk.
2. Place hole stickers (F) over screw holes.

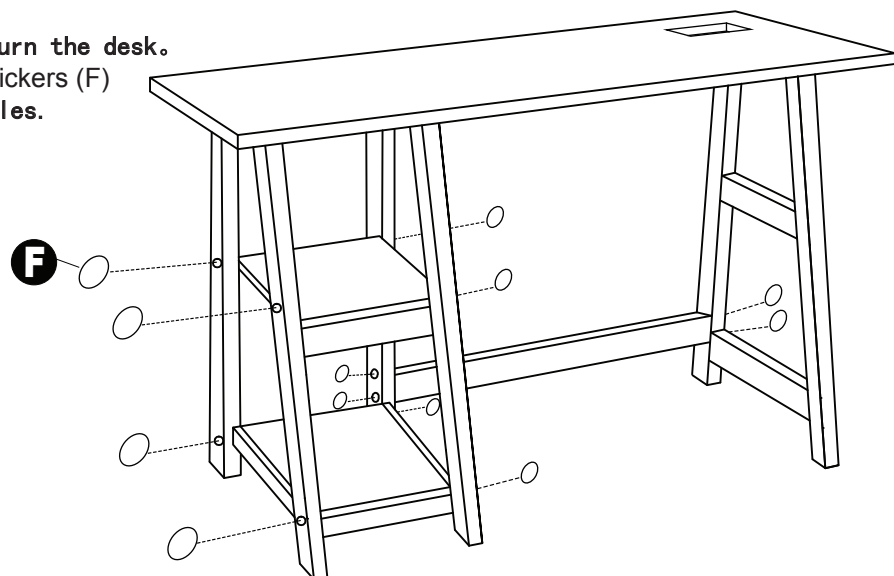

step7

1. Attach Socket Strip (H) to Desktop ① using Small Screws (I) as shown.
2. Enjoy !

