

Owner Manual

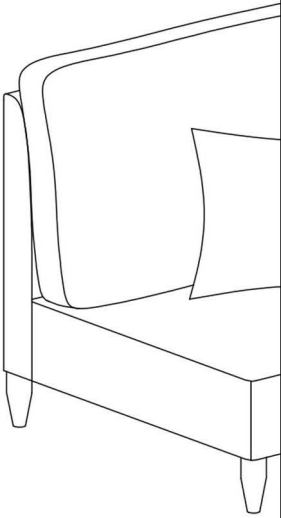

WARRANTY

We strive to offer high quality product and we also try our best to satisfy each customer that order from us, no matter on products or services as needed. Each customer receives a record of their order, such as the order number or item receipt. For any items that are out of warranty period, you may still be able to purchase the replacement parts from our company if they are available.



MAINTENANCE AND WARNING

Please read the manual thoroughly before you start installing.

Please keep the product away from sharp object.

Packaging and small parts may have choking hazard, please keep them away from children and pets.

Please clean the product according to each clean code, check the product description for more information.

Please keep the product away from fire.

If you have any other questions, please contact us, we will be glad to help you out.

If the product is placed under direct sunlight, the pattern or color might fade away overtime.

Check the product periodically to make sure everything is secured and tightened.

Always use proper tools for installation.

Do not jump on the product.

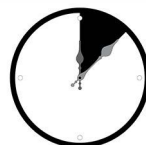

PRODUCT DESCRIPTION

Elegant outlook, presenting a high class feeling in your living room.

Corduroy fabric along with soft foam sponge, become high resilience cushions that offer you high quality relaxation.

Firmly support solid wood legs and metal structure, giving support while long lasting.

Highly customizable, simply connect them with everything we provided, and put them anywhere, anyway you want.

Easy assembly, come with all the tools you need, enjoy the sofa in a moment.

EXPLODED VIEW

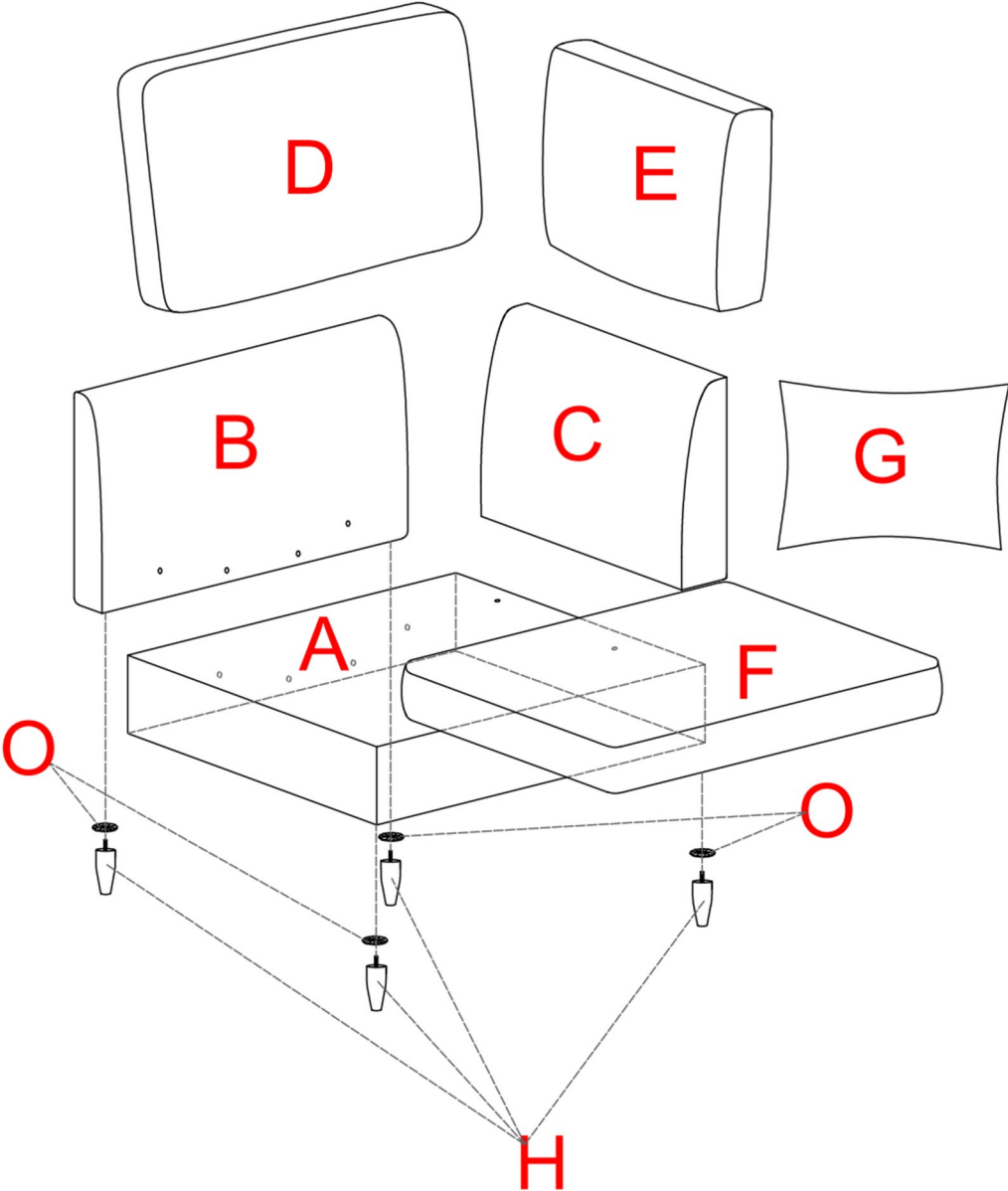

PARTS

A*1

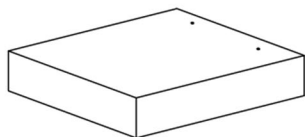

SOFA FRAME

B*1

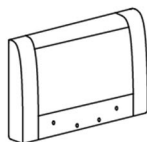

BACK FRAME

C*1

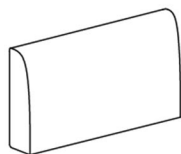

ARMREST FRAME

D*1

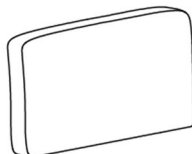

BACK CUSHION

E*1

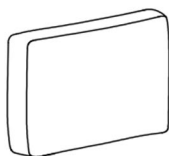

ARMREST CUSHION

F*1

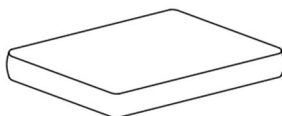

SEAT CUSHION

G*1



PILLOW

HARDWARE

TOOL LIST

NOTE: Designated with (★) We provide additional spare parts in the hardware package

H*4



Legs

I*1



Hook

J*6

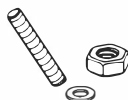

★ Screw&shim&Hex nuts
One of them is a backup

K*1

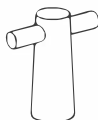

Heagon socket
wrench

O*4



Plastic washer

Please make sure all hardware & packing material fitting the list. Especially some small accessories may be missing during transportation. Please contact us if you have any question.

step 1 ---Cut the plastic air compression bags

After taking out the cushions (F&D&E) from the air compression bags, please allow them to recover for a period of time. It may take up to 48 hours to fully recover. You can gently slap them to speed up the process.

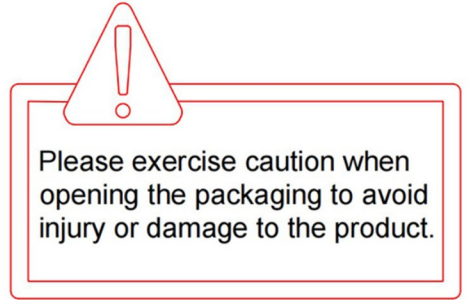
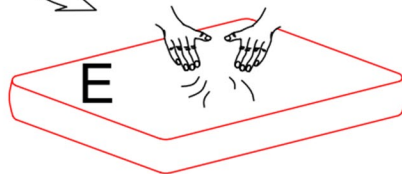
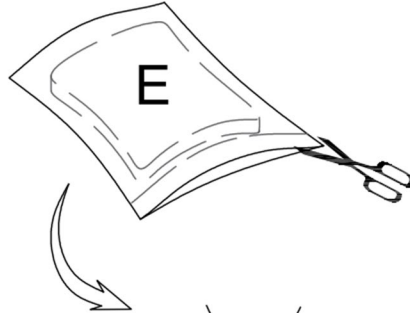
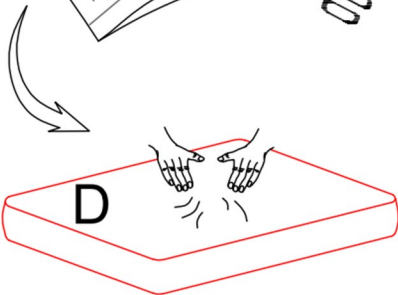
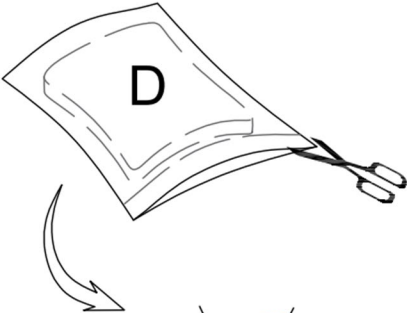
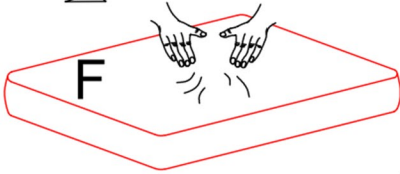
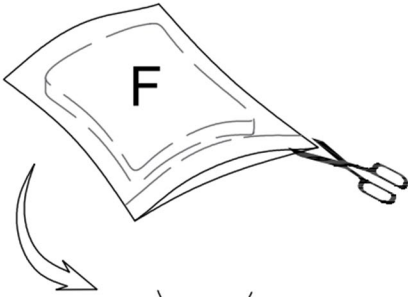

step 2 ---Install the legs (H)

Screw the legs (H) and plastic washer (O) into each hole on seat frame (A) as shown, make sure the are tightented.

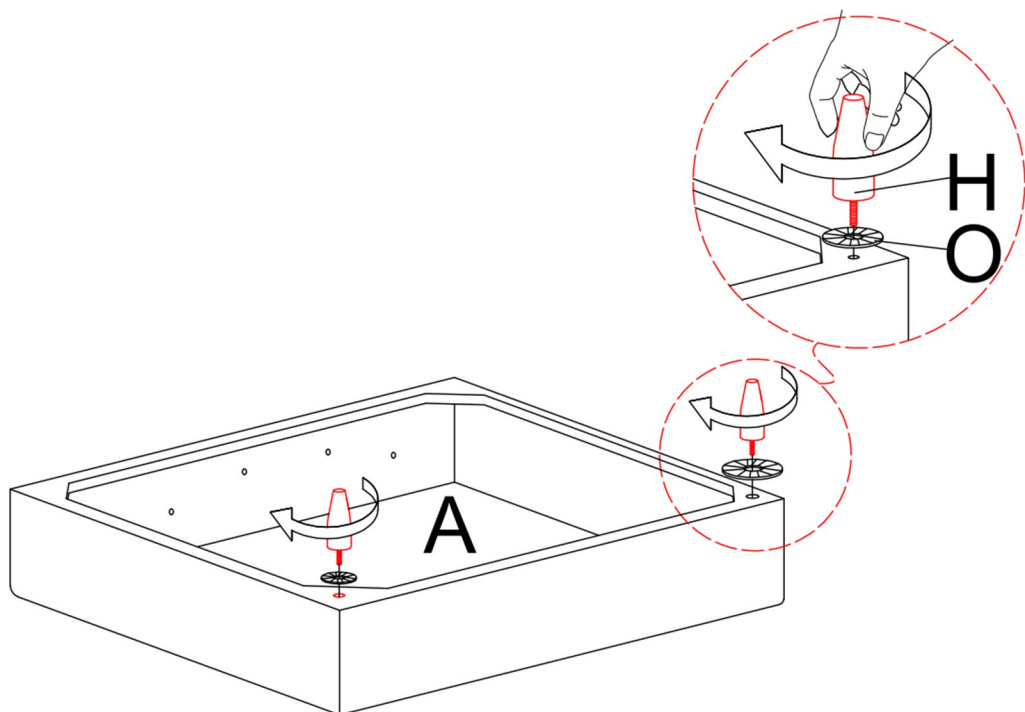

step 3 ---Install the legs (H)

Screw the legs (H) and plastic washer (O) into each hole on back frame (B) as shown, make sure the are tightented.

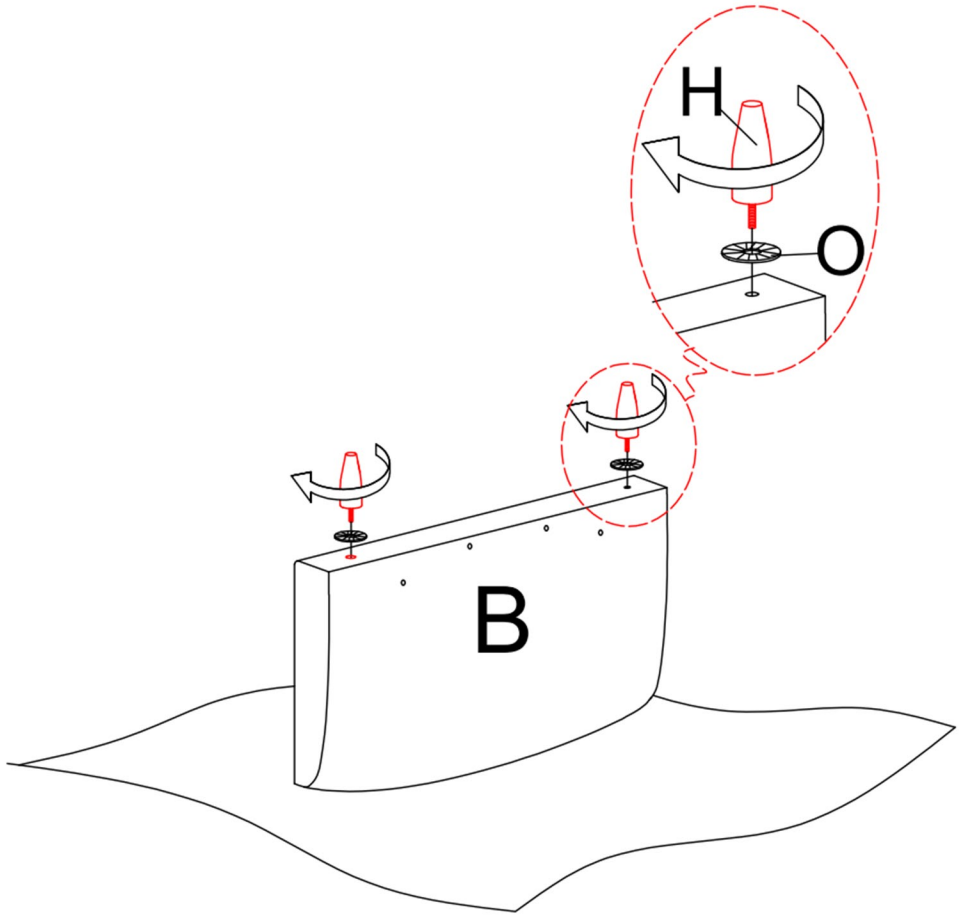

step 4 ---Pre-assembled screw (J)

Align the screws into the pre-drilled holes on the backrest (B), then use hand to twist the screws (J) for 1/3 of their length as shown.

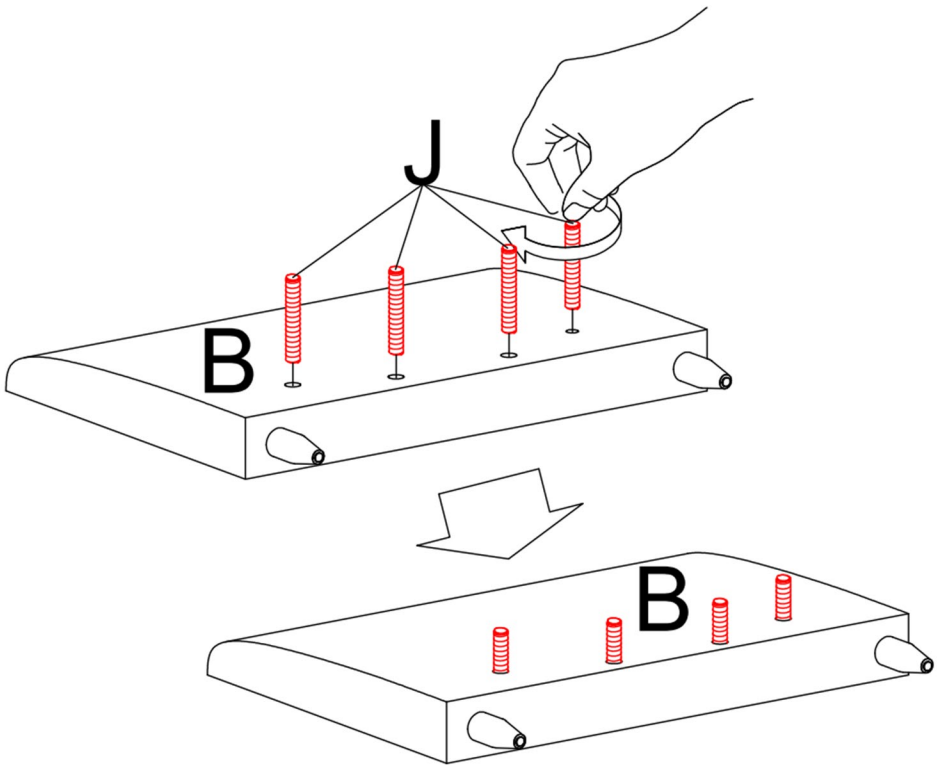

step 5 ---Attach the seat frame to back frame(B)

First, align the designated holes on the seat frame (A) with the screws on the backrest (B) from the last step as shown. Then place one hex nut (J) onto each screw (J), use the hexagon socket wrench (K) provided to tighten both nuts.

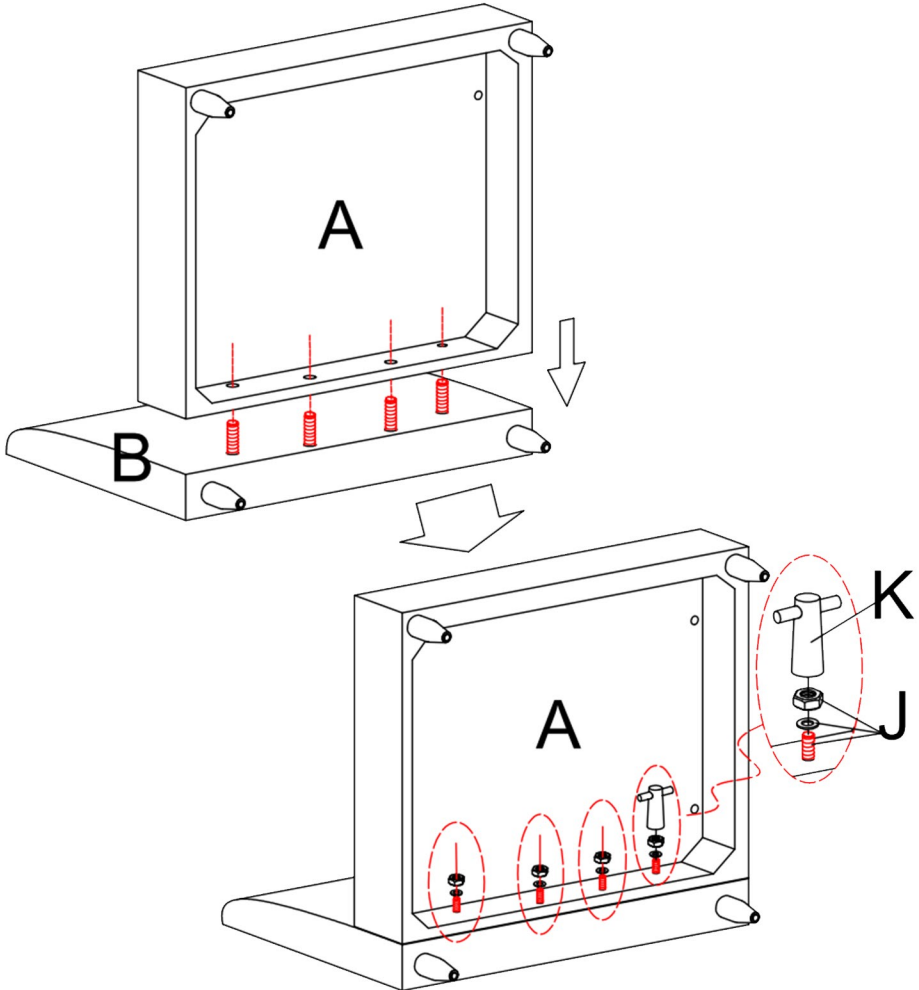

step 6 ---Pre-assembled screw (J)

Align the screws into the pre-drilled holes on the armrest (C), then use hand to twist the screws (J) for 1/3 of their length as shown.

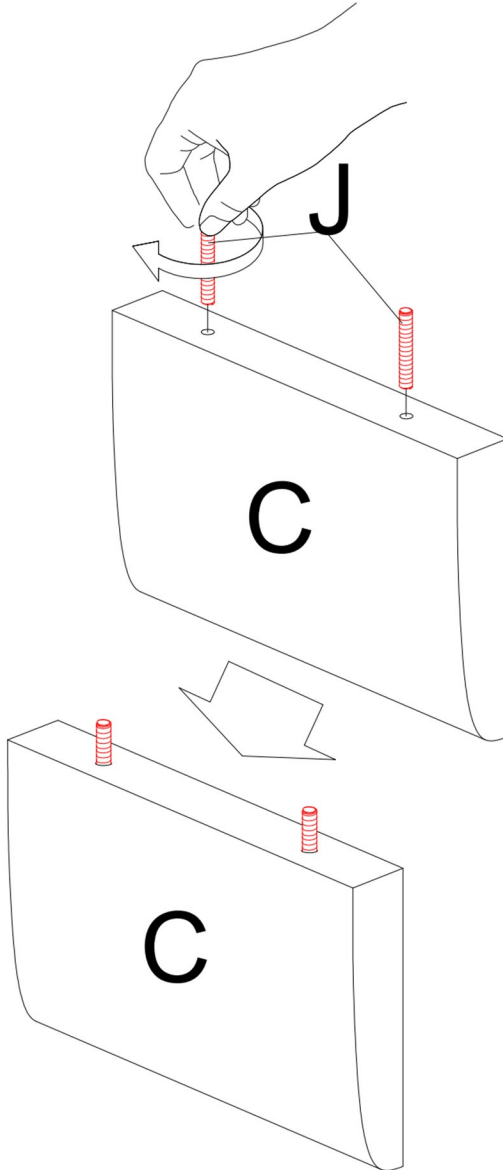

step 7 ---Install the armrest (C)

First, align the designated holes on the seat frame (A) with the screws on the armrest (C) from the last step as shown. Then place one hex nut (J) onto each screw (J), use the hexagon socket wrench (K) provided to tighten both nuts.

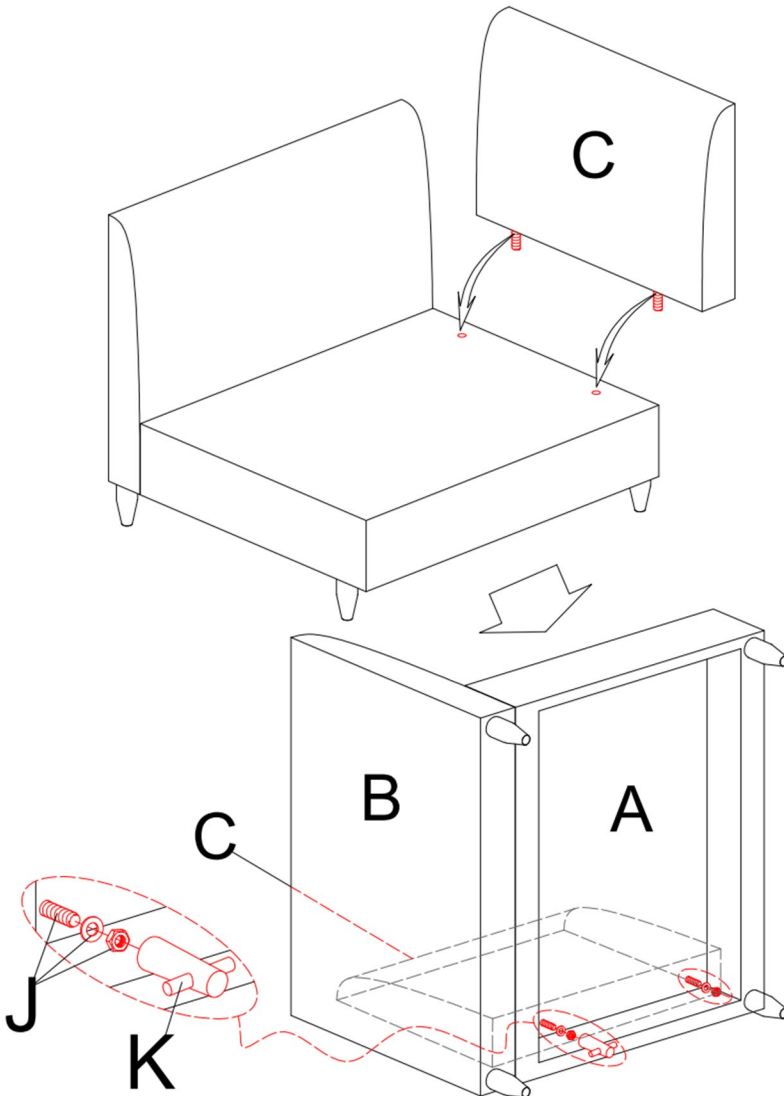

step 8 ---Place the seat cushion & back cushion

Place the seat cushion (F) & back cushion(D) on to the sofa.

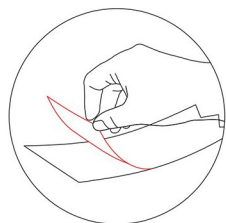

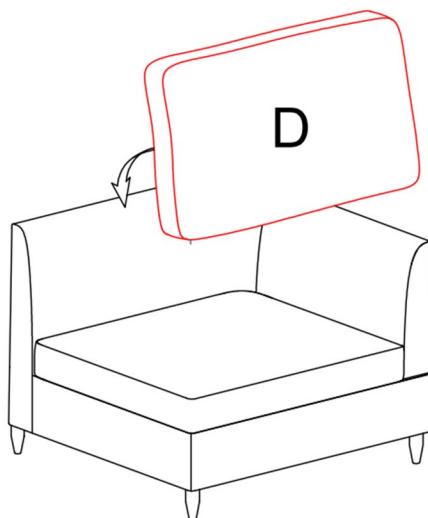
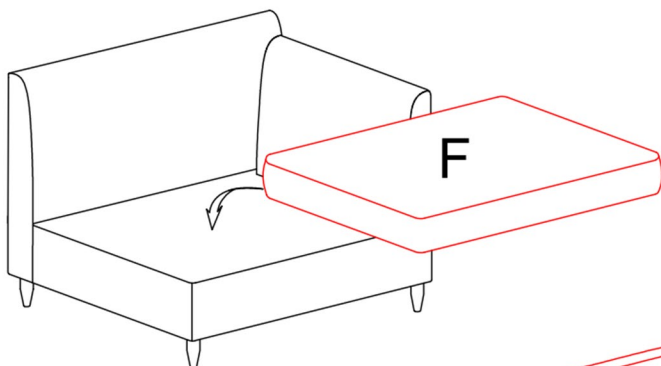

Tear off the Velcro strip cover before pasting.

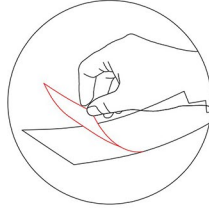

step 9 ---Place the arm cushion

Place the arm cushion (E) & pillow (G) on to the sofa.



Tear off the Velcro strip cover before pasting.

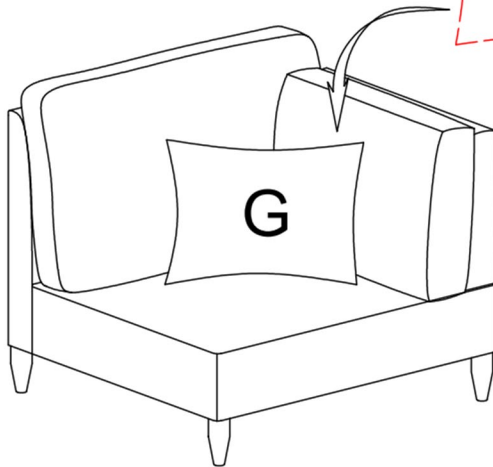
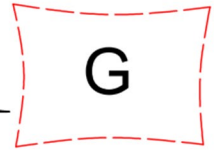
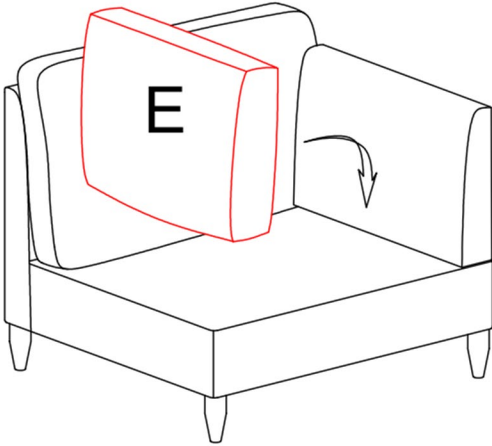

step 10 ---The usage method of metal hook

There is a metal hook inside the carton as a free part.

If you only purchased single part of the sofa, this hook will not be useful.

If you want to be combined with other sofa components (ottoman, chair, chaise etc), this hook can be used. Just use this hook to fix two parts together from the bottom to prevent displacement while using the products.

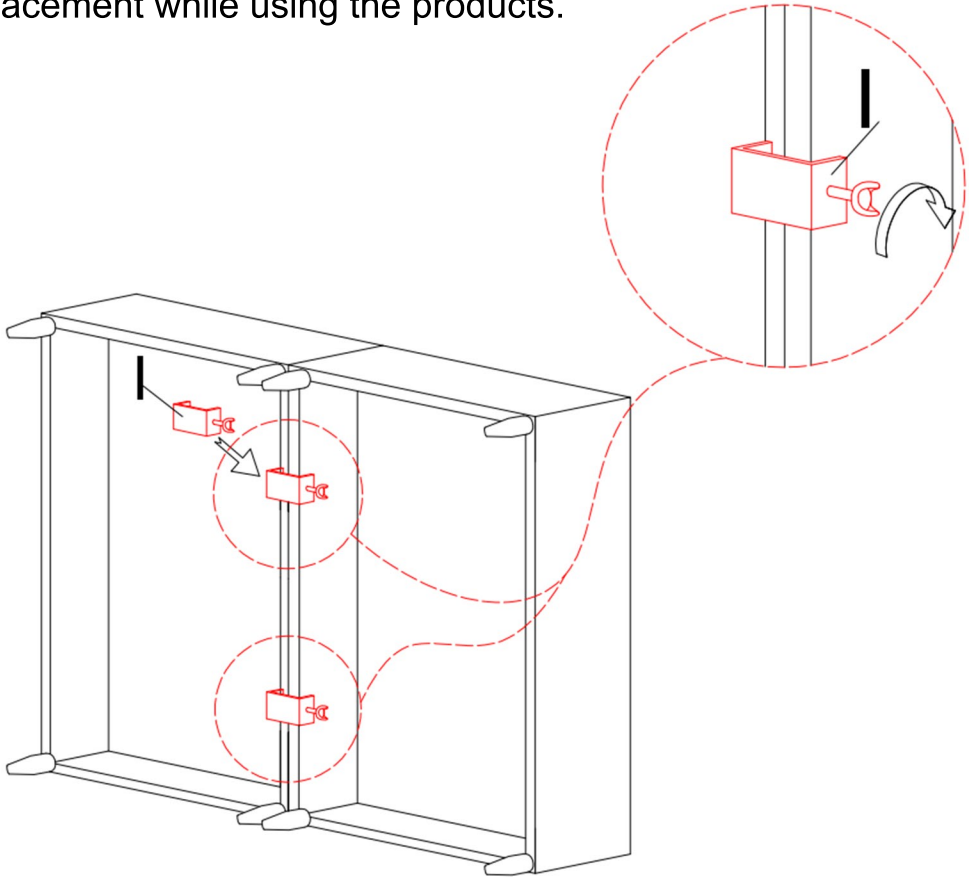

step 11 ---Assemble complete

Congratulations! You have finished the assembly, thank you again for choosing our product! Please enjoy!

