

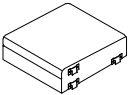

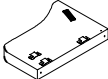





wayfair® **Assembly Instruction**

CHAIR

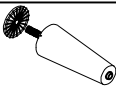
Note: Do not use power tools for assembly. Power tools increase the risk of over tightening which lead to splitting or cracking the wood.

Component list

No	Drawing	Qty	Description
A		1	SEAT
B1		1	LSF ARM 1PC
B2		1	RSF ARM 1PC
C		1	BACK REST
D		1	SUPPORT BAR
E		4	WOODEN LEG/W PLASTIC WASHER
F		2	BOLT (#1/4"*35mm)
G		2	FLAT WASHER (#1/4"*16*1.5mm)
H		1	ALLEN KEY (M4*59mm)

Step #1

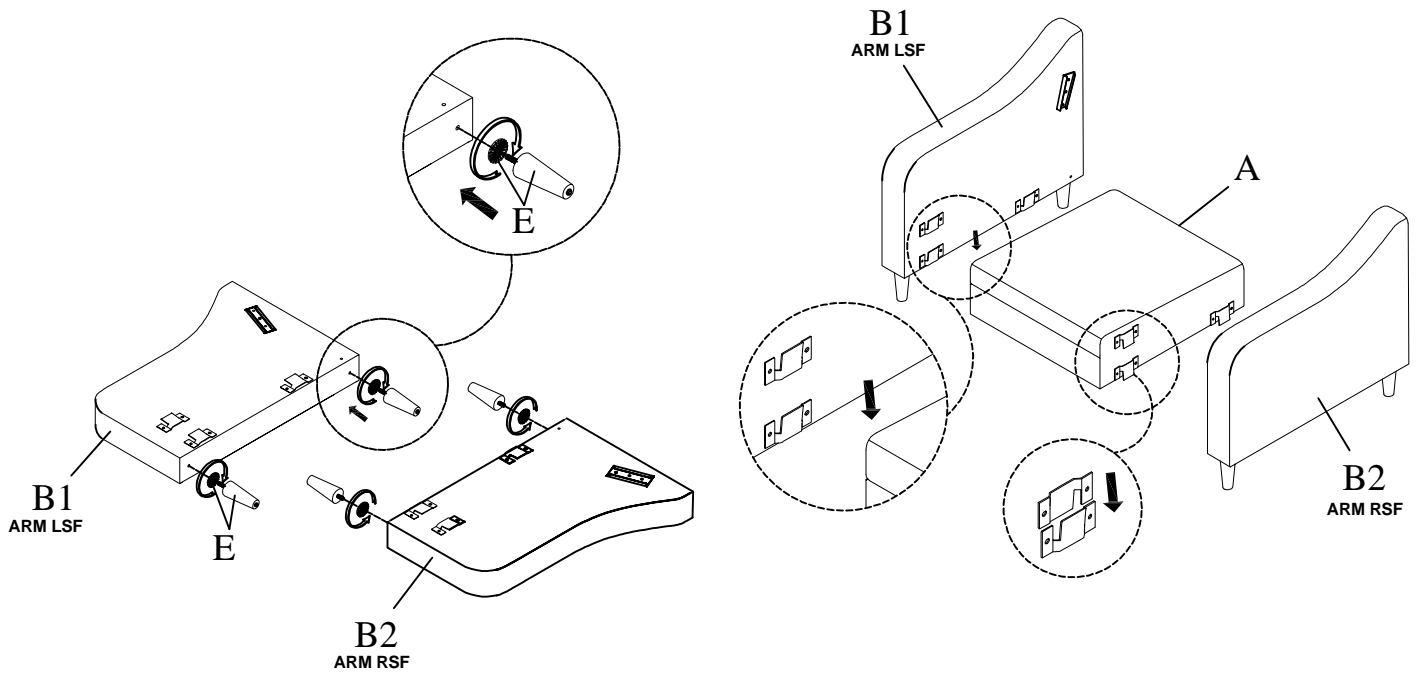

Step #2

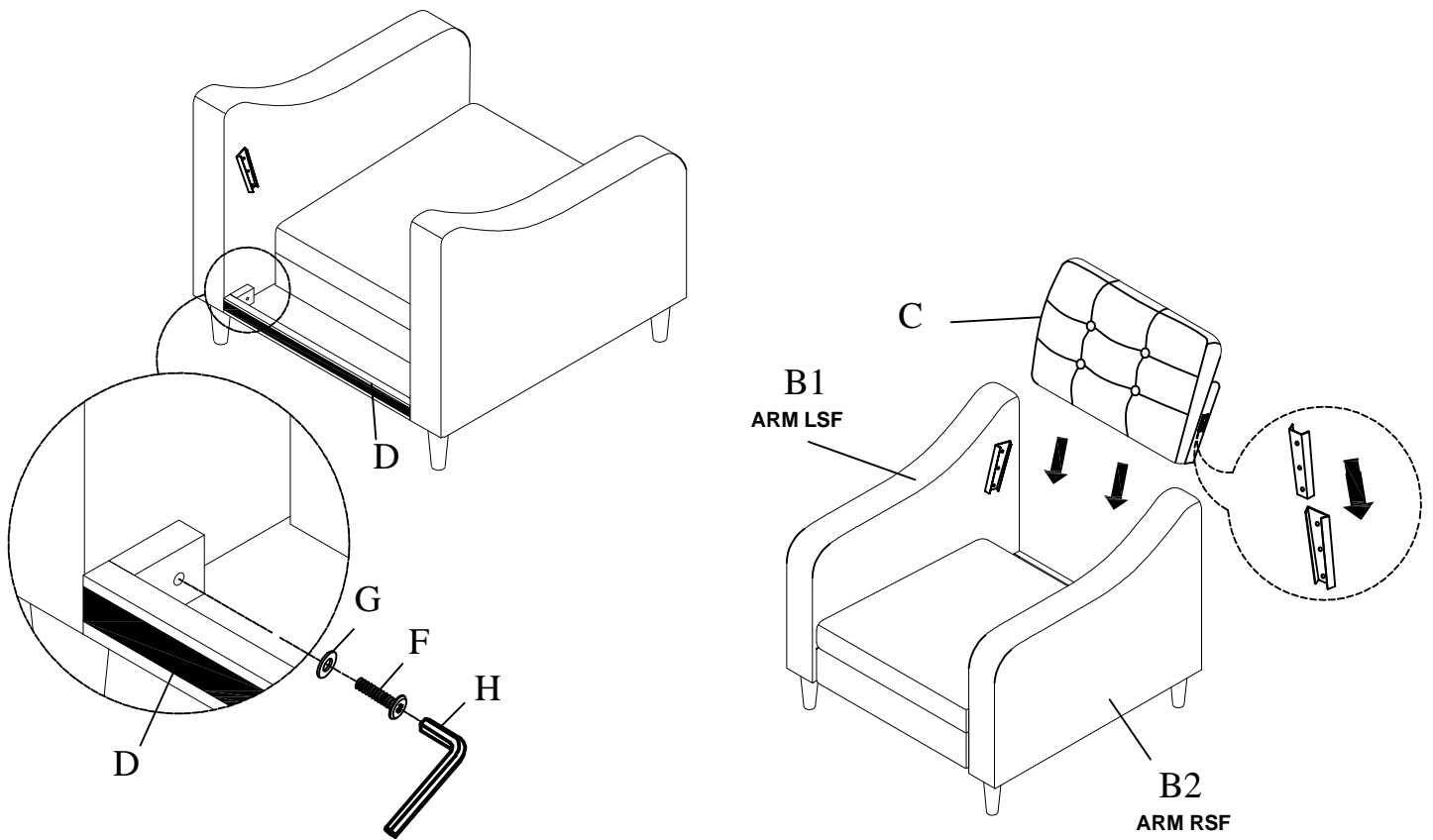

Step #3

Assembly completed.

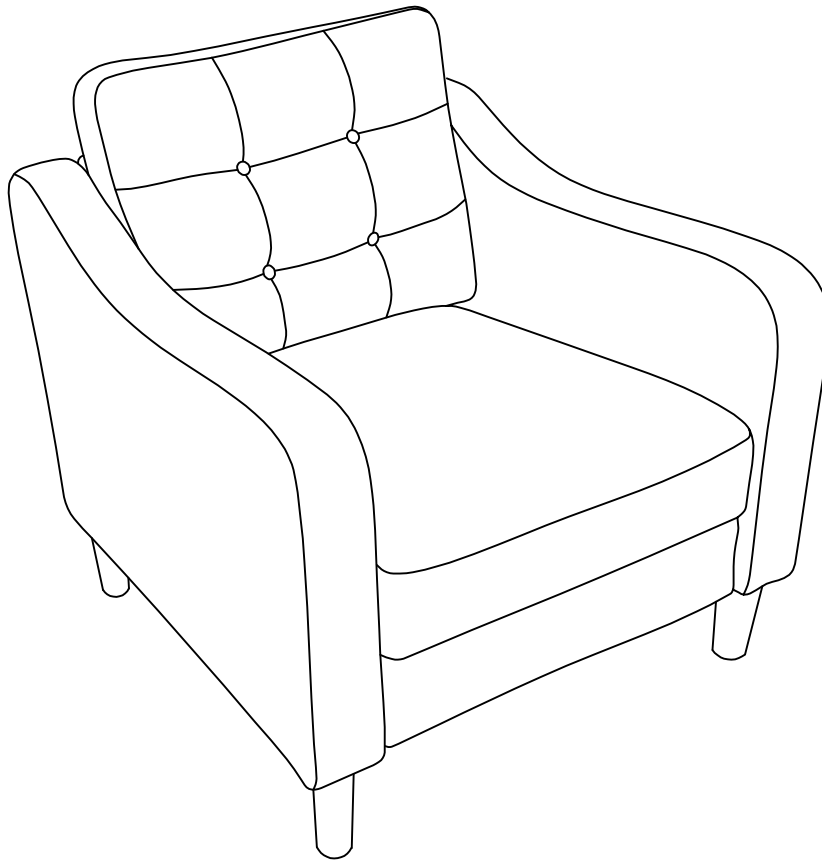

Care Instruction for fabric Furniture:

In order to maintain the original appearance of your fabric Furniture, please follow below simple care procedures:

- Avoid exposing furniture directly to sunlight or heating and air conditioning outlets. Sunlight and/or exposure to heating and air conditioning outlets will fade/damage fabric. Do not place your fabric furniture too close to windows, radiators, or vents, and be sure to use windows, radiators, or vents.
- Vacuum or wipe with a soft cloth to remove dust.

Hardware may loosen over time. Periodically check to make sure all connection are tight, Re-tighten if necessary.



For items use on wooden floor, hard surfaces or carpets, it is recommended to Install protective pads under all legs and supports to avoid/prevent from damages/scratches and discoloration.