



Please read the instructions carefully before using the product.



CAUTION

- Warning: Please cut off the power before installation to avoid

Disconnect the Power Supply Before Installation

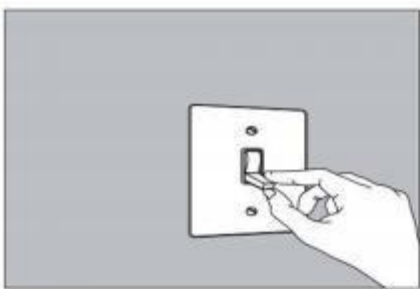

FIG. 1.
Place the wall switch to the "OFF" position Depending on which type of fuse box you have in your home.

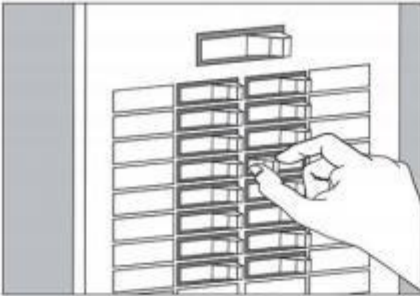

FIG. 2.
Place either the main (Master) switch to the "OFF" position, cutting off power to your entire home OR turn off the individual switch that provides power to where the fixture will be installed.

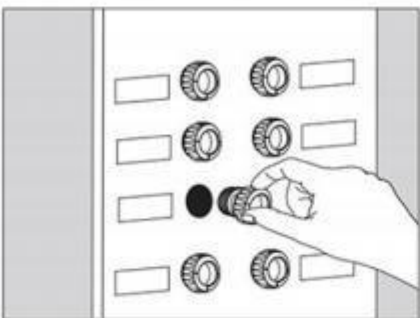
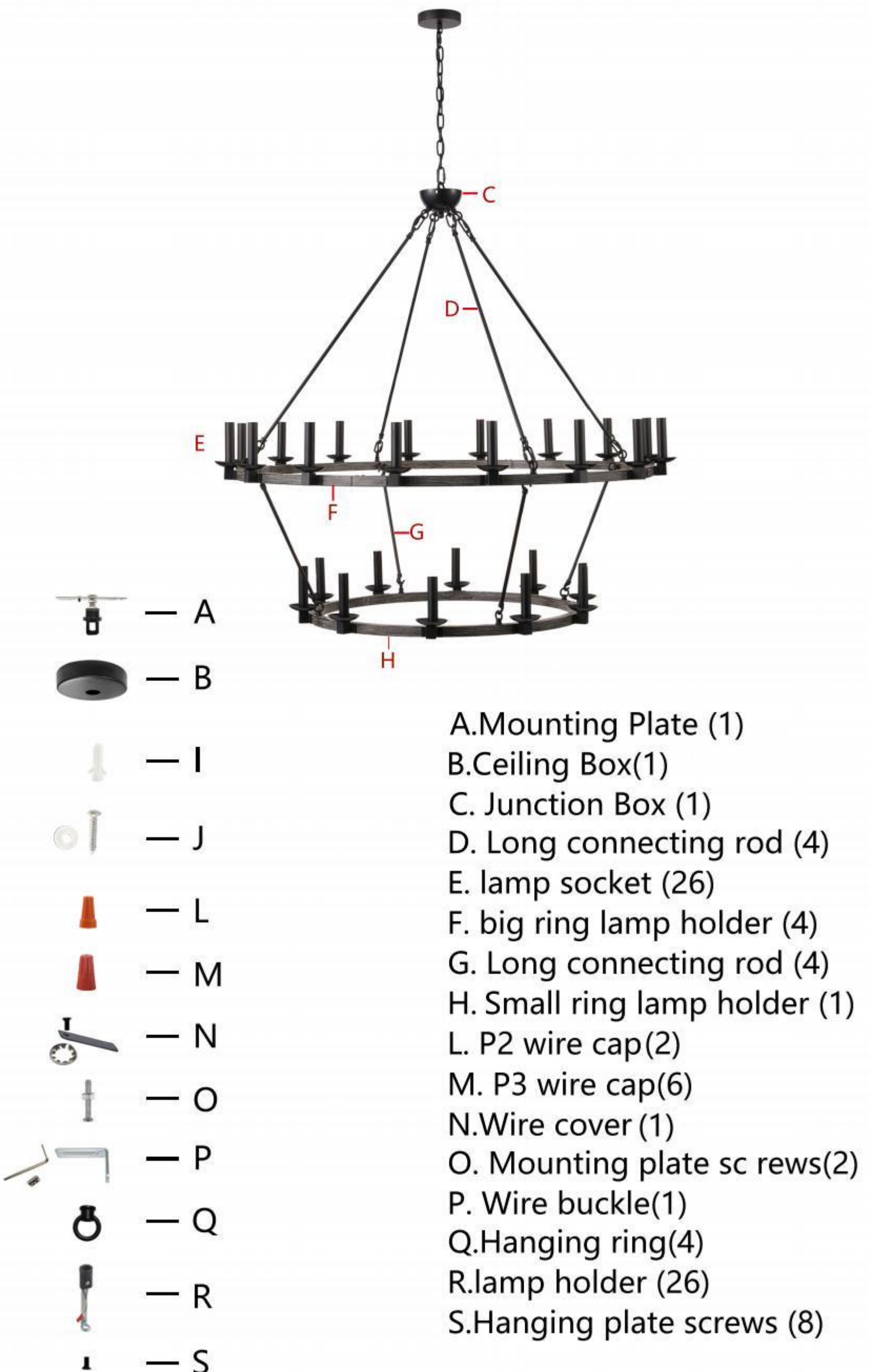

FIG. 3.
Place either the main (Master) switch to the "OFF" position, cutting off power to the entire home OR unscrew the fuse that provides power to where the fixture will be installed.

Parts Included



Safety Information

Please read and understand this entire manual before attempting to assemble, operate or install the product.

1. For your safety, it is strongly recommend that two people install the lighting fixture.
2. We strongly recommend a professional electrician to install it.
3. This product must be installed by personnel familiar with the structure and operation of the product and associated risks in accordance with applicable installation specifications.
4. Please ensure to cut off the power before maintenance, installation, and replacement of the bulb.
5. Keep clean during installation to prevent scratches on the surface of lamps and wires.
6. In order to prolong the service life of the chandelier, the environment should be ventilated and dry.
7. Turn the power to fixture off before replacing bulbs, making sure the bulbs have sufficient time to cool down.
8. The bulb should not exceed the maximum wattage indicated on the fixture.

- Remove all parts and hardware from the box along with any plastic protective packaging.
- Do not discard any contents before the assembly is complete to avoid accidentally discarding small parts or hardware.

Installation Steps

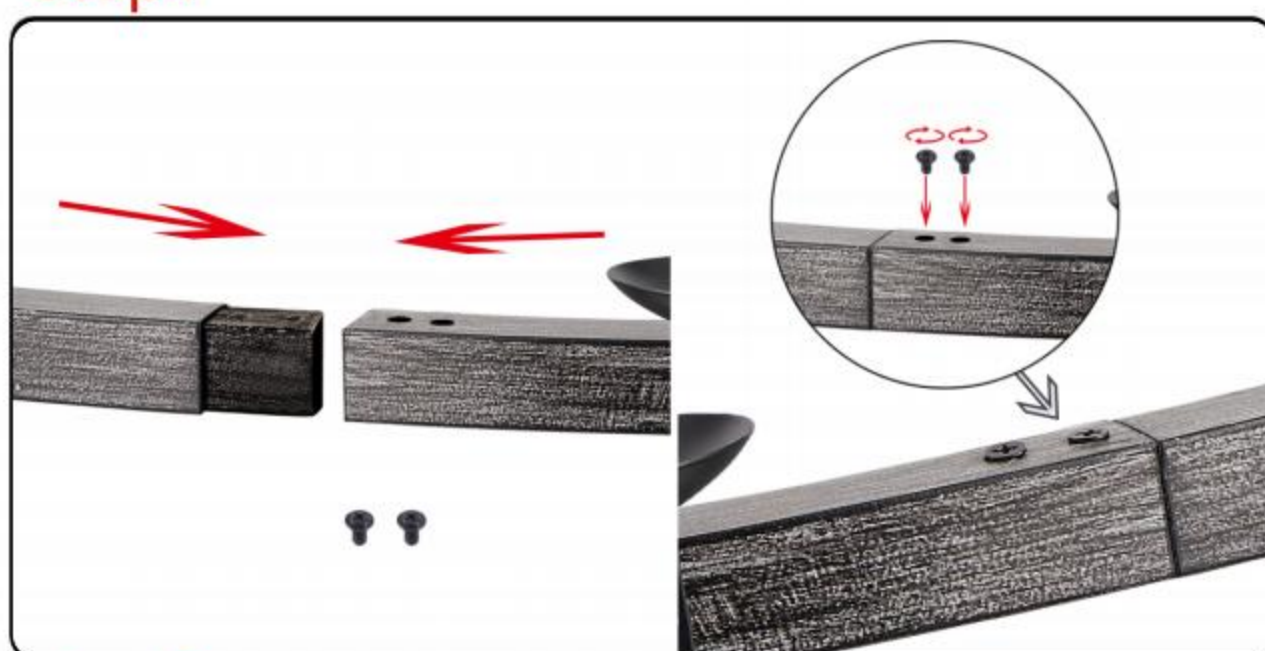
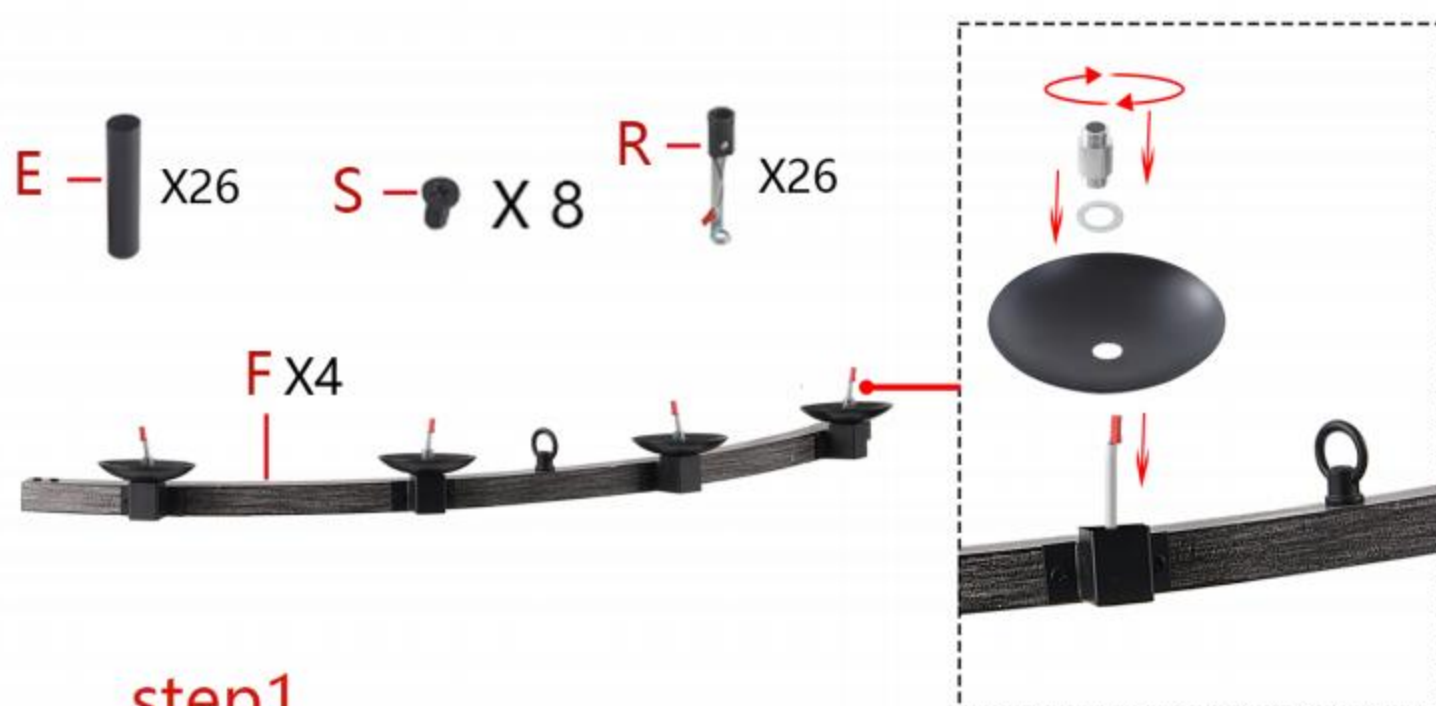

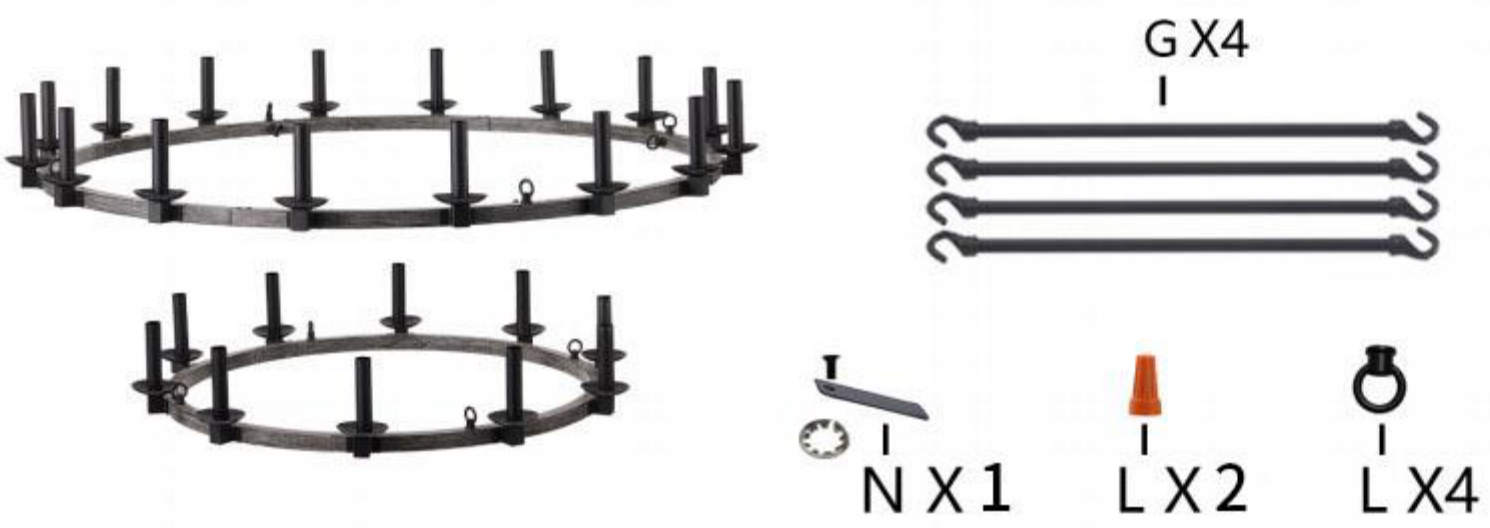

step1

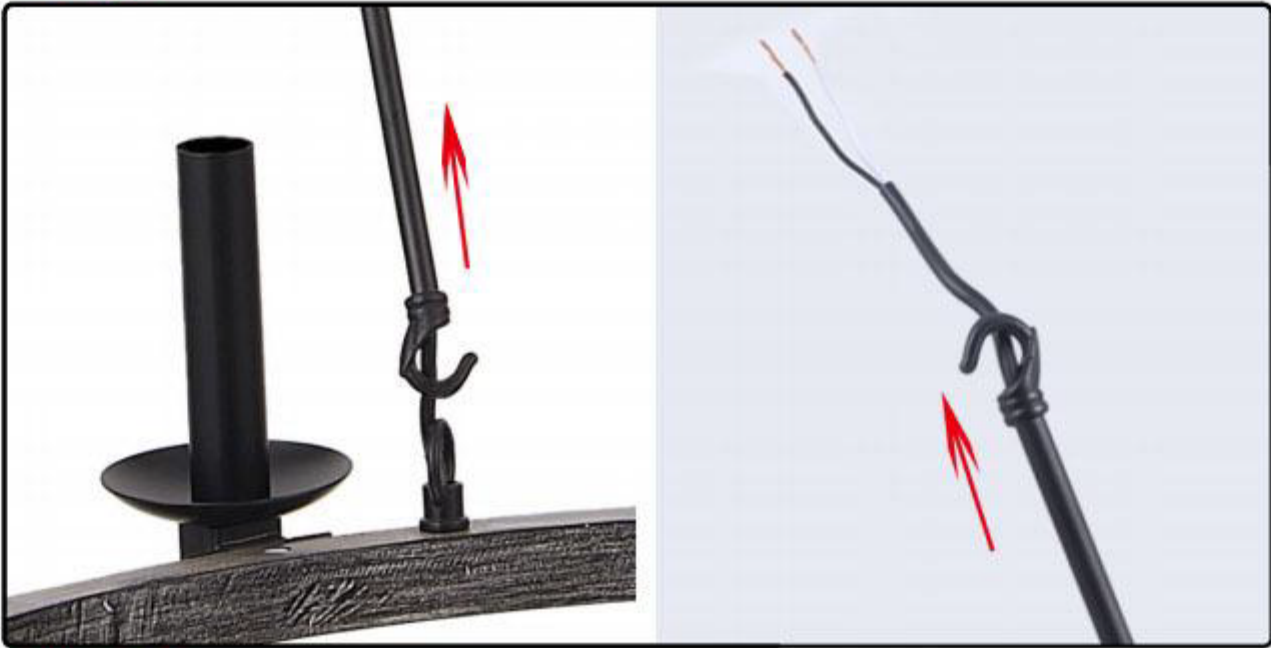

step2



step3

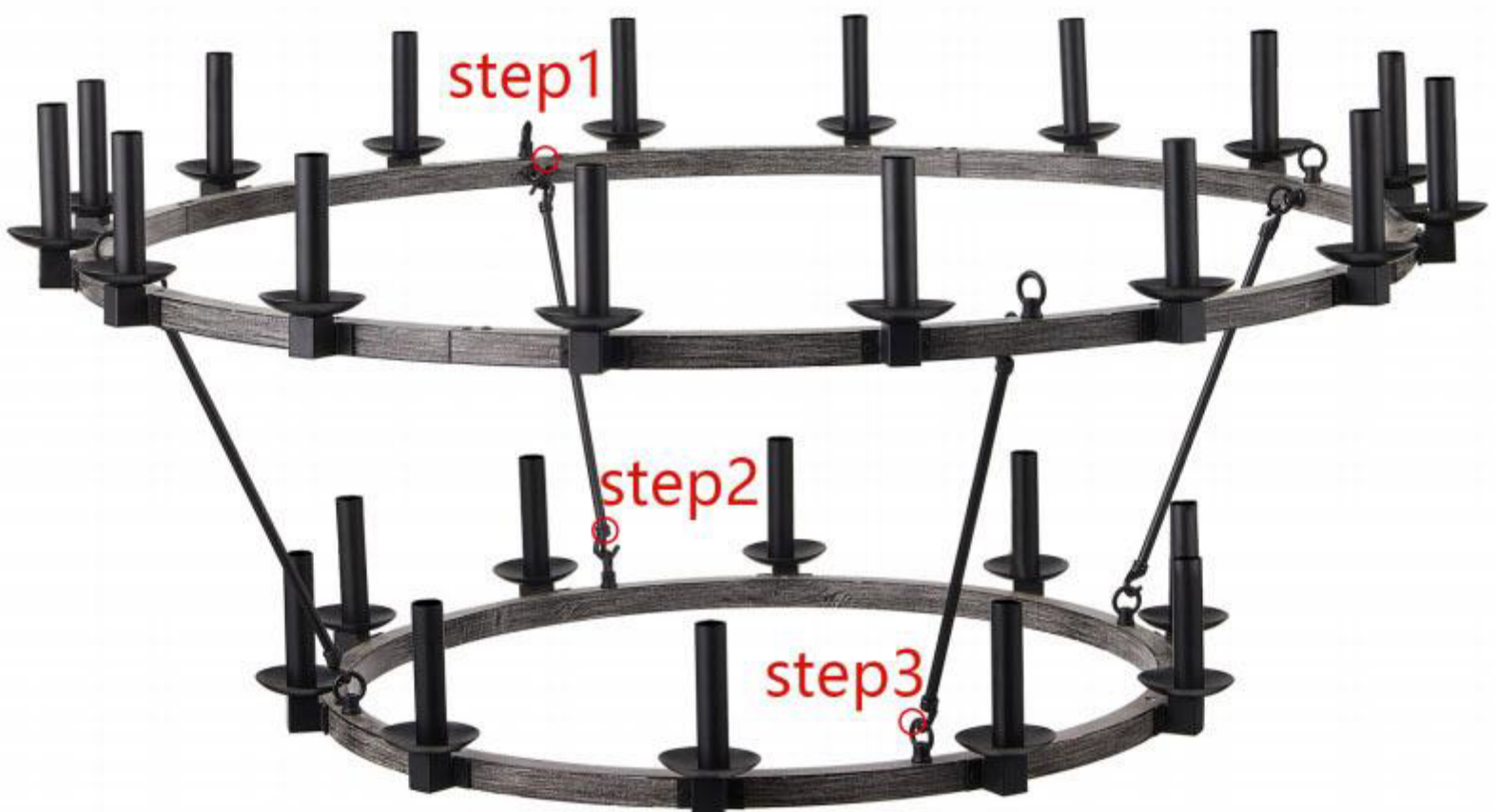
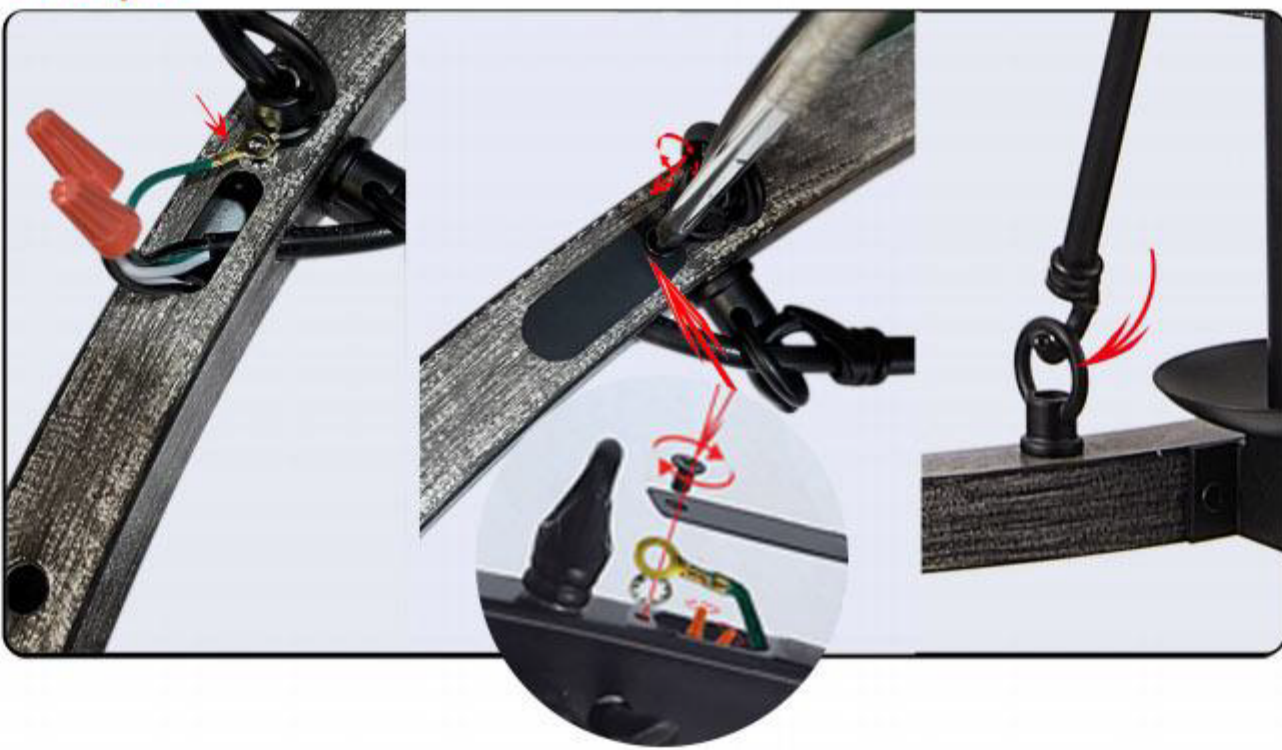



D X4

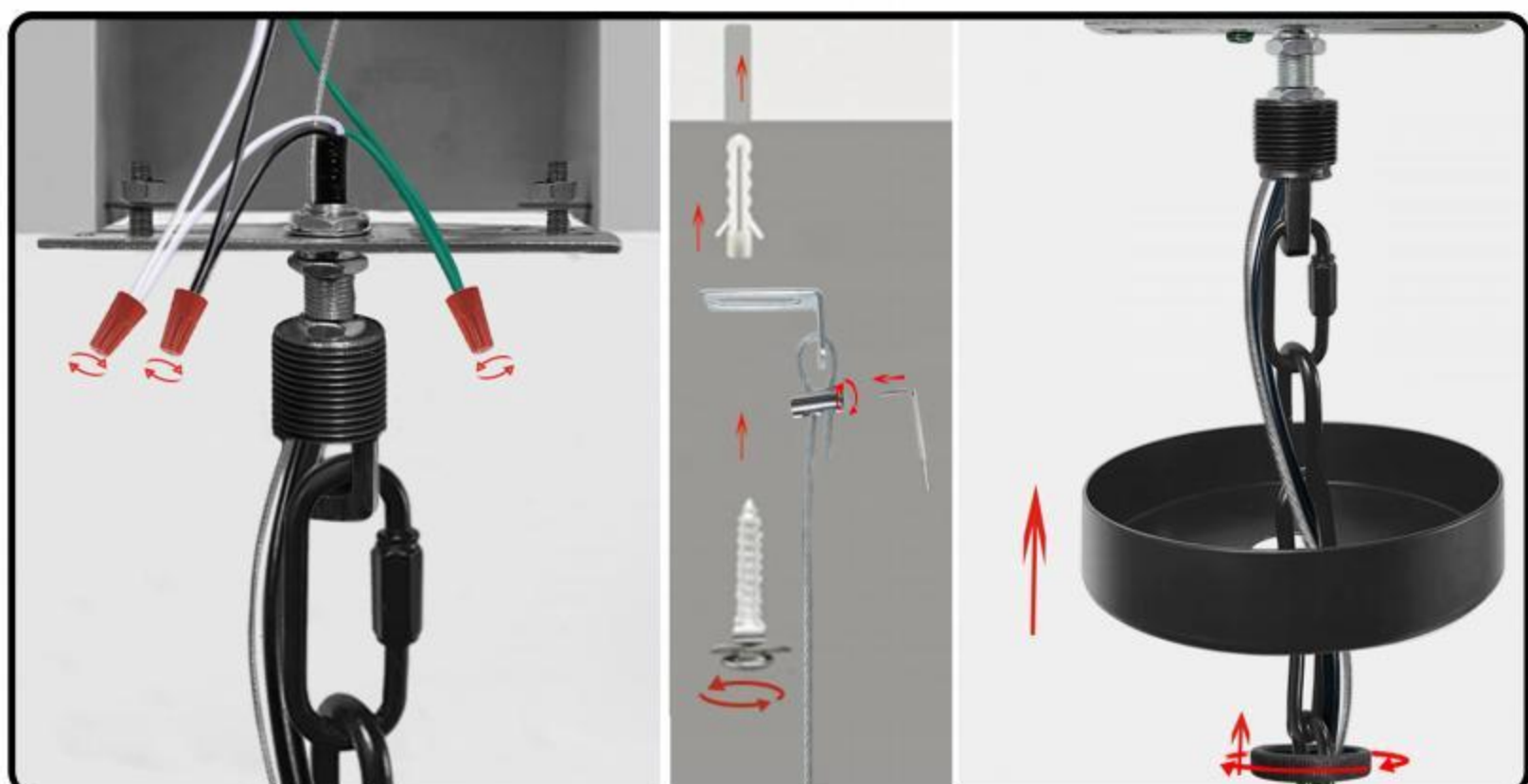
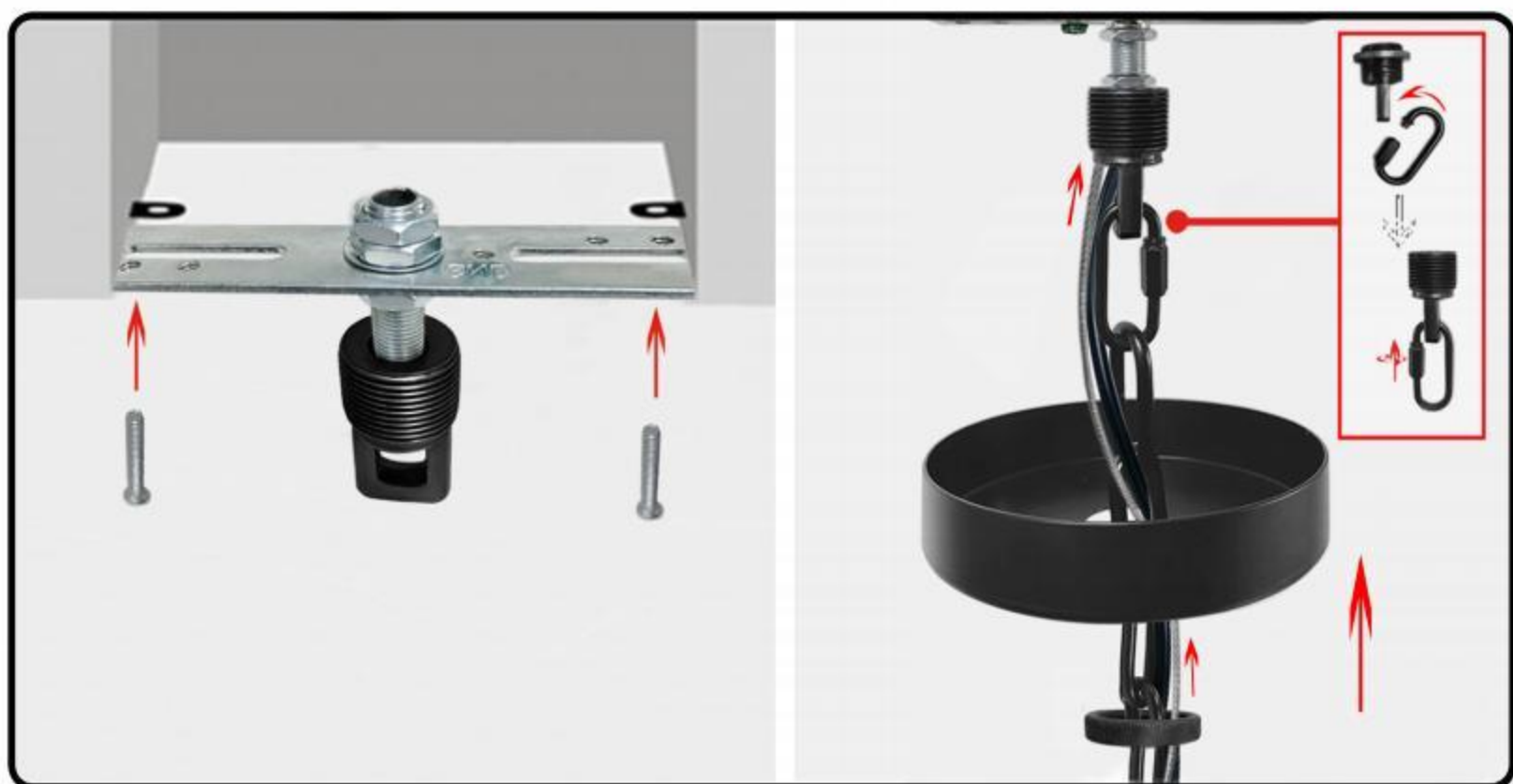
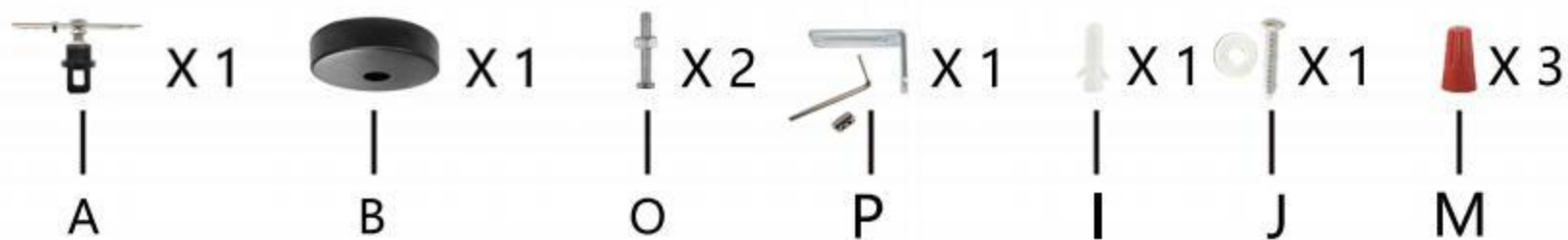
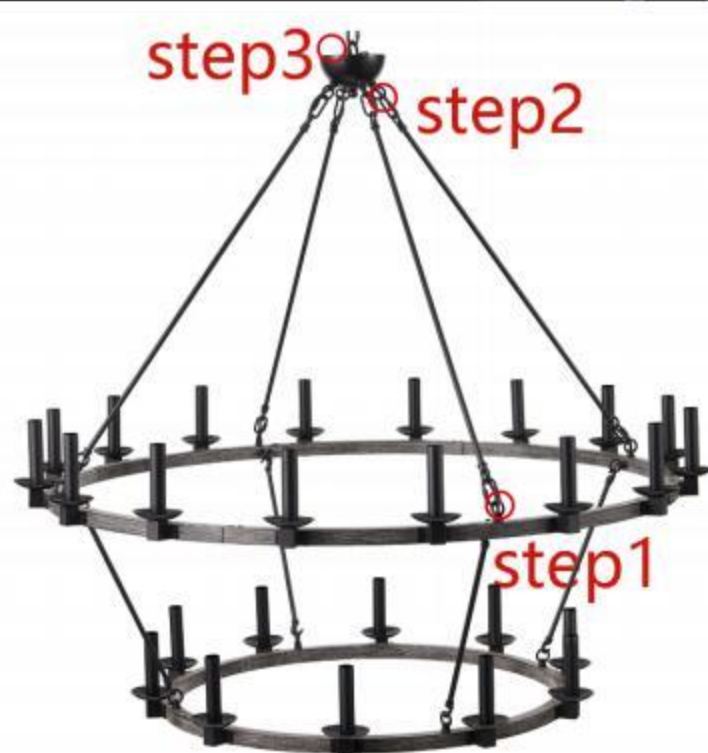
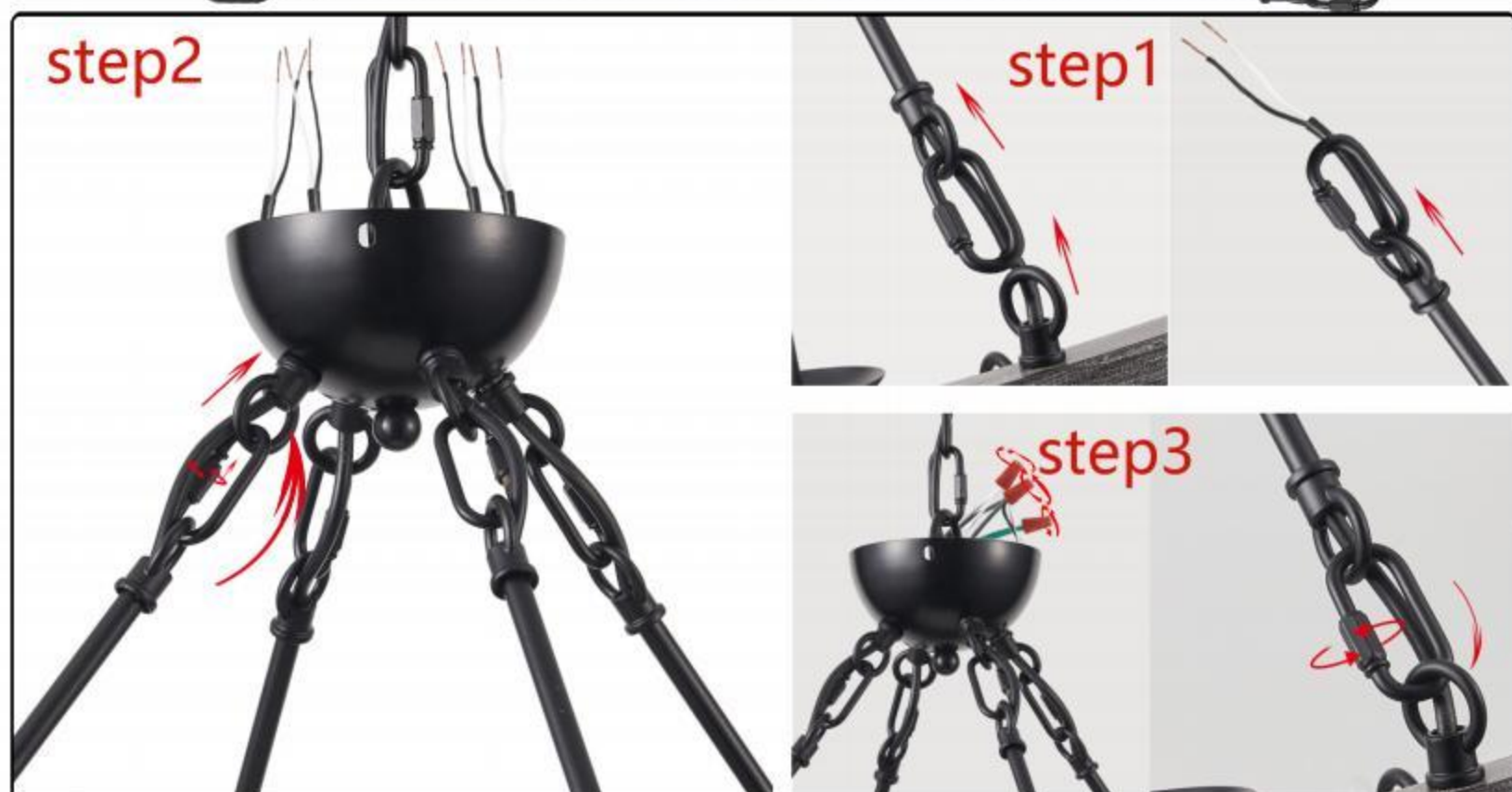
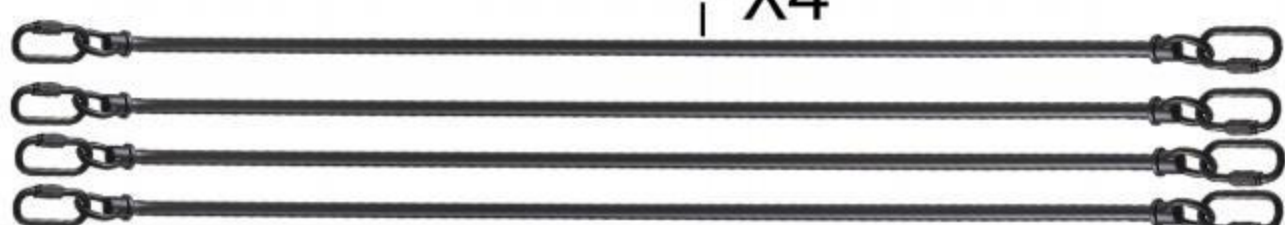



Return/Exchange Policy

To be eligible for a return, your item:

- Must be initiated within 30 days of receiving order
- Must be unused, unaltered, undamaged and in the manufacturer's box and packaging
- Must have not been installed (No clipped wires)
- Must have all tags, accessories, and original package
- Must not be furniture and painted

Note

We would not be able to accept returns that are Defective/Damaged/Incorrect in account of customers' responsibility.