

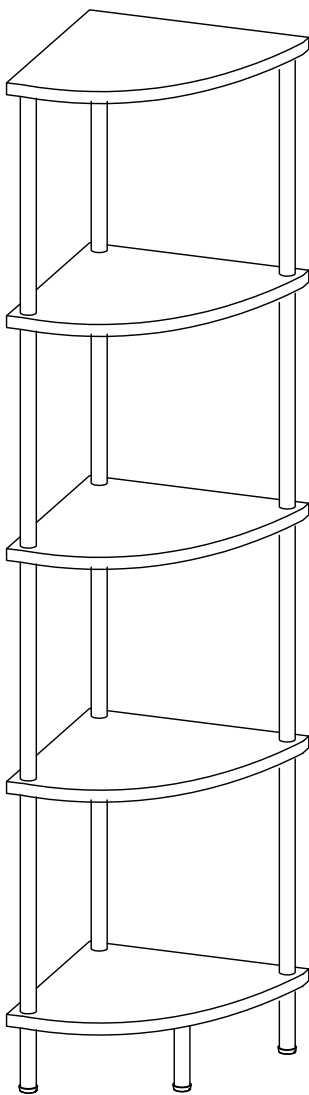

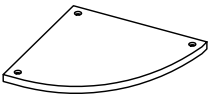

ASSEMBLY INSTRUCTIONS

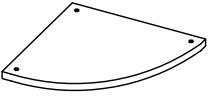
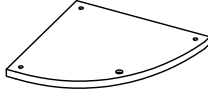

Parts List

<p>①</p>  <p>X1</p>	<p>②</p>  <p>X3</p>	<p>③</p>  <p>X1</p>	
<p>Ⓐ</p>  <p>X3</p>	<p>Ⓑ</p>  <p>X1</p>	<p>Ⓒ</p>  <p>X9</p>	<p>Ⓓ</p>  <p>X3</p>
<p>Ⓔ</p>  <p>X4</p>	<p>Ⓕ</p>  <p>X1</p>		

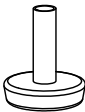
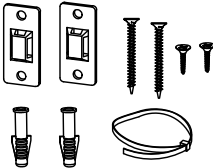
STEP 1

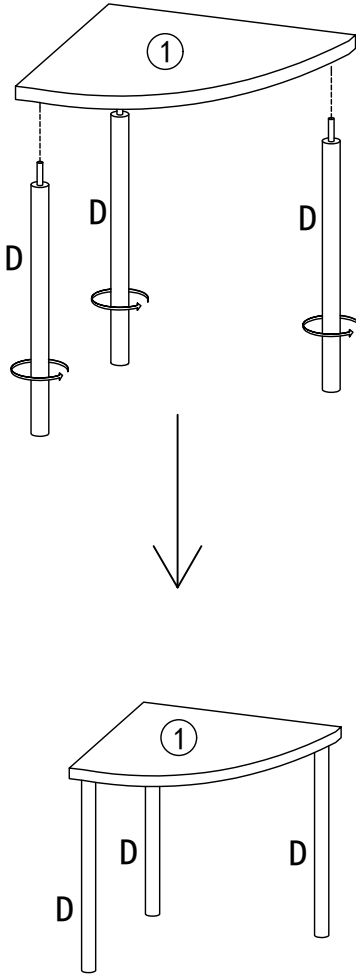

D*3

STEP 2

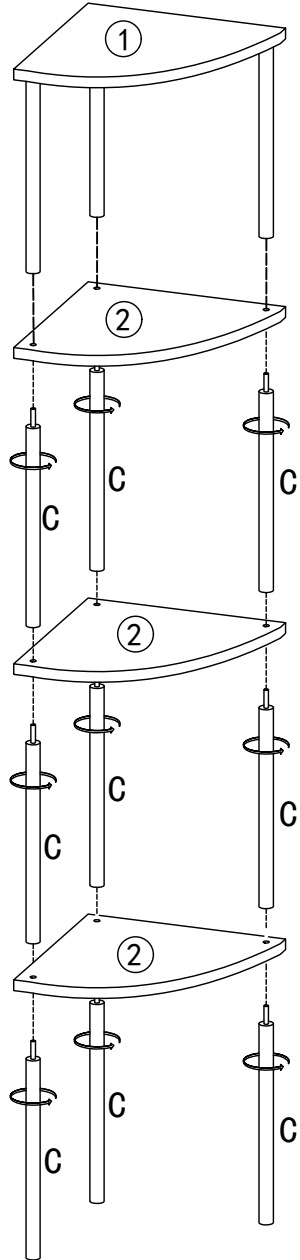

C*9

STEP 3

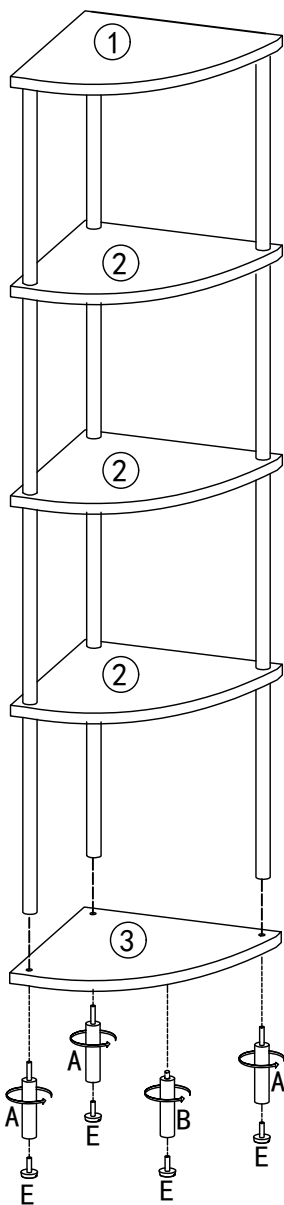

A*3 B*1
E*4

STEP 4

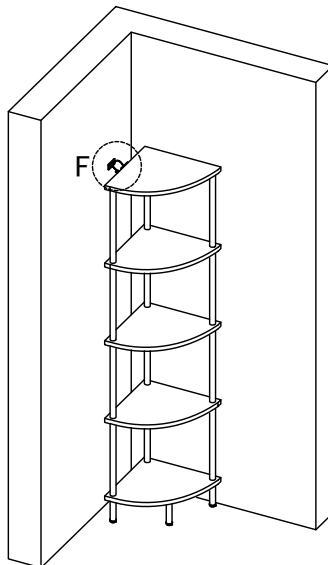

STEP 1

Install the latch on the wall.

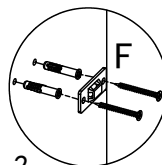

STEP 2

Install the latch on the board.

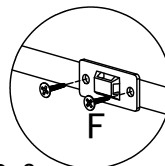

STEP 3

Put on Fall Preventing Belt.

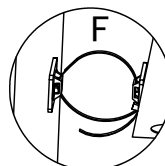

F*1