



# ASSEMBLY INSTRUCTION

## RECLINING CHAIR

The Metal pin are all wrapped together and placed on the back of the armrest

**NOTE:** Do not use power tools for assembly. Power tools increase the risk of over tightening which leads to splitting or cracking the wood.

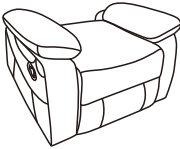
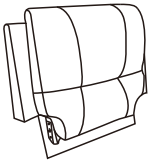
### COMPONENT LIST (CHAIR)

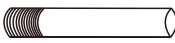
NO.	DRAWING	QTY	DESCRIPTION
A		1	SEAT
B		1	BACK REST
C		1	LSF ARMREST
D		1	RSF ARMREST
E		4	METAL PIN

### STEP# 1

Insert metal pins (E) to the pre-drilled holes on both arms, turn clockwise to tighten it. Attach and insert both arms(C & D) onto the handrail, push to the end and make sure the metal pins is locked in place properly.

### Step#2

Attach Back Rest (B) to the Seat(A)

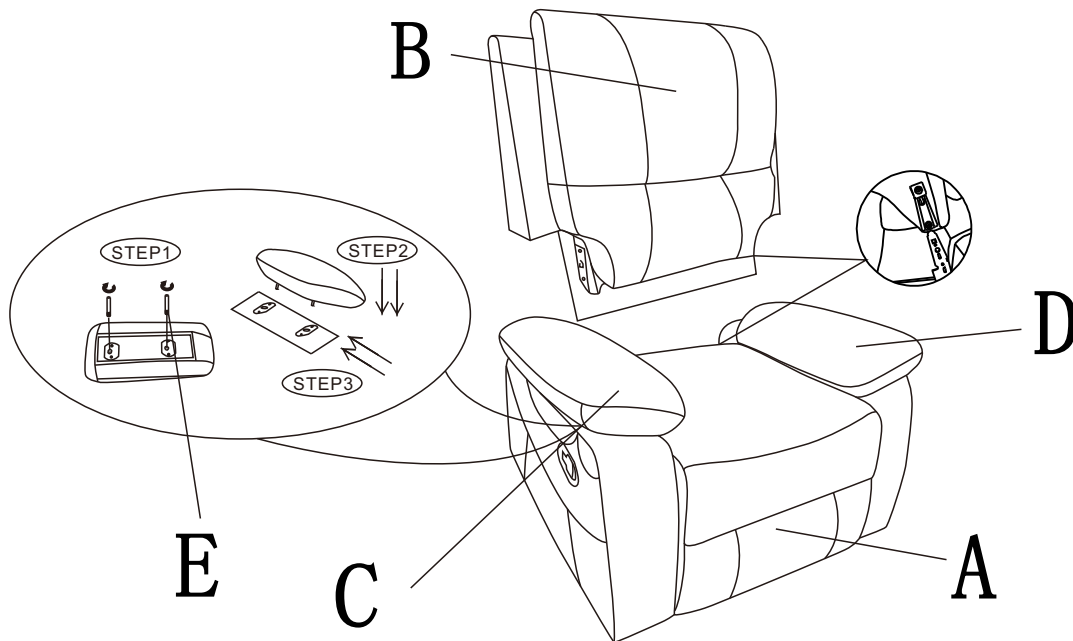

**STEP#3** Completed

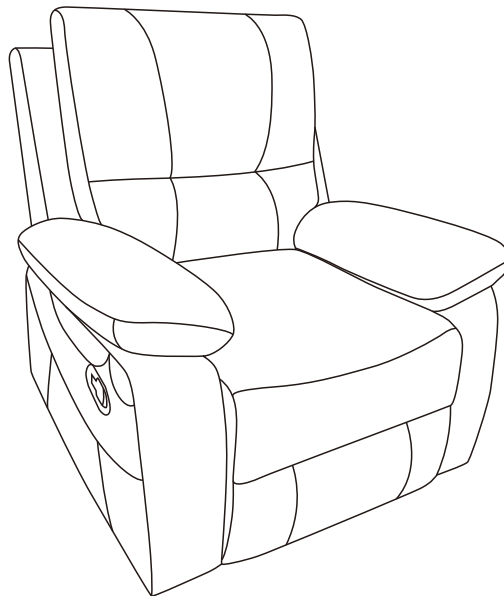

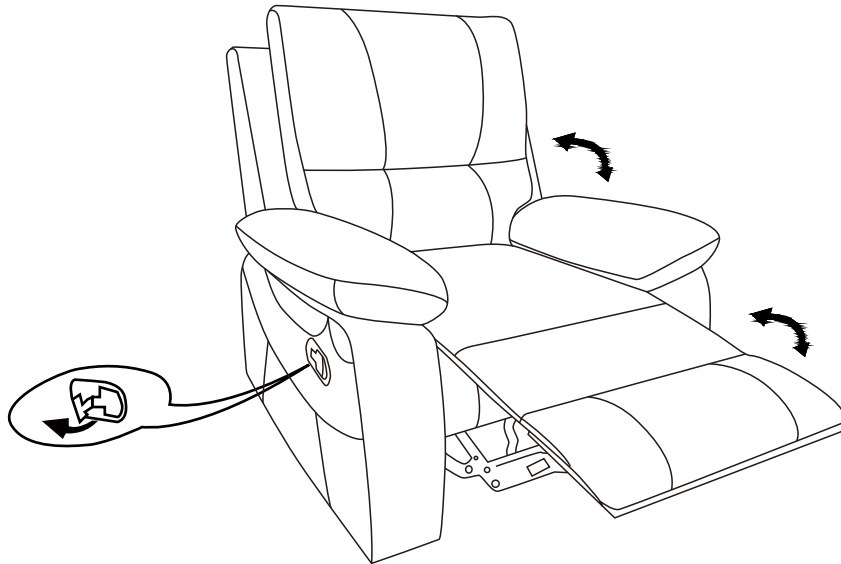

### Care Instruction for PU Furniture.

In order to maintain the original appearance of your PU furniture, please follow below simple care procedures:

- Avoid exposing furniture directly to sunlight or heating and air conditioning outlets. Sunlight and/or exposure to heating and air conditioning outlets will fade/damage PU.
- Do not place your upholstered furniture too close to windows, radiators, or vents and be sure to use window, radiators, or vents.
- Vacuum or wipe with a soft brush to remove dust.







**For items used on wooden floor, hard surfaces or carpets, it is recommended to install protective pads under all legs supports to avoid/prevent from damages/scratches discoloration.**

## **ASSEMBLY INSTRUCTION DOUBLE RECLINING LOVE SEAT**

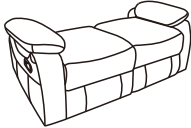
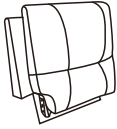
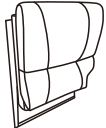
The Metal pin are all wrapped together and placed on the back of the armrest  
**NOTE:** Do not use power tools for assembly. Power tools increase the risk of over tightening which leads to splitting or cracking the wood.

### COMPONENT LIST (LOVE SEAT )

NO.	DRAWING	QTY	DESCRIPTION
A		1	SEAT
B		1	LSF BACK REST
C		1	RSF BACK REST
D		1	LSF ARMREST
E		1	RSF ARMREST
F		4	METAL PIN

**STEP# 1**

Insert metal pins (F) to the pre-drilled holes on both arms, turn clockwise to tighten it. Attach and insert both arms(D & E) onto the handrail, push to the end and make sure the metal pins is locked in place properly.

**Step#2**

Attach LSF Back Rest (B) and RSF Back Rest (C) to the Seat(A)

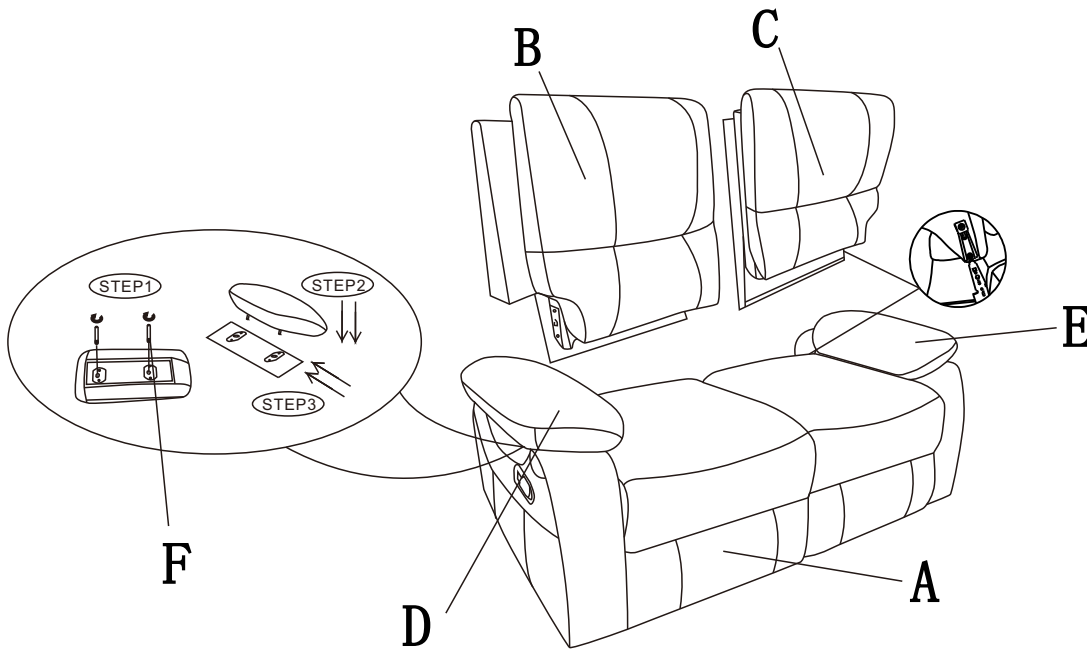

**STEP#3** Completed

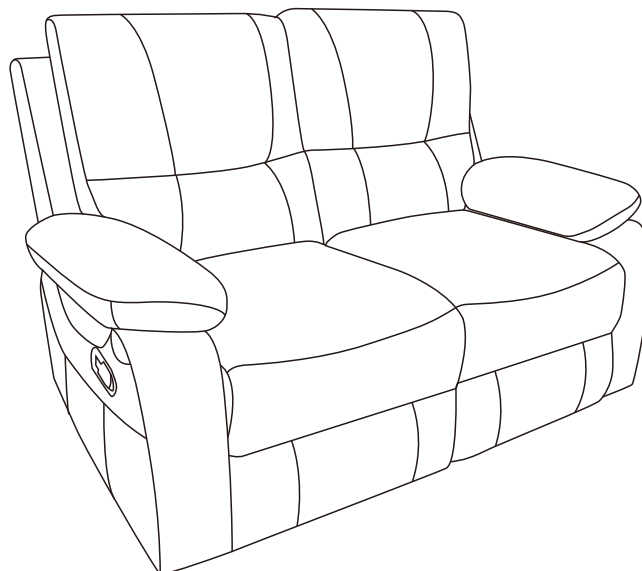

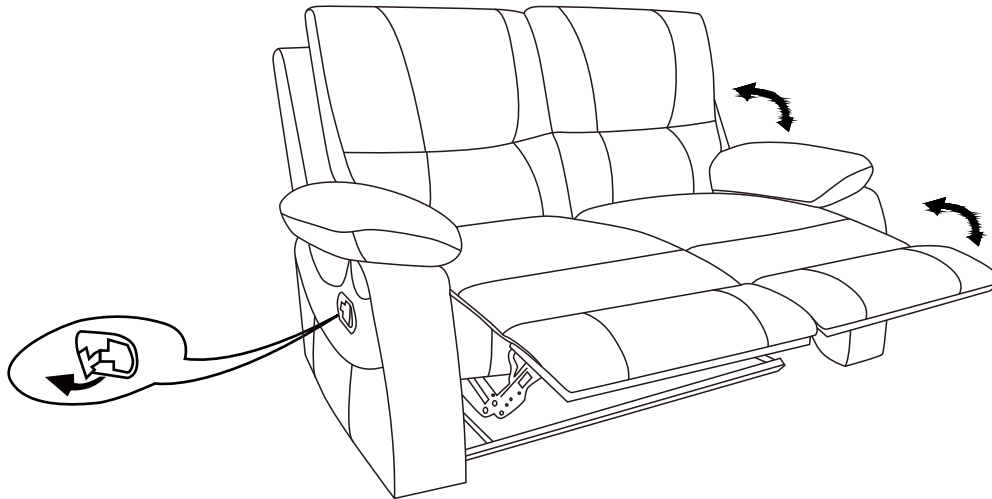

### Care Instruction for PU Furniture.

In order to maintain the original appearance of your PU furniture, please follow below simple care procedures:

- Avoid exposing furniture directly to sunlight or heating and air conditioning outlets. Sunlight and/or exposure to heating and air conditioning outlets will fade/damage PU.
- Do not place your upholstered furniture too close to windows, radiators, or vents and be sure to use window, radiators, or vents.
- Vacuum or wipe with a soft brush to remove dust.







- For items used on wooden floor, hard surfaces or carpets, it is recommended to install protective pads
- under all legs supports to avoid/prevent from damages/scratches discoloration.

## ASSEMBLY INSTRUCTION DOUBLE RECLINING SOFA

The Metal pin are all wrapped together and placed on the back of the armrest

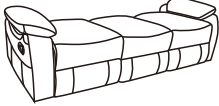
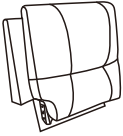
**NOTE:** Do not use power tools for assembly. Power tools increase the risk of over tightening which leads to splitting or cracking the wood.

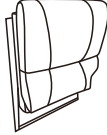
### COMPONENT LIST (SOFA)

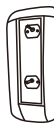
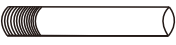
NO.	DRAWING	QTY	DESCRIPTION
A		1	SEAT
B		1	LSF BACK REST
C		1	MIDDLE BACK REST
D		1	RSF BACK REST
E		1	LSF ARMREST
F		1	RSF ARMREST
G		4	METAL PIN

**STEP# 1**

Insert metal pins (G) to the pre-drilled holes on both arms, turn clockwise to tighten it. Attach and insert both arms(E & F) onto the handrail, push to the end and make sure the metal pins is locked in place properly.

**Step#2**

Attach LSF Back Rest (B) and RSF Back Rest (D) and Middle Back Rest(C) to the Seat(A)

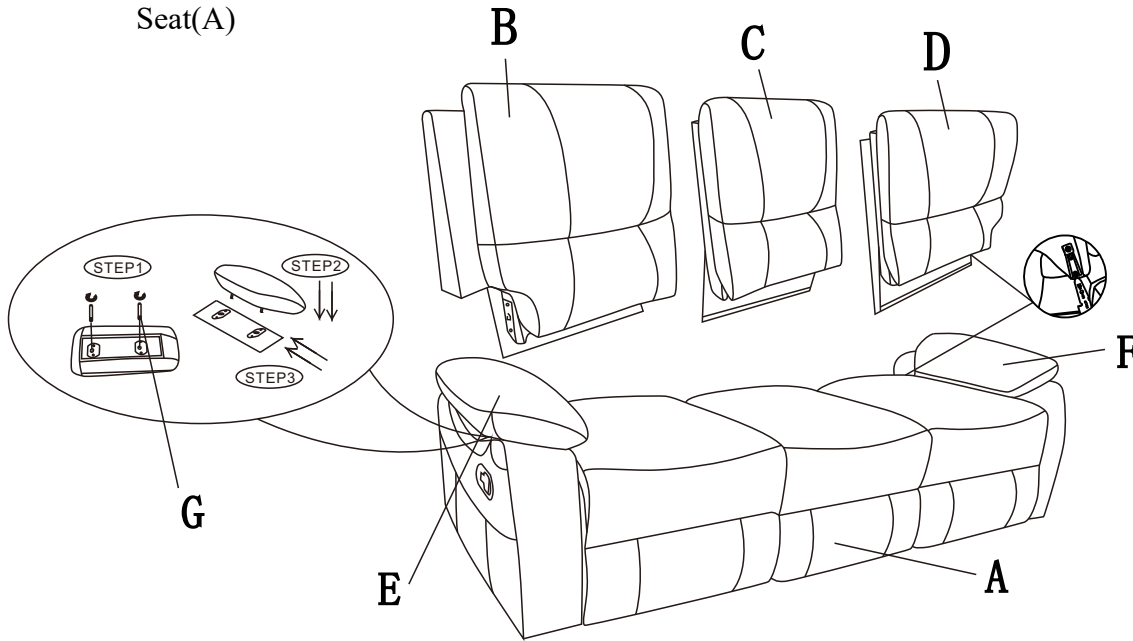

**STEP#2 Completed**

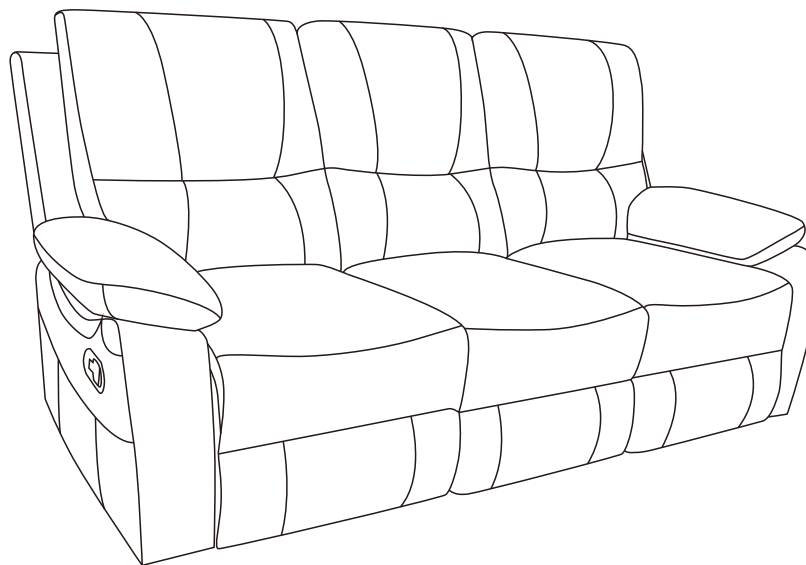

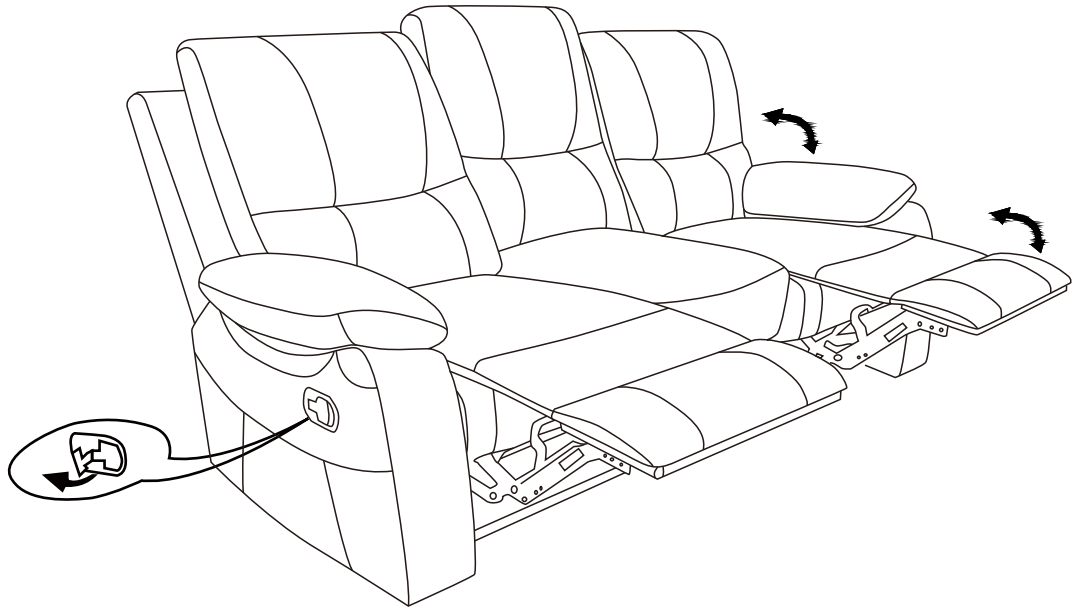

## Care Instruction for PU Furniture

In order to maintain the original appearance of your PU furniture, please follow below simple care procedures:

- Avoid exposing furniture directly to sunlight or heating and air conditioning outlets. Sunlight and/or exposure to heating and air conditioning outlets will fade/damage PU.
- Do not place your upholstered furniture too close to windows, radiators, or vents and be sure to use window, radiators, or vents.
- Vacuum or wipe with a soft brush to remove dust.



For items used on wooden floor, hard surfaces or carpets, it is recommended to install protective pads under all legs supports to avoid/prevent from damages/scratches discoloration.