

# ASSEMBLY INSTRUCTION

---

## **Friendly Reminder:**

**1. This sofa is packed in 4 boxes. Please assemble it After all boxes are received.**

**2.As the cushions are all vacuum compressed, there will be some wrinkles. Please give your cushions up to 72 hours to reach its original size and the wrinkles will basically disappear.**

**3.Please do not open the compressed packags until your sofa frame is completely assembled.**

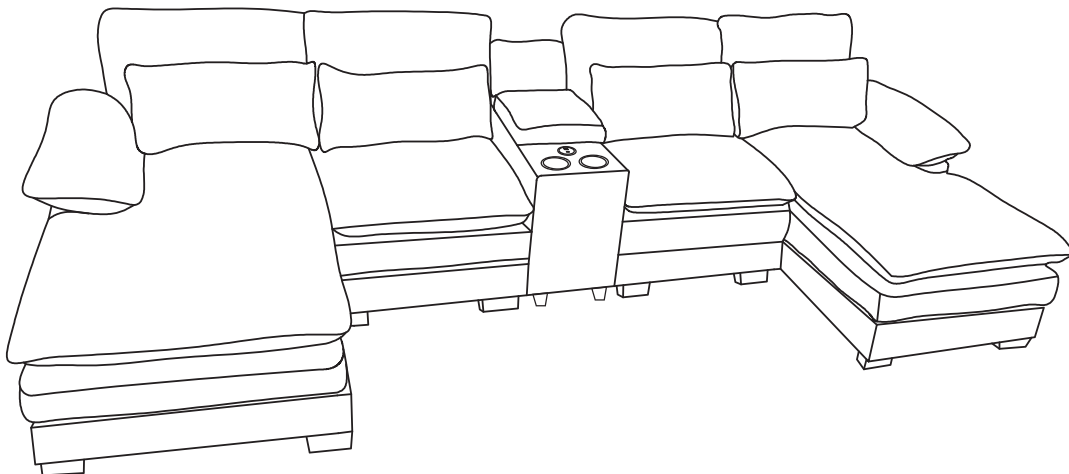

# COMPONENTS

## BOX 1

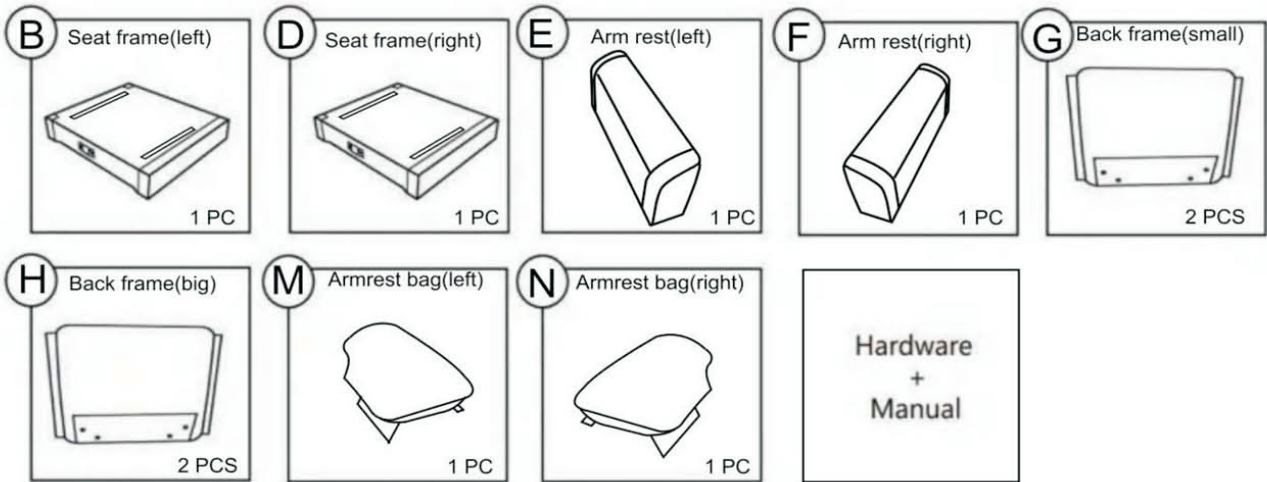

## BOX 2

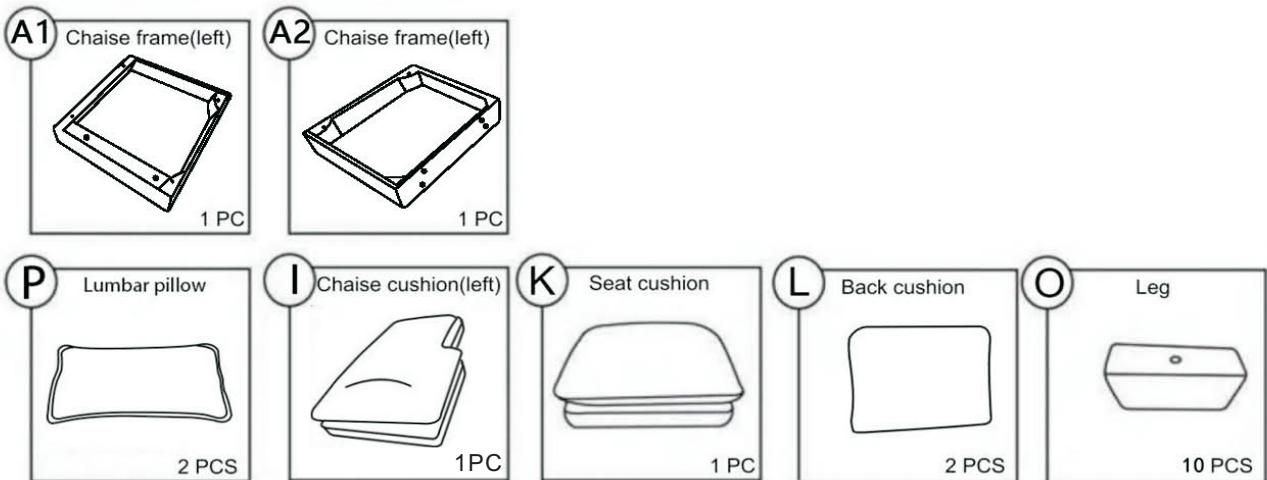

## BOX 3

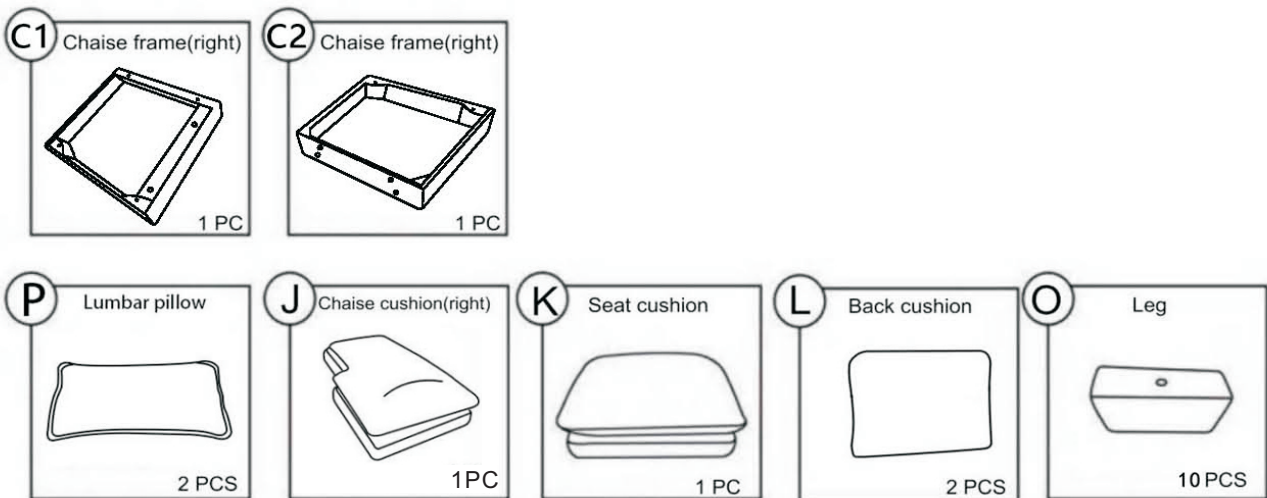

## BOX4

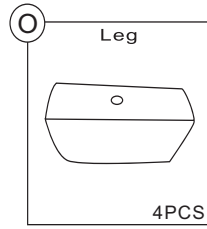
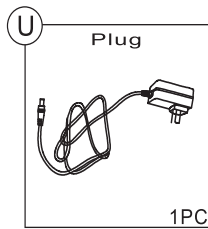
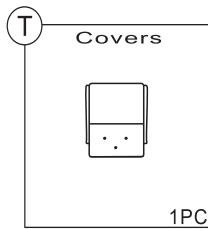
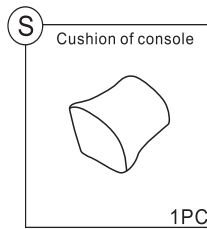
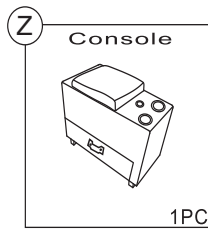

Hardware  
+  
Manual

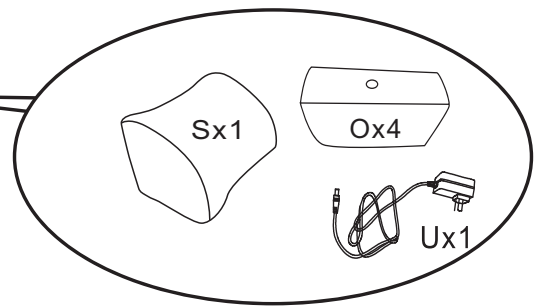
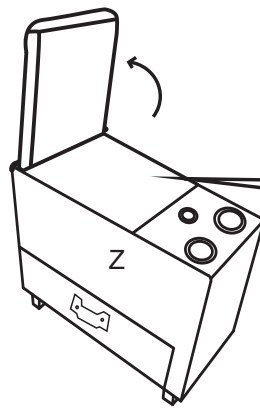

## COMPONENTS

### Hardware Package

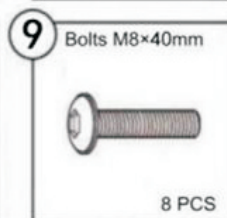
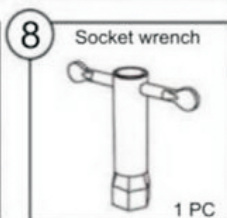
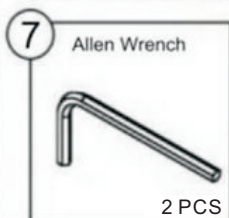
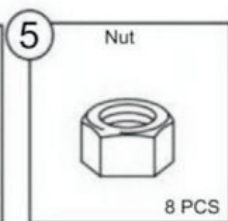
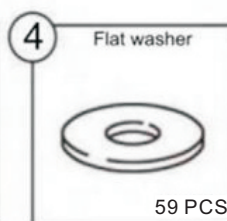
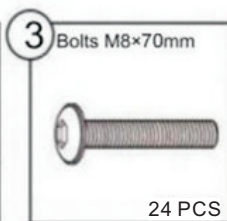
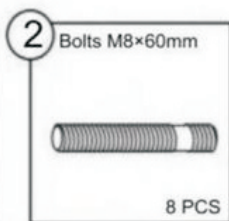
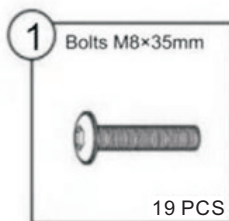

**Note: Remove all parts from 4 boxes and make sure all parts are received before assembly**

DIAGRAM 1

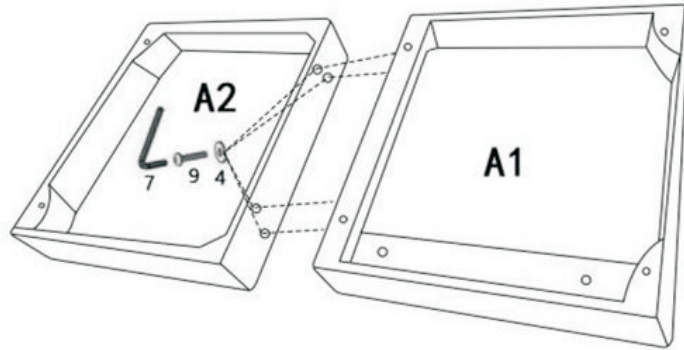

4		8PCS
9		8PCS
7		1PC

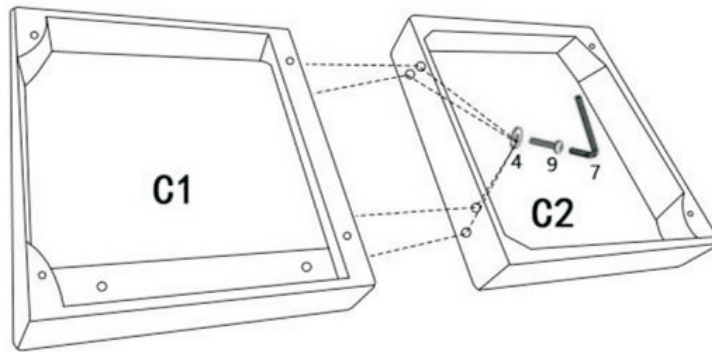

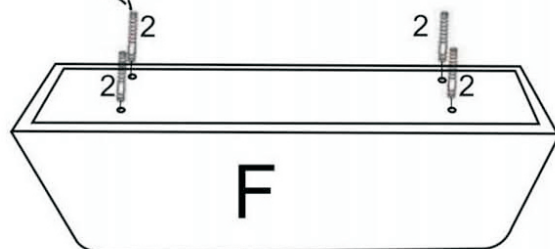
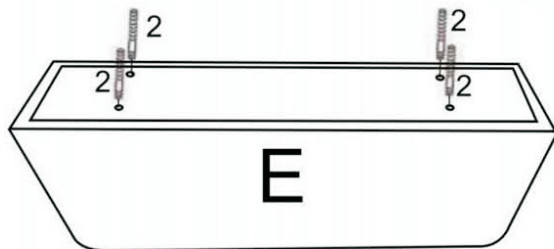
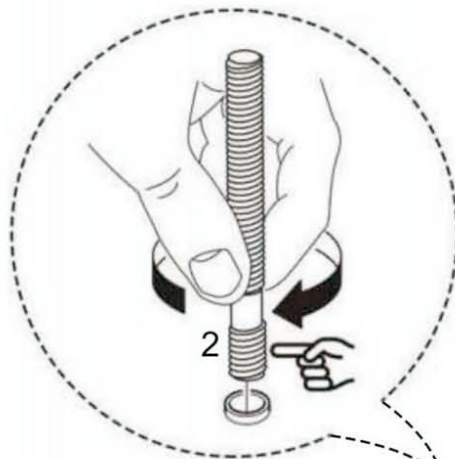





DIAGRAM 2 (Assemble the Armrest(PartsE&F))

Screw the Bolts (Parts 2) into the screw holes on the bottoms of the Armrest(PartsE&F) as shown.

2		8PCS
---	---	------





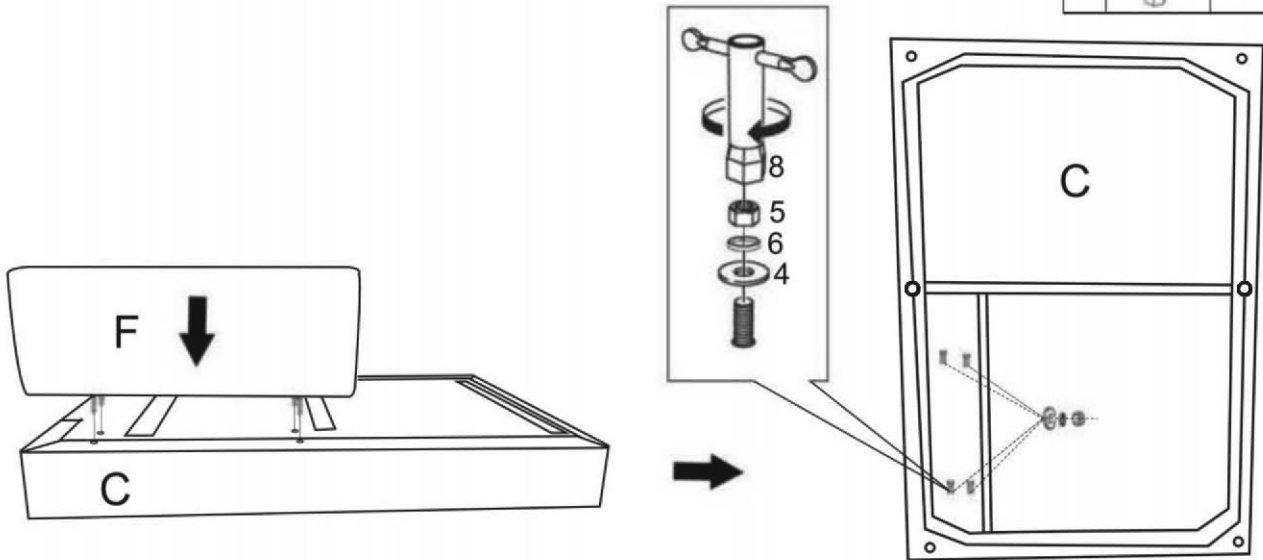

**DIAGRAM 3 (Assemble the Armrest(right) to the Chaise frame (right))**  
 Connect the Armrest(right) (Parts F) to the Chaise frame(right) (Parts C) with the Bolts M8X60mm (Parts 2) ,the Flat washer (Parts4) ,the nuts(Parts 5) and the Spring washer(Parts 6) by Socket wrench (Parts 8).

4		4PCS
5		4PCS
6		4PCS
8		1PC



**DIAGRAM 4 (Assemble the Armrest(left) to the Chaise frame (left))**  
 Connect the Armrest(left) (Parts E) to the Chaise frame(left) (Parts A) with the Bolts M8X60mm (Parts 2) ,the Flat washer (Parts4) ,the nuts(Parts 5) and the Spring washer(Parts 6) by Socket wrench (Parts 8).

4		4PCS
5		4PCS
6		4PCS
8		1PC

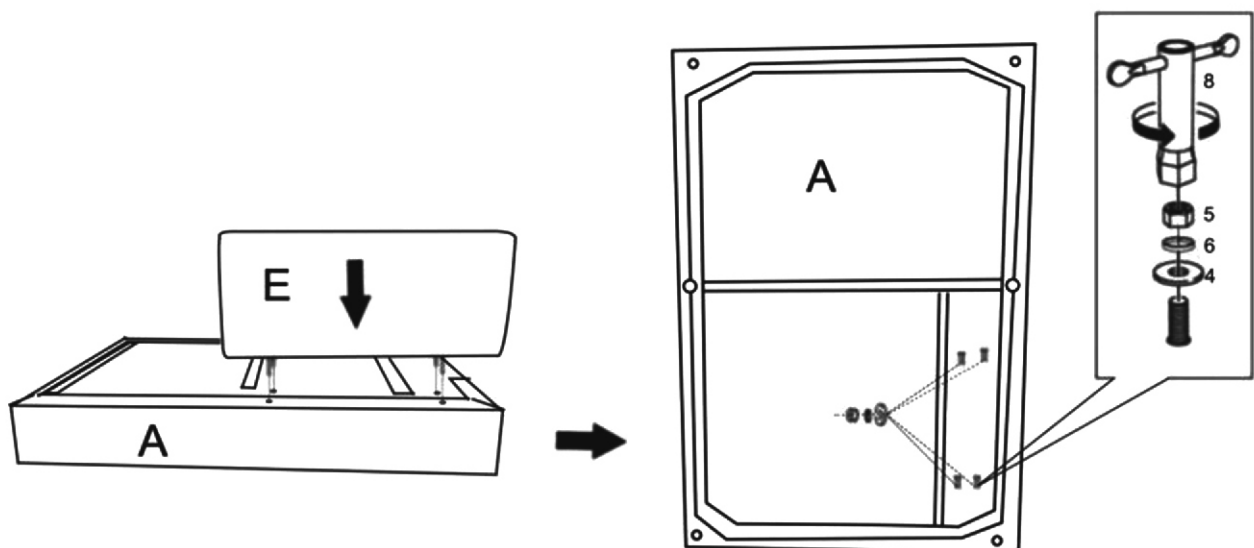





DIAGRAM 5(Assemble the Legs)

Tighten 6 Legs (Parts O) with Bolts(Parts3) and Flat washer(Parts 4)as shown.

4		6PCS
3		6PCS
7		1PC
O		6 PCS

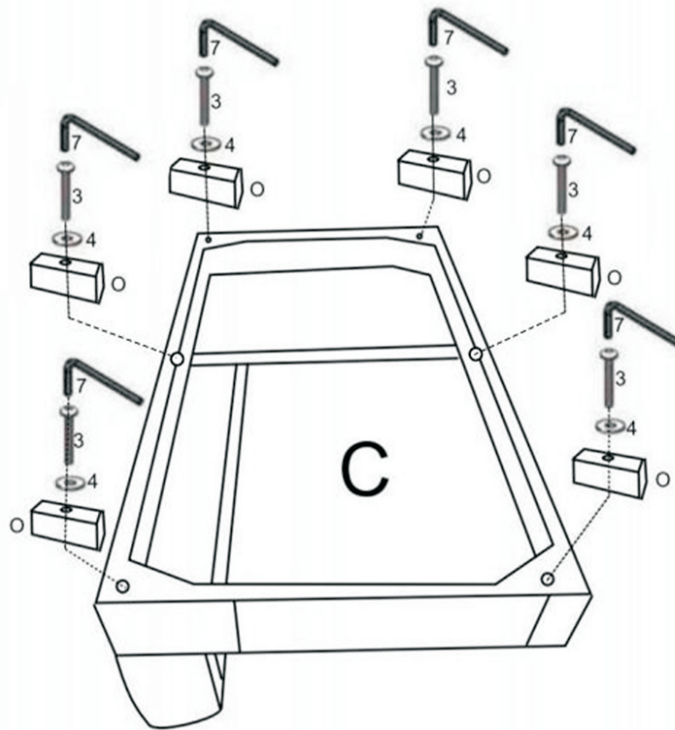



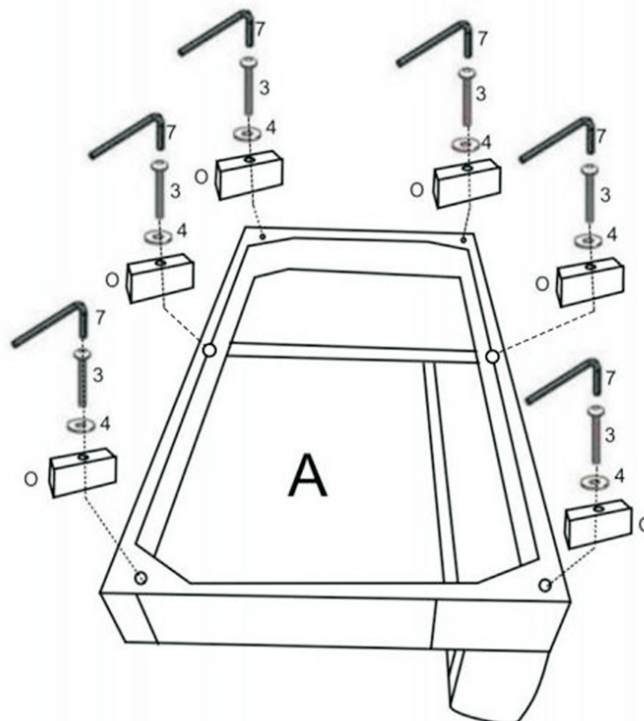

DIAGRAM 6(Assemble the Legs)





Tighten 6 Legs (Parts O) with Bolts(Parts3) and Flat washer(Parts 4)as shown.

4		6PCS
3		6PCS
7		1PC
O		6PCS



**DIAGRAM 7 (Assemble the Legs)**

Tighten 8 Legs (Parts O) with Bolts(Parts3) and Flat washer(Parts 4)as shown.

4		12PCS
3		12PCS
7		1PC
O		12PCS

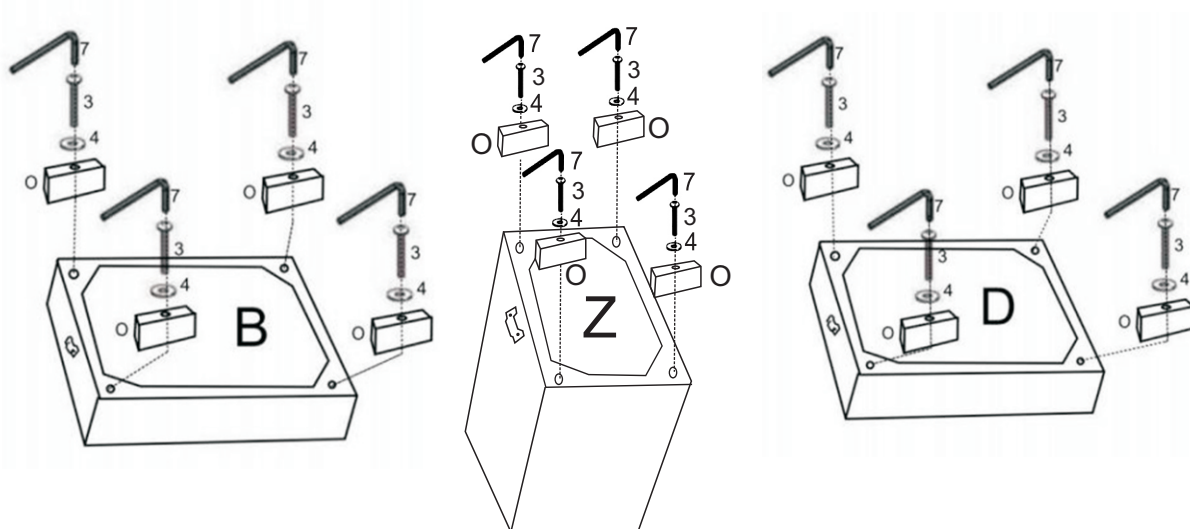

**DIAGRAM 8 (Assemble the Back frame)**

Connect the Back frame(Parts G) using (4) M8×35mm Bolts (Parts 1) and(4) Flat washer (Parts 4) by Wrench(Parts 7) as shown.Then put Velcro pieces together.

4		4PCS
1		4PCS
7		1PC

Please install the top Bolts first, then the bottom Bolts.

Make sure all the Bolts are in the holes before tightening all the Bolts.

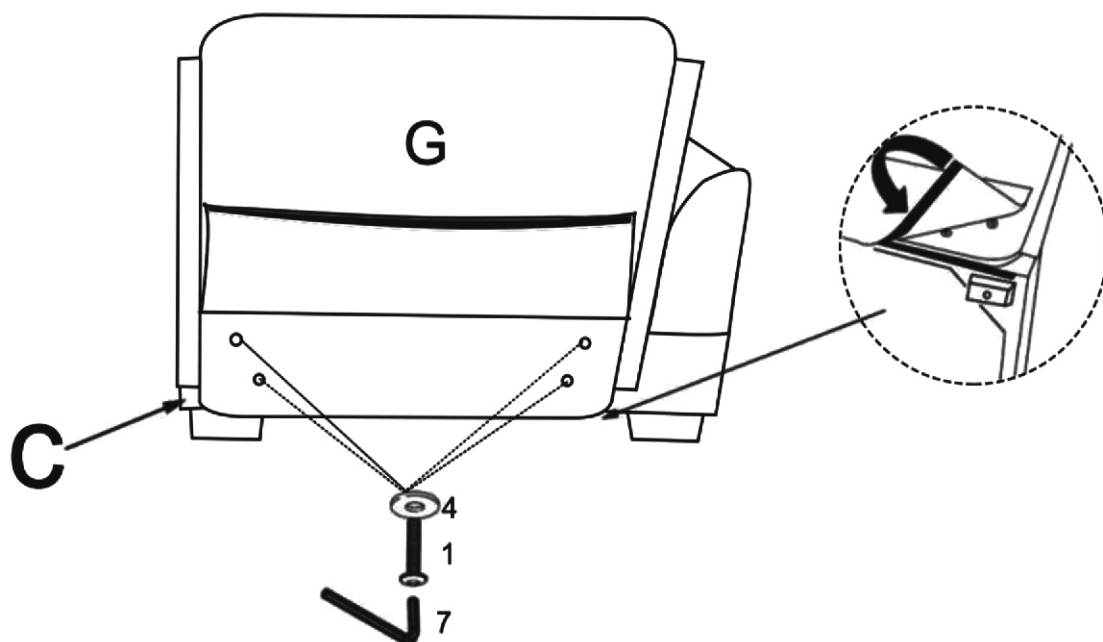



**DIAGRAM 9 (Assemble the Back frame)**

Connect the Back frame (Parts H) using (4) M8×35mm Bolts (Parts 1) and (4) Flat washer (Parts 4) by Wrench (Parts 7) as shown. Then put Velcro pieces together.

Please install the top Bolts first, then the bottom Bolts.

Make sure all the Bolts are in the holes before tightening all the Bolts.

4		4PCS
1		4PCS
7		1PC

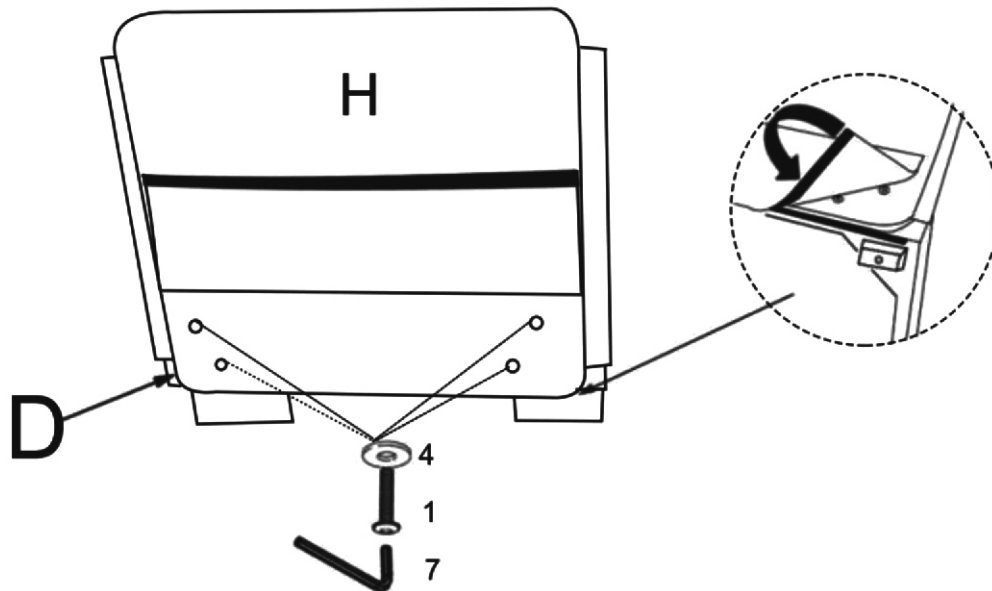

**DIAGRAM 10 (Assemble the Back frame)**

Connect the Back frame (Parts H) using (4) M8×35mm Bolts (Parts 1) and (4) Flat washer (Parts 4) by Wrench (Parts 7) as shown. Then put Velcro pieces together.

Please install the top Bolts first, then the bottom Bolts.

Make sure all the Bolts are in the holes before tightening all the Bolts.

4		4PCS
1		4PCS
7		1PC

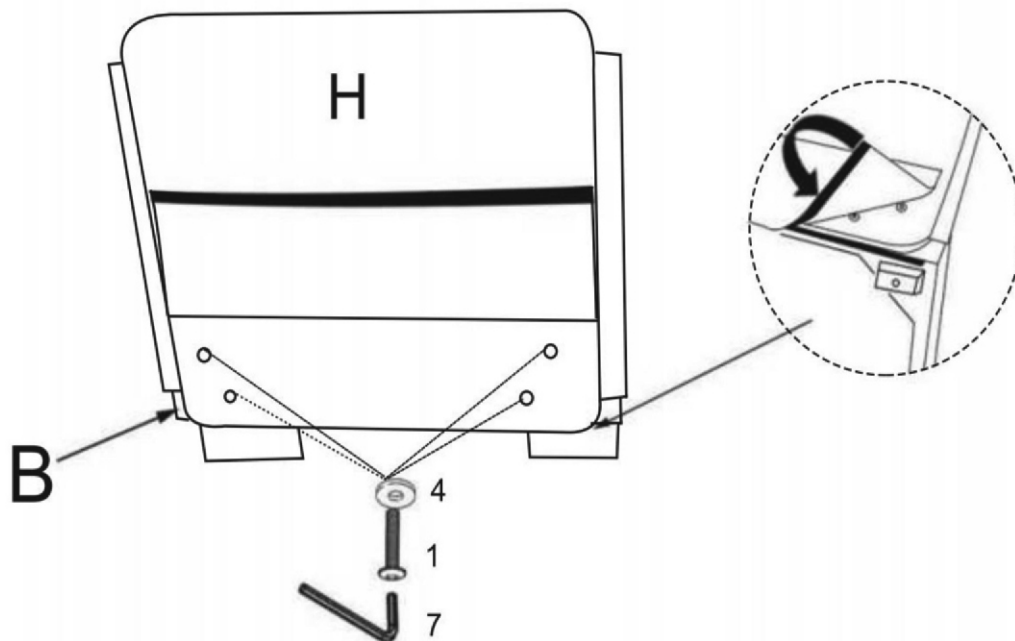



**DIAGRAM 11** (Assemble the Back frame)

Connect the Back frame(Parts G) using (4) M8×35mm Bolts (Parts 1) and(4) Flat washer (Parts 4) by Wrench(Parts 7) as shown.Then put Velcro pieces together.

Please install the top Bolts first, then the bottom Bolts.

Make sure all the Bolts are in the holes before tightening all the Bolts.

4		4PCS
1		4PCS
7		1PC

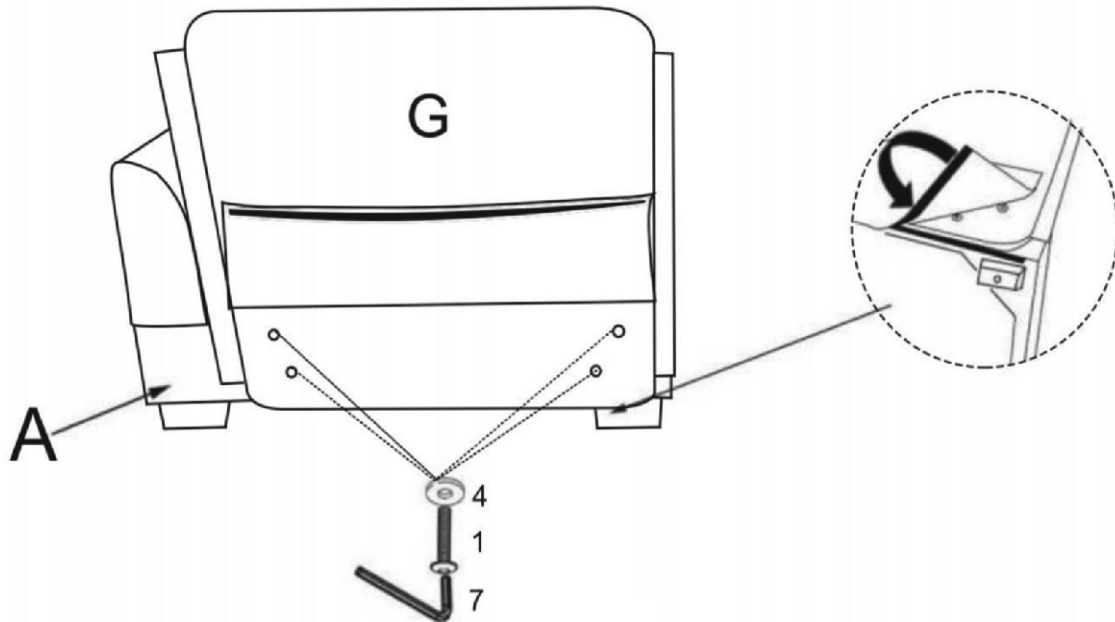



**DIAGRAM 12**(Assemble the Back frame)

Connect the Back frame (Part T) and the Back frame of console(Part 3) using (11) M8×35mm Bolts (Part1) and (4) Flat washer (Part 4) by Wrench(Part 9) as shown.

Please install the top Bolts first, then the bottom Bolts.

Make sure all the Bolts are in the holes before tightening all the Bolts.

1		3PCS
4		3PCS
7		1PCS

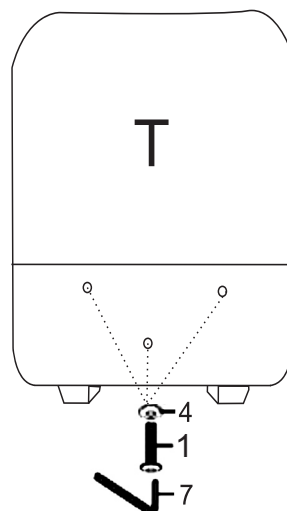
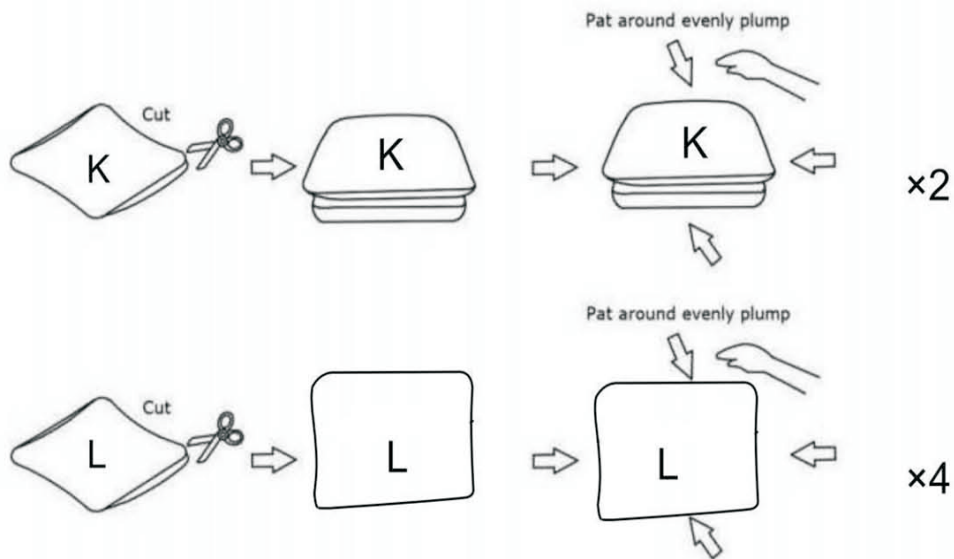

DIAGRAM 13 (Removal of compression bags)

Remove the Seat cushion (Parts K ) Back cushion(PartsL).



TIPS:

72h

1. Please do not open the compressed packages until your sofa frame is completely assembled.
2. Compressed Chaise cushions need to be fully fulfilled within 72 hours for your perfect use.
3. Please keep children away from plastic bags or any small pieces of stuff.

DIAGRAM 14 (Removal of compression bags)

Remove the Chaise cushion (Parts I&J) .

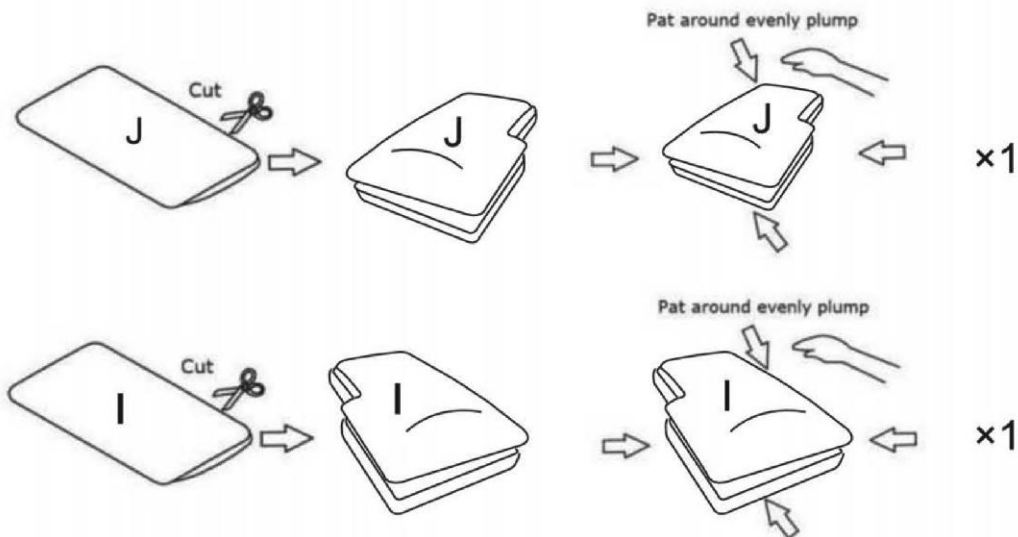

TIPS:

72h

1. Please do not open the compressed packages until your sofa frame is completely assembled.
2. Compressed Chaise cushions need to be fully fulfilled within 72 hours for your perfect use.
3. Please keep children away from plastic bags or any small pieces of stuff.

**DIAGRAM 15(Connecting the Seat frame)**

Connect the Chaise frames(Part A&B) and the Seat frames(Parts C) to the Console(Part D) as shown.

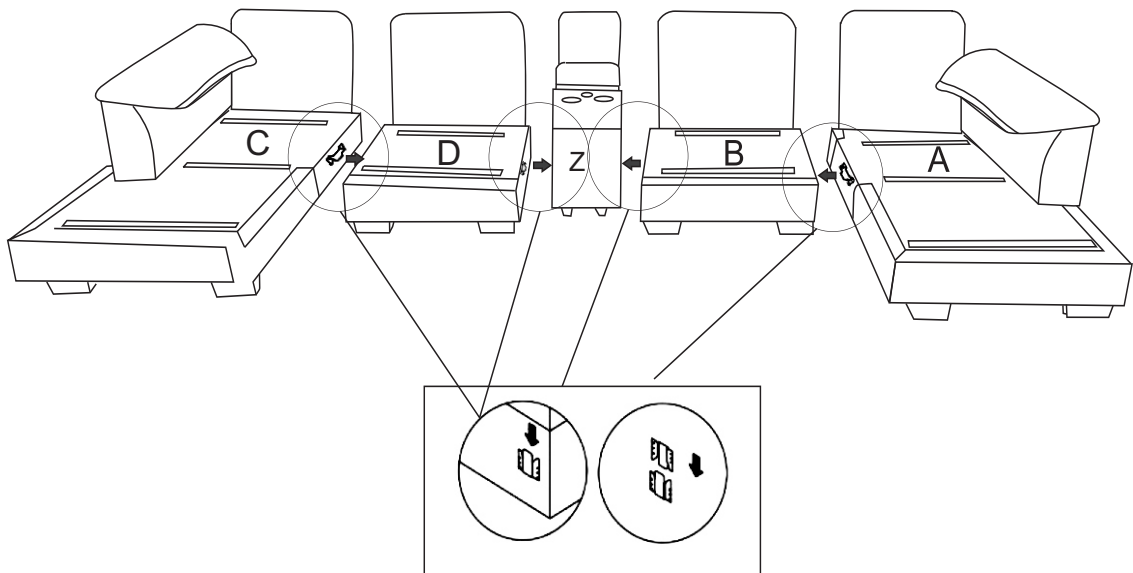

**DIAGRAM 16(Connecting the Armrest bags)**

Insert Armrest bag(left)(Parts M) into the Armrest(left)(Parts E) and Insert Armrest bag(right)(Parts N) into Armrest(right)(Parts F)

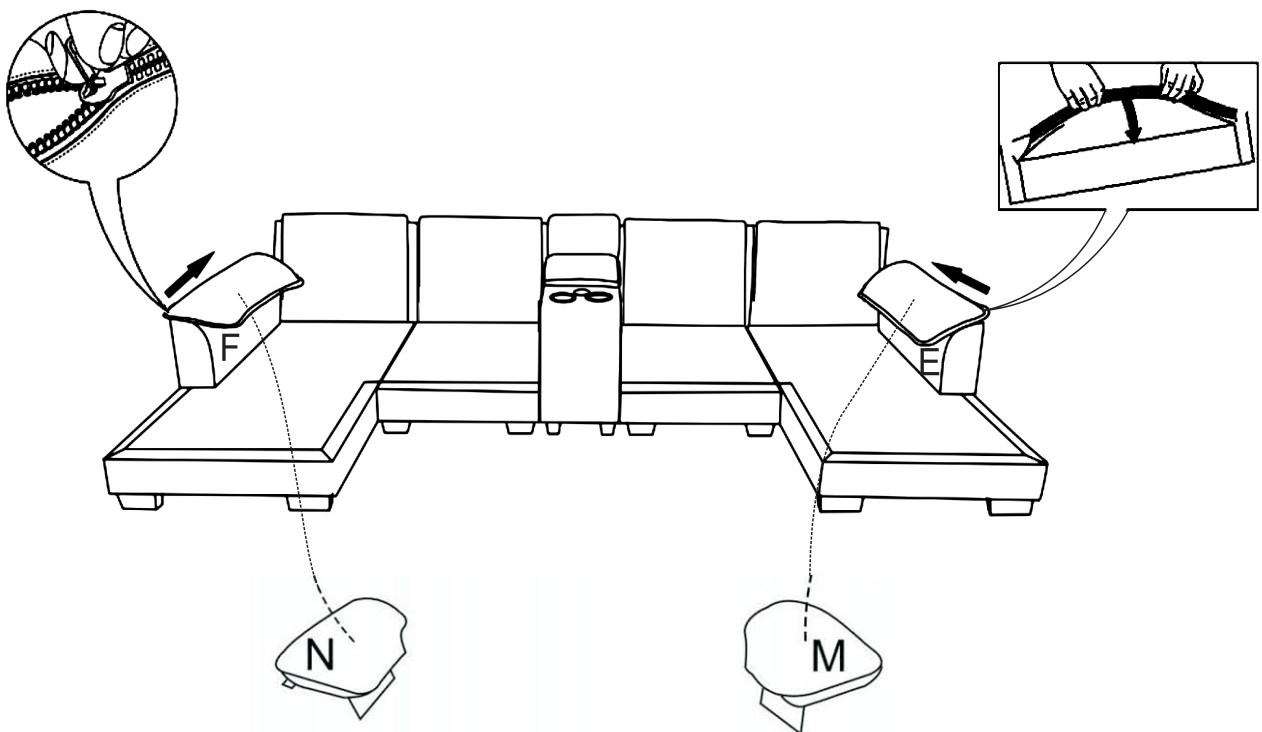
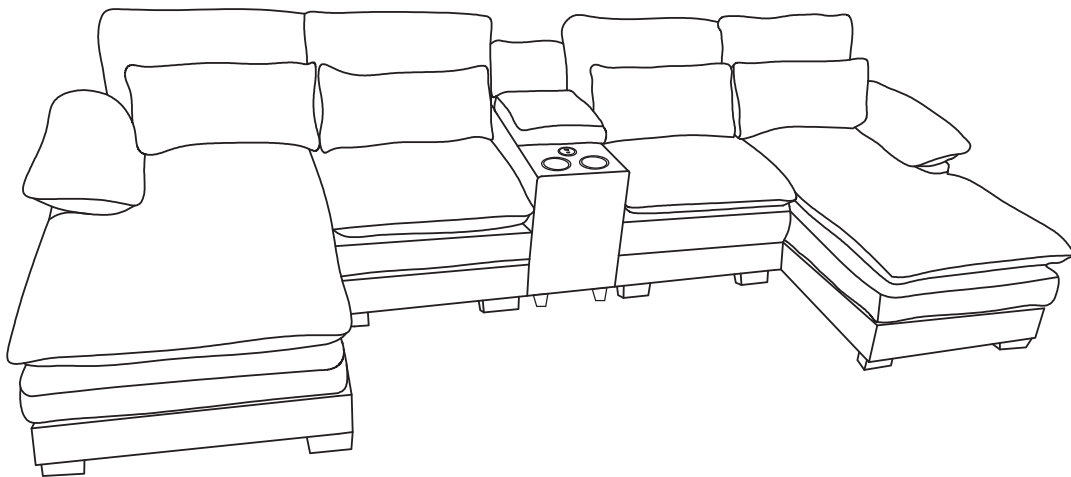
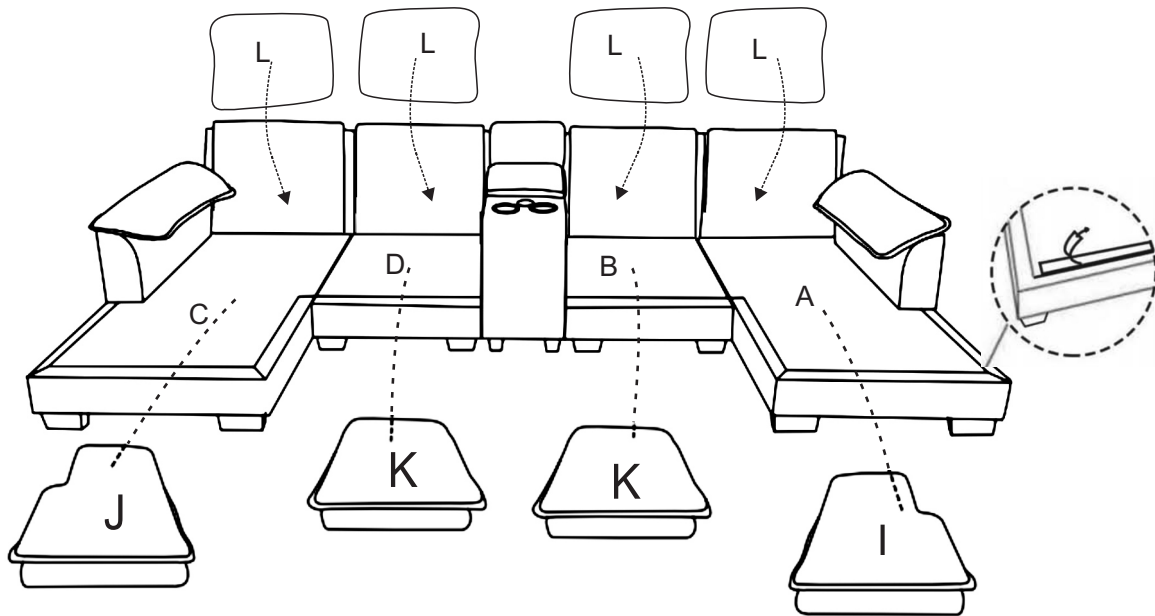

DIAGRAM 17( Place the Chaise cushion ,Seat cushion,Back cushion on the sofa)  
Tear off the Velcro protective cloth,the put the Seat cushion (Parts K) the Chaise cushion (PartsJ&I) the Back cushion(PartsL) on the sofa.Recheck all the bolts before you sit on the sofa.



**COMPLETE!**