

K1333 Installation Instruction --- and User Manual

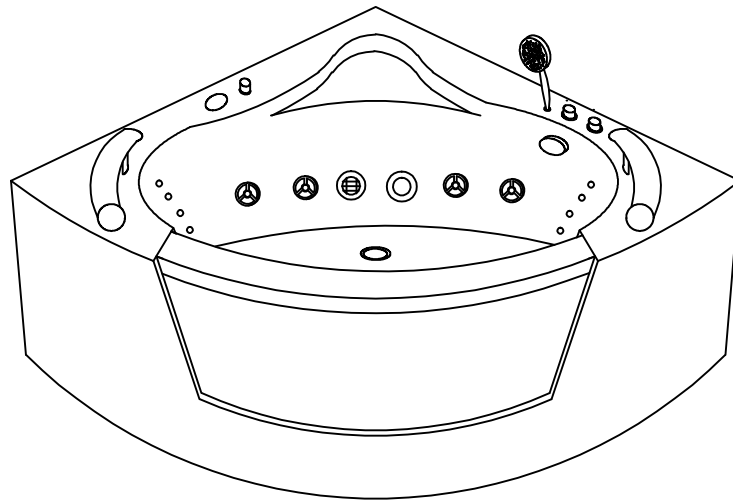

Please read this manual carefully before using.

Safety instructions

1. This appliance is not intended for use by persons (including children) with reduced physical, sensory or mental capabilities, or lack of experience and knowledge, unless they have been given supervision or instruction concerning use of the appliance by a person responsible for their safety.
2. Children should be supervised to ensure that they do not play with the appliance.
3. Connection requirement:
The appliance must be fitted with means for disconnection from the supply mains having a contact separation in all poles that provide full disconnection under overvoltage category III conditions and these means must be incorporated in the fixed wiring in accordance with the wiring rules.
4. the pressure of water 0.1MPa~0.4MPa.
5. 5.1: earthed appliances must be permanently connected to fixed wiring;
5.2: parts incorporating electrical components, except remote control devices, must be located or fixed so that they cannot fall into the bath;
5.3: the appliance should be supplied through a residual current device (RCD) having a rated residual operating current not exceeding 30 mA.
5.4: parts containing live parts, except parts supplied with safety extra-low voltage not exceeding 12 V, must be inaccessible to a person in the bath;

Tools

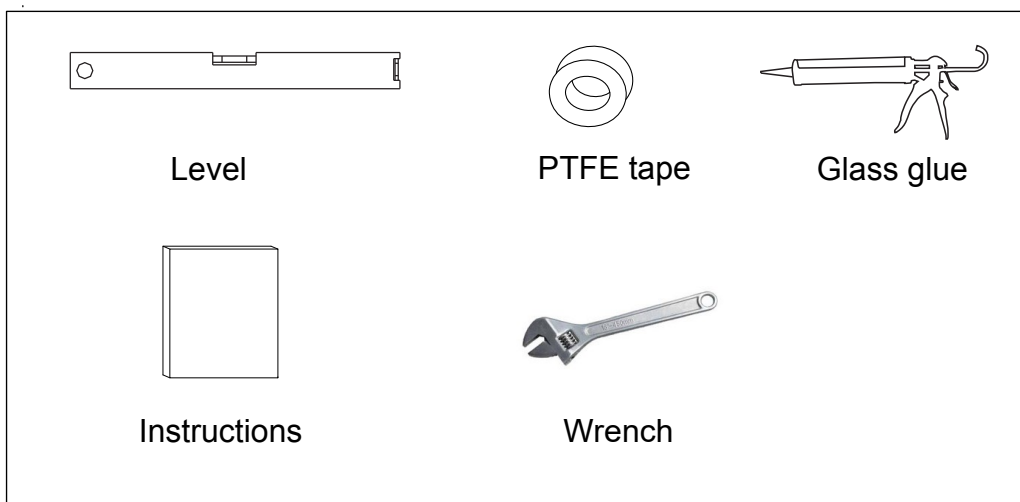

1.Safety notice:

- Cardiopathy, hypertension and person who is unwell or after drinking, please do not use the massage bathtub to avoid risk happening.
- Children should be accompanied by the adult while using the massage bathtub.
- Power plug must be assembled with creepage protector and connected with the terra wire, and follows the rules to operate. Power socket must be installed out of reach of water.
- The massage bathtub must be assembled by the careerman.
- When switch on the hand shower and inlet faucet, please adjust the suitable water temperature firstly, to avoid scalding and destroy the products.
- Advisable water temperature: lower 60°C.

2.Usage instruction:

- Press the Power On/Off button on the Digital Controller to turn on power.
- Use the Hand shower VS Inlet Faucet Selector to select Inlet Faucet to fill the tub (during bathing, you can select hand shower for showering). Turn the Hot and cold water mixing valve to fill water in and tune an appropriate water temperature for bathing. (Forbid to fill hot water above 140°F or it will damage the tub).
- Fill the bathtub till the water line is 1 inch above the higher jet nozzles.
- Use the Digital Controller to turn on Hydro Massage, Warmth-keeping, RGB Lighting at user's will. If Hydro Massage is in use, please tune Hydro Massage Intensity and Bubble Volume Regulator (Massage intensity higher then bubbles are more).
- If you will not use the massage bathtub for a long time, please cut off the power source and power off massage bathtub.

3.Installation Steps:

- Level the ground and wall corner, connect cool & hot water hose correctly, assemble wire terminals and referring to the size parameter to prepare the drain outlet.
- Place the massage bathtub in the confirmed position, adjust all the tub feet to make them meeting the ground and levelling.
- Throw a spot of water into the bathtub, turn on the drainer, check the draining is fine as all water should be drained. If not, please check point 2.
- Connect the cool & hot water pipe correctly, insert the draining hose into the drainer, wiring the terminals correctly.

- Examine all the functions (Referring to below introduction of components and digital controller)

4.Maintenance:

- Daily cleaning with general liquid scour, please do not clean the bathtub with doughty acid, doughty alkali, latex , acetone and the chemical which containing methacrylic, formaldehyde, or it will make the bathtub face paled, or destroy the bathtub.
- Polish the face scar with 1000# levigation sand paper firstly, then polish with 1500# sand paper, polishing with soft cloth and toothpaste at last.
- Clean away the scale on the bathtub face with citric acid or vinegar.
- Scrape the stubborn blotch with sort cloth and toothpaste.
- After using for a long time, you can renew the bathtub with luster wax.

5.Trouble-shooting:

Fault	Fault analyzing	Fault obviating
Pumps no work	1.the air hose which connected with the air pump switch was loosened	Connect anew correctly.
	2.air pump switch was broken.	change
	3.power plug haven't been inserted correctly or power fault.	Obviate the supply of power fault.
	4.the water pump's impeller was locked by some sundries.	Take down the water recycle net and `clean away the sundries.
	5. the water pump was broken.	Change a new water pump.
Surfing can not adjust	1. Surfing adjustor was broken.	Change the sealed gasket inside the adjustor
	2.The air hose of surfing adjustor loosen, leak air or jam.	Dredge and connect a new correctly.
Make water	1. sealed washer aging and broken.	Change
	2.locked nut loosened.	Belock anew.
	3.connecting parts' latex aging.	Cleanwaytheoldlatexandconnectwithnewlatere adjustor
Shake acutely	1.grounded parts of bathtub hang in the air.	Adjusting all grounded parts and make them grounded correctly.
	2.water inlet jaming	ake down the water recycle net and clean away the sundries
Water pump works but the bottom light is not light	1.bathtub bottom light short circuit	Obviating the circuitry fault
	2. bathtub bottom light is broken	Change the bathtub bottom light (forbid increasing power)
	3.transformer is broken.	Change the transformer(forbid minishing the rated power.)

6.H/C mixing valve connection:

Hot and cold water mixing valve

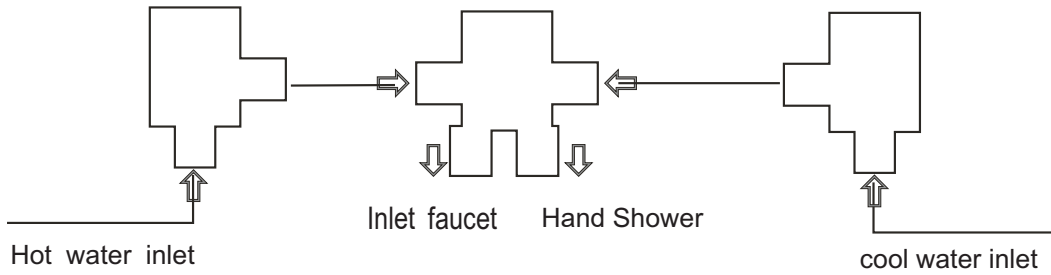

7.Electric diagram:

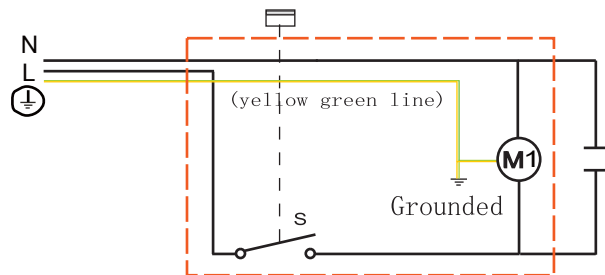

S ----- pump switch

M1 ----- water pump

8.Water and electric installation illustration :

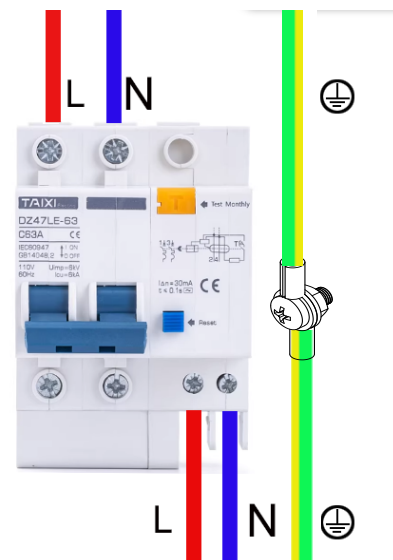
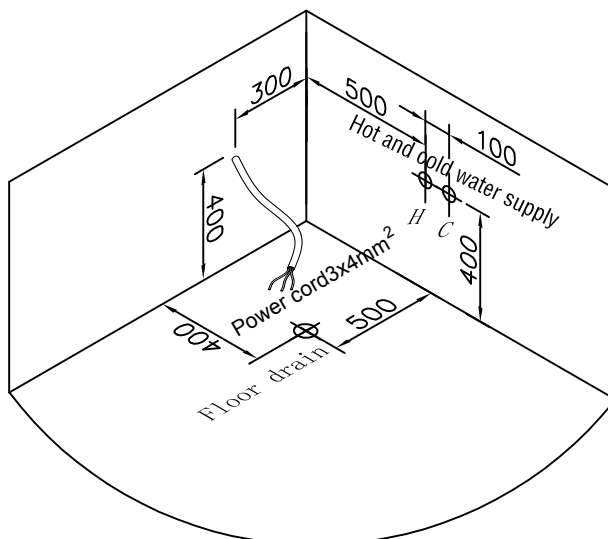

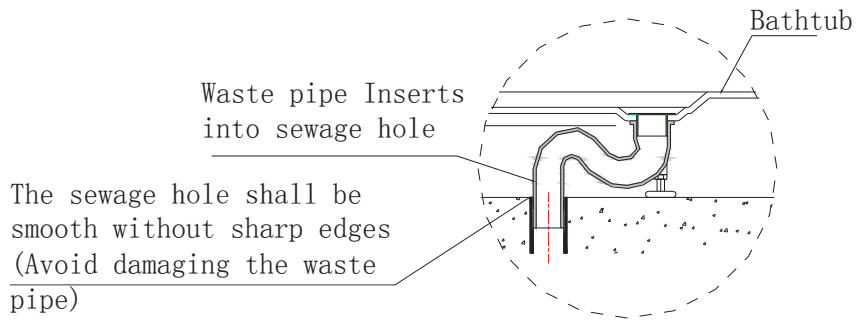

During installation, please avoid harming the waste pipe with sharp objects (e.g. knife).

9.Key Components:

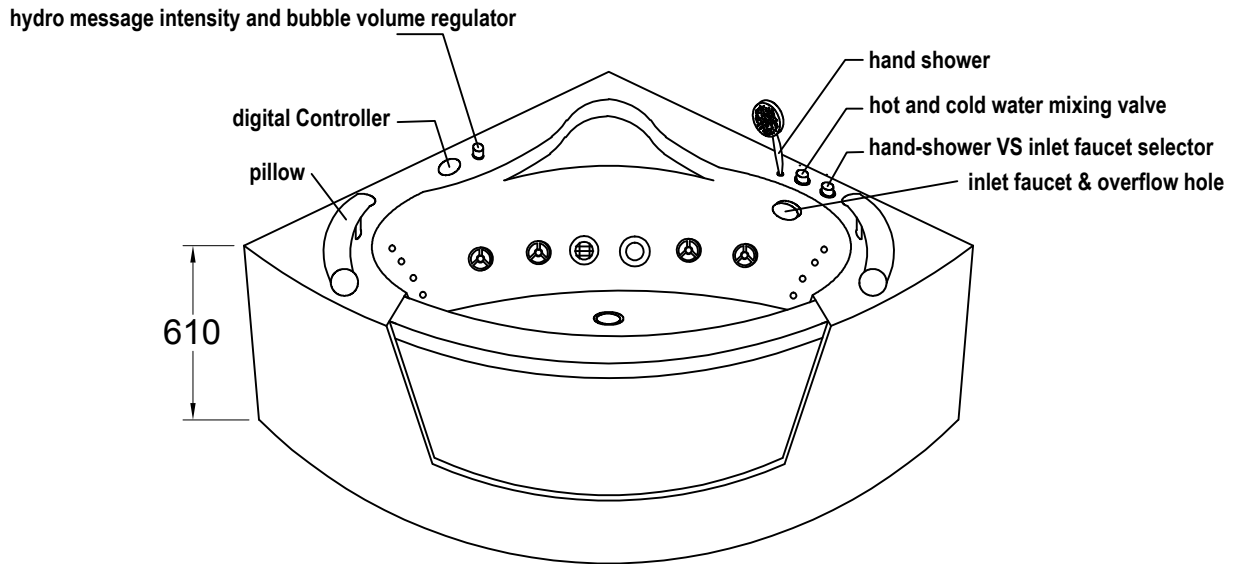

Reference size

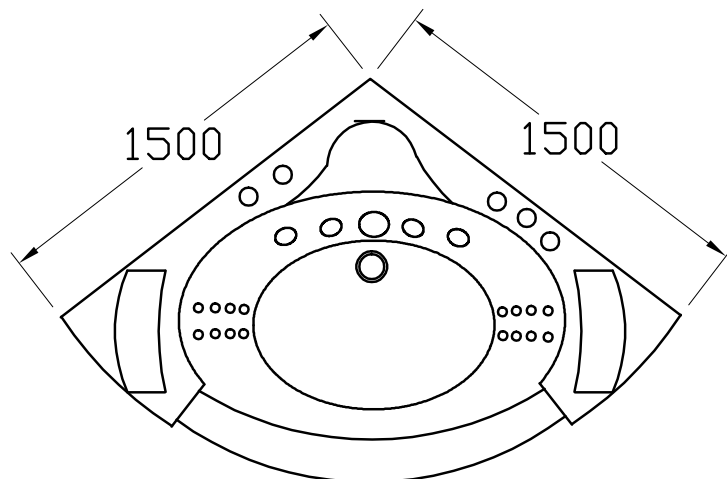



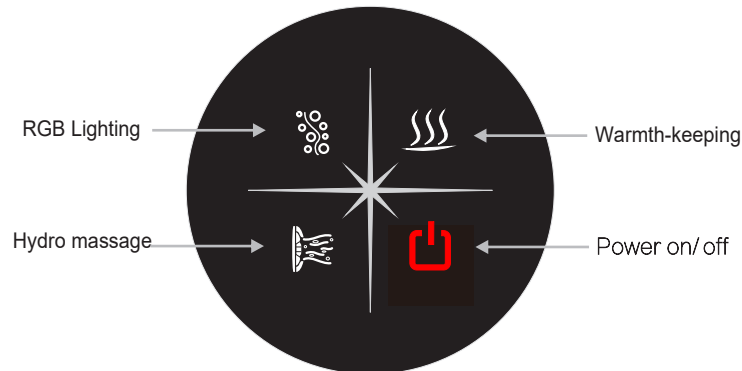

10. Digital Operating instructions:

Digital Controller



(This instruction contrapose the model which has these function ,client can choose the model according his need .)

-  **Power on/off:** the system and indicator light will start after press this button. press again to turn off the system and the indicator light will off.
-  **Hydro Massage:** This function will start only after detecting the water ,and the indicator light will flicker when there is short of water. The pump will turn off automatically after 60 minutes.
-  **Warmth-Keeping:** This function will be work only after start the water pump. when the water pump turn off, the heater will turn off at the same time.
-  **RGB Lighting:** Pressing this button will activate the RGB Led light. Pressing it again will turn it off.

11. Technical data:

- 1、 Power Supply: AC 110V 60Hz **2600W**
- 2、 IP Grade of Waterproof: IPX5